

MARCO[®]
TOOLS
BY SPIN

VALIDITÀ
VALIDITY · VALIDEZ
01/03/2024
31/12/2024



**PROMO
2024**

**AUTOATTREZZATURE
PROFESSIONALI**

PROFESSIONAL GARAGE EQUIPMENT



Cod.	Promo, €	Pag.	Cod.	Promo, €	Pag.	Cod.	Promo, €	Pag.	Cod.	Promo, €	Pag.
01.000.01	4,20	82	01.000.338	39,90	15	03.024.42	1.080,00	65	05.056.08	9,90	115
01.000.08IMP	38,00	80	01.000.339	82,00	16	03.024.43	660,00	65	05.056.09	43,00	117
01.000.37	8,40	82	01.017.05	976,00	81	03.031.01	149,00	99	05.056.12	41,00	115
01.000.39	18,90	82	01.017.06	837,00	81	03.031.16	109,00	99	05.056.16	27,93	118
01.000.100	78,60	80	01.090.00	63,00	81	03.031.32LT	764,00	50	05.056.20	3,90	116
01.000.124	29,90	82	01.090.01	325,00	81	03.031.33	190,00	50	05.058.01	77,90	116
01.000.125	29,50	82	01.090.04	63,00	81	03.031.36	26,00	50	05.058.07	29,50	116
01.000.127	38,50	82	01.090.07	26,00	80	03.031.37	1.295,00	51	05.058.08	10,50	116
01.000.167	P.A.R	82	01.090.08	265,00	79	03.031.38	298,00	100	05.058.09	22,00	116
01.000.168IMP	59,00	80	01.090.10	76,00	81	03.031.39	195,00	100	05.060.00	29,90	161
01.000.187	P.A.R	82	01.090.11	18,00	81	03.031.40	198,00	51	05.060.02	18,50	57
01.000.203.R1	70,00	80	01.090.12	95,00	81	03.032.01	858,00	147	05.060.03	26,00	57
01.000.203M	162,00	80	01.090.13	47,00	80	03.036.01	1.141,00	49	05.060.04J	104,00	57
01.000.207	5,00	82	01.090.15	238,00	80	03.036.04	13,00	111	05.062.00	59,50	111
01.000.208	9,90	82	01.090.16	360,00	80	03.036.17	178,00	77	05.062.00.R1	21,00	111
01.000.214	182,00	81	02.000.101	11,00	76	03.036.25	21,00	119	05.062.01	38,00	119
01.000.215	84,30	89	02.000.43	42,00	76	03.036.26	119,00	49	05.062.02	13,20	111
01.000.215W	86,50	89	02.000.96	110,00	77	03.036.28	98,00	114	05.062.03	13,90	144
01.000.224	162,00	89	02.009.13	139,00	76	03.036.32	320,00	31	05.062.04	14,00	144
01.000.224L	203,00	89	02.009.16	233,00	76	03.036.35ECO	840,00	112	05.062.05	11,90	117
01.000.225	427,00	79	02.009.17	283,00	76	03.036.36	210,00	31	05.062.06	12,00	124
01.000.241	29,50	82	02.009.18	4.800,00	77	03.036.37	269,00	49	05.064.00	84,00	144
01.000.242	27,50	82	02.009.19	5.500,00	77	03.036.39	39,00	114	05.066.02	56,00	145
01.000.252	20,90	82	02.009.22	1.750,00	77	03.036.40	39,00	114	05.066.06PRO	449,00	148
01.000.253	23,90	82	02.009.23	3.800,00	77	03.036.41	330,00	113	05.066.11	P.A.R	151
01.000.254	22,00	82	02.009.24	445,00	76	03.050.00	36,00	56	05.066.13	P.A.R	151
01.000.255	22,70	82	02.009.25	639,00	76	03.050.06	398,00	56	05.066.14	P.A.R	151
01.000.257	262,00	89	02.016.04	69,00	120	04.003.12	188,00	59	05.066.15	P.A.R	151
01.000.258	156,00	153	02.020.05	290,00	120	04.003.13	82,60	59	05.066.16	P.A.R	151
01.000.260	470,00	155	02.022.91	12,00	111	04.003.14	260,00	59	05.066.17	P.A.R	151
01.000.261	10,00	155	02.022.113	136,00	118	04.005.06	145,00	16	05.066.19	P.A.R	151
01.000.267	42,60	81	03.000.38	337,00	101	04.013.05	30,00	58	05.066.20	P.A.R	151
01.000.269	115,00	89	03.000.40	425,00	101	04.014.01	99,00	58	05.066.21	P.A.R	151
01.000.276	13,00	94	03.000.42	79,00	161	04.014.02	298,00	152	05.066.22	P.A.R	151
01.000.278	34,00	85	03.000.45	59,00	101	04.018.05	321,00	146	05.066.23	100,00	150
01.000.279	1,95	84	03.000.47	9,90	103	04.018.06	65,00	146	05.066.27	P.A.R	151
01.000.280	31,50	85	03.000.49	29,00	165	04.019.02	576,00	146	05.066.28	P.A.R	151
01.000.281	159,00	85	03.000.50	2.590,00	105	04.024.01	119,00	121	05.066.28.R1	P.A.R	151
01.000.282	12,95	95	03.000.51	2.990,00	105	04.024.02	175,00	121	05.066.28.R2	P.A.R	151
01.000.283E	282,00	86	03.000.52	92,00	102	04.029.01	38,00	122	05.066.28.R3	P.A.R	151
01.000.284	12,29	95	03.000.54	139,00	102	04.042.00	29,00	144	05.066.28.R4	P.A.R	151
01.000.286	145,00	87	03.001.06	990,00	99	04.042.01	29,00	144	05.066.29PRO	569,00	149
01.000.286.R2	32,00	87	03.015.00	267,00	39	04.043.00	69,00	122	05.066.30	1.950,00	150
01.000.294	15,57	95	03.015.03	188,00	43	04.043.01	27,00	122	05.066.30.R1	136,00	150
01.000.295	195,00	96	03.015.04	353,00	43	04.051.00	39,00	154	05.066.30.R2	136,00	150
01.000.296	68,00	96	03.015.11	592,00	41	04.051.01	42,00	154	05.066.30.R3	136,00	150
01.000.297	47,00	87	03.016.00	419,00	39	04.051.02NEW	239,00	154	05.066.30.R4	136,00	150
01.000.299	P.A.R	88	03.016.02	338,00	41	04.052.00	5,95	58	05.067.01	39,00	119
01.000.300	299,00	90	03.017.01	328,00	43	04.052.06	75,00	97	05.073.21	4,50	161
01.000.300.R1	10,00	90	03.018.01	949,00	40	04.052.07	32,00	152	05.073.22	4,98	161
01.000.300.R2	40,00	90	03.019.01	1.115,00	40	04.053.00	49,80	123	05.073.24T	22,50	69
01.000.306	49,00	86	03.019.02	1.082,00	42	04.053.01	72,00	123	05.073.24TK	64,50	69
01.000.308	435,00	84	03.024.20	536,00	61	04.053.05	350,00	123	05.073.25T	44,00	69
01.000.309	66,50	84	03.024.22	1.230,00	66	04.053.07	39,00	124	05.073.25TK	86,00	69
01.000.310	550,00	78	03.024.30	46,00	63	04.053.08	165,00	122	05.073.28	16,00	70
01.000.311	172,00	79	03.024.31	67,90	63	04.053.09	35,00	122	05.073.29	21,00	70
01.000.319	10,80	81	03.024.32	98,50	63	05.008.01	6,50	144	05.073.30	40,90	71
01.000.320	12,80	81	03.024.33	56,90	63	05.013.03	5,95	144	05.073.35	99,00	55
01.000.333	19,95	15	03.024.34	36,90	60	05.013.04	28,00	57	05.073.38	43,90	69
01.000.334	0,65	15	03.024.37	82,00	60	05.019.03	120,00	115	05.073.39	32,00	72
01.000.335	64,00	15	03.024.38	269,00	48	05.036.04	249,00	114	05.073.40	31,00	72
01.000.336	76,00	16	03.024.40	650,00	46	05.056.03	19,00	117	05.073.42	52,00	55
01.000.337	74,00	15	03.024.41	700,00	46	05.056.07	64,00	117	05.073.43	87,00	55

Cod.	Promo, €	Pag.	Cod.	Promo, €	Pag.	Cod.	Promo, €	Pag.	Cod.	Promo, €	Pag.
05.073.44	53,00	55	05.085.11	74,00	35	05.088.126.	24,00	159	05.090.38	14,00	8
05.073.45	72,00	55	05.085.12	176,00	52	05.088.127.	1.660,00	22	05.090.39	29,50	9
05.073.46	12,50	69	05.085.13	30,00	52	05.088.127.R1	590,00	23	05.090.40	20,00	9
05.073.47	59,00	73	05.085.14	62,80	128	05.088.128.	124,00	30	05.090.41	18,90	9
05.073.48	29,90	92	05.085.16	1.980,00	34	05.088.129.	16,00	163	05.090.42	14,90	8
05.073.49	34,90	73	05.085.17	1.360,00	126	05.088.130.	176,00	104	05.090.43	19,55	9
05.073.52	24,90	71	05.085.18	1.680,00	126	05.088.131/100	3,60	26	05.090.44	16,50	9
05.073.53	76,00	68	05.085.27	2.850,00	33	05.088.131/150	4,00	26	05.090.47	130,00	121
05.074.05	128,00	145	05.085.27.R1	390,00	33	05.088.131/200	4,00	26	05.090.48	34,00	133
05.075.10	382,00	74	05.086.00	139,00	134	05.088.131/25	3,20	26	05.090.49	128,00	130
05.075.11	4,80	75	05.086.05	109,00	134	05.088.131/50	3,20	26	05.090.52	98,00	132
05.075.12	31,00	75	05.086.11	26,00	134	05.088.131/75	3,60	26	05.090.54	30,90	109
05.075.13	19,00	75	05.086.12	45,00	134	05.088.132	7,00	26	05.090.55	30,90	109
05.075.14	52,00	75	05.086.14	102,00	135	05.088.133.	13,80	26	05.090.56	30,90	109
05.075.15	52,00	75	05.086.15	122,00	135	05.088.134.	37,50	159	05.090.57	30,90	109
05.075.16	1.350,00	74	05.086.16	152,00	135	05.088.135.	258,00	28	05.090.58	30,00	109
05.075.17	422,00	75	05.087.02	178,00	143	05.088.136.	520,00	28	05.090.61	38,00	109
05.075.22	11,00	75	05.087.06	115,00	54	05.088.137.	598,00	30	05.090.62	30,00	129
05.075.23	P.A.R	75	05.087.07	305,00	137	05.088.137/R2	132,00	30	05.090.63	28,50	129
05.075.24	4,60	75	05.087.08	387,00	138	05.088.137/R3	228,00	30	05.090.64	69,00	129
05.075.25	14,00	75	05.087.09	653,00	138	05.088.137/R4	369,00	30	05.090.65	69,00	129
05.075.26	4,60	75	05.087.10	38,50	143	05.088.138	427,00	11	05.090.66	8,00	109
05.075.27	56,00	75	05.087.13	96,00	135	05.088.138.R1	244,00	23	05.090.67	98,00	110
05.075.28	13,50	75	05.087.16	210,00	127	05.088.140	560,00	4	05.090.68	69,00	110
05.075.29	13,50	75	05.088.02	62,00	21	05.088.142	1.250,00	157	05.090.70	58,00	120
05.075.30	152,00	75	05.088.03	34,00	21	05.088.147	156,00	11	05.090.72	119,00	115
05.075.31.R1	P.A.R	75	05.088.06X	694,50	6	05.088.148	320,00	137	05.090.73	16,10	80
05.078.04	47,00	132	05.088.25	39,90	21	05.088.149	153,00	29	05.090.75	9,00	119
05.078.07	79,00	124	05.088.30	110,00	18	05.088.150	475,00	10	05.090.76	34,00	119
05.081.04	18,00	41	05.088.40	179,00	11	05.088.152	1.395,00	24	05.090.77	65,00	110
05.081.05	18,00	41	05.088.47	386,50	7	05.088.152.A1	46,00	26	05.090.78	69,00	110
05.083.00	38,00	54	05.088.48	230,45	7	05.088.152.A2	44,00	26	05.090.79	89,00	110
05.083.01	36,00	54	05.088.55X	308,00	6	05.088.152.A3	48,00	26	05.090.80	89,00	110
05.083.02	26,40	31	05.088.56X	538,45	6	05.088.152.A4	68,00	26	05.090.81	126,00	110
05.083.03	46,00	31	05.088.58	175,00	104	05.088.152.R1	590,00	25	05.090.83	79,00	124
05.083.04	26,00	54	05.088.60	88,00	162	05.088.153	70,00	160	05.090.85	18,00	145
05.083.05	15,50	53	05.088.67	27,90	162	05.089.00	60,00	131	05.090.88	8,00	109
05.083.06	39,80	53	05.088.68	28,70	162	05.090.00	57,00	131	05.090.95	461,50	7
05.084.02L	158,00	36	05.088.69	17,90	31	05.090.01	63,00	131	05.090.96	305,45	7
05.084.04	84,00	52	05.088.70	21,90	31	05.090.02	66,00	131	05.090.97	42,00	159
05.084.05P	199,00	35	05.088.73	290,00	29	05.090.05	89,00	131	05.090.98	22,00	163
05.084.07	128,00	37	05.088.74	396,00	29	05.090.07	48,00	121	05.090.99	480,00	19
05.084.11L	850,00	104	05.088.79	39,90	21	05.090.08	48,00	123	05.090.100	520,00	17
05.084.12	22,00	37	05.088.79.R1	13,80	21	05.090.10	108,00	56	05.090.102	59,00	111
05.084.13	30,00	37	05.088.82X	285,00	6	05.090.13	49,00	56	05.090.103	235,00	12
05.084.14	41,40	37	05.088.84X	515,45	6	05.090.14	27,00	133	05.090.104	38,00	132
05.084.15	92,00	37	05.088.85X	671,50	6	05.090.15	57,00	133	05.091.04DP	148,00	108
05.084.16	54,00	37	05.088.87X	590,45	6	05.090.16	76,00	130	05.091.04DPR1	30,00	108
05.084.17	185,00	37	05.088.89X	613,45	6	05.090.17	28,00	130	05.091.05DP	171,00	108
05.084.21	65,00	165	05.088.94W	39,90	103	05.090.22	11,00	144	05.091.05DPR1	30,00	108
05.084.25	94,00	35	05.088.99X	769,50	6	05.090.23	16,50	132	05.091.11	135,00	107
05.084.26	236,00	36	05.088.100X	746,50	6	05.090.24	15,00	109	05.091.12CX	295,00	106
05.084.28	585,00	32	05.088.105.	298,00	20	05.090.25	31,50	145	05.091.12CX.R1	48,00	106
05.084.35	504,00	32	05.088.105N	298,00	20	05.090.26	43,00	133	05.091.13	110,00	106
05.084.37	350,00	32	05.088.109.	198,00	21	05.090.29B	75,00	9	05.091.14	82,00	107
05.084.38	360,00	32	05.088.109W	128,00	21	05.090.30	39,00	8	05.092.01	16,80	146
05.085.00	44,00	37	05.088.112.	9,90	18	05.090.31	43,00	8	05.096.03	10,90	161
05.085.01	28,00	37	05.088.113.	9,90	18	05.090.32	45,50	9	05.096.04	4,50	161
05.085.04C	451,00	127	05.088.114.	268,00	96	05.090.33	39,85	8	05.098.01	34,00	111
05.085.04L	570,00	127	05.088.115.	72,00	96	05.090.34	28,50	8	05.098.02	49,00	122
05.085.05	148,00	128	05.088.116.	370,00	96	05.090.35	25,00	9	05.100.00	11,00	44
05.085.07	62,00	129	05.088.117.	80,00	96	05.090.36	18,50	8	05.100.01	11,00	44
05.085.08COMBI	260,00	52	05.088.125.	27,95	160	05.090.37	13,80	8			

Cod. 05.088.140 € 560,00

7-DRAWER ROLL CAB with 196 tools* (5 full drawers)
with stainless steel top and side door with key

CARRELLO 7 CASSETTI con 196 utensili* (5 cassetti pieni)
con piano inox e sportello laterale con chiave

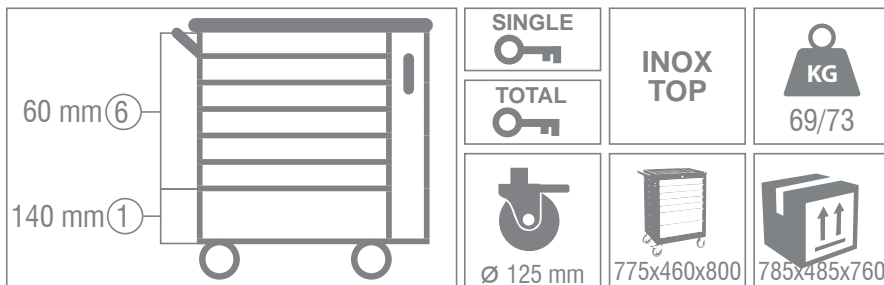

SINGLE LOCKING
FOR EACH DRAWER

STAINLESS STEEL TOP

PERFORATED TOOL HOLDER PANEL
WITH KEY



CHROME
VANADIUM

1



2

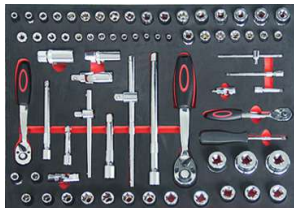

3



4



5



Tutte le immagini dei prodotti pubblicate in questo catalogo sono puramente indicative e possono essere cambiate senza preavviso.
All product images published in this catalogue have explanatory purposes and can be changed with no warning.

1



- 7PCS Screwdriver set, (-): SL6*38 SL8*175 SL3*75
- SL6.0*150 SL3.5*75 SL5*100 SL4*100
- 7PCS Screwdriver set, (+): PH0*75 PH1*100 PH2*100 PH2*125
- PH3*150 PH2*38 PH4*200
- 6PCS screwdriver
- PH1*100, PH2*100, SL3*75, SL4*100, SL5.5*125, SL6.5*150
- 7pcs precision screwdriver PH0, PH00, PH1, SL3.0, SL2.5, SL2.0, SL1.5
- 8pcs hex key



2

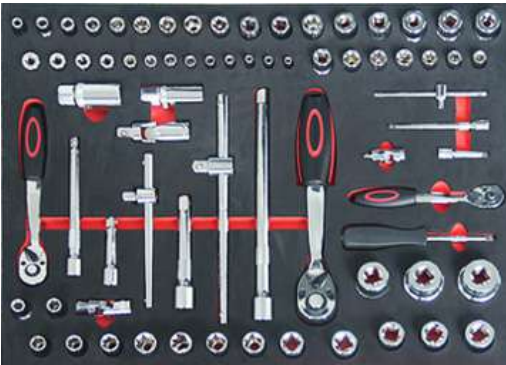

- 17pcs 1/2" DR 10-11-12-13-14-15-16-17-18-19-21-22-23-24-27-30-32 mm
- 1pc 1/2 universal joint
- 1pc 1/2 sliding bar
- 2pc 1/2 extension bar
- 1pc 1/2 ratchet handle 72T
- 17pcs-3/8" dr. Socket: 6-7-8-9-10-11-12-13-14-15-16-17-18-19-20-21-22 mm
- 1pcs 3/8" dr. universal joint
- 1pcs 3/8" dr. Sliding t bar
- 1pcs 3/8" dr x 3" extension bar
- 1pcs 3/8" dr x 6" extension bar
- 2pcs- 3/8" dr. Spark plug socket 16 21mm
- 7pcs-3/8" dr. Tx sockets: E8, E10, E12, E14, E16, E18, E20,
- 1pcs-3/8" ratchet handle
- 13pcs 1/4 dr socket 4-4.5-5-5.5-6-7-8-9-10-11-12-13-14 mm
- 1pc 1/4 universal joint
- 1pc 1/4 sliding bar
- 2pc 1/4 extension bar
- 1pc 1/4 ratchet handle 72T
- 1pc 1/4 sockets holder

3

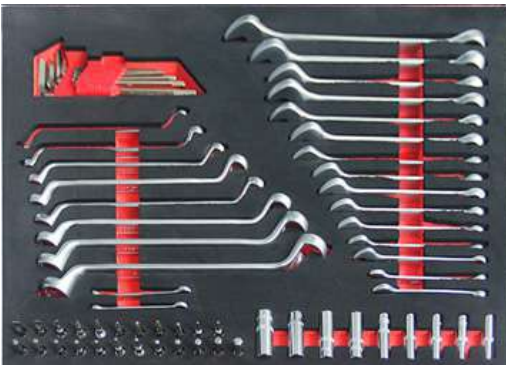

- 9pcs 1/4 deep sockets: 5-6-7-8-9-10-11-12-13 mm
- 23pcs 1/4 socket bits: T8-10-15-20-25-27-30-40, PH1-2-3, PZ1-2-3, SL4-5.5-7, H3-4-5-6-7-8 mm
- 9pcs ball point hex key set: 1.5 mm, 2 mm, 2.5mm, 3mm, 4mm, 5mm, 6mm, 8mm, 10mm
- 8pcs Double Ring Wrench Set: 5,5X7 / 8X10 / 9X11 / 10X12 / 12X14 / 14X17 / 17X19 / 19X22 mm
- 17pcs Combination Wrench set 6-7-8-9-10-11-12-13-14-15-16-17-18-19-20-21-22 mm

4



- 1pc 10" locking plier
- 1pc 10" D4 groove joint plier
- 8" long nose plier
- 7" diagonal plier
- 8" combination plier
- 6pcs Hex Key Wrench Set
- 2.0*100mm, 2.5*100mm, 3.0*100mm
- 4.0*150mm, 5.0*150mm, 6.0*150mm

5



- 1pc 5m measuring tape
- 1pc 1m folding ruler
- 1pc 9" level
- 1pc mini hack saw
- 1pc angle square
- 1pc 300g machinist's hammer
- 1pc 35mm rubber mallet
- Steel Files 1pc flat, 1pc half round, 1pc triangle, 1pc round, 1pc square (T8/T12)

Tutte le immagini dei prodotti pubblicate in questo catalogo sono puramente indicative e possono essere cambiate senza preavviso.
All product images published in this catalogue have explanatory purposes and can be changed with no warning.

CARRELLO 7 CASSETTI • 7-DRAWERS ROLL CAB • CARRITO DE 7 CAJÓNES

Prezzi netti per quantità / Net prices for min. q.ty



VUOTO / EMPTY / VACIO ■ Cod. 05.088.55X € 308,⁰⁰

+ BASIC kit 3 ■ Cod. 05.088.56X € 538,⁴⁵

+ BASIC kit 4 ■ Cod. 05.088.89X € 613,⁴⁵

+ PROFI kit 5 ■ Cod. 05.088.06X € 694,⁵⁰

+ PROFI kit 6 ■ Cod. 05.088.99X € 769,⁵⁰

7		SINGLE KEY	ABS TOP	 KG 76,2
		TOTAL KEY	ANTI-SHOCK PROTECTION	
			770x465x980	790x470x850

CARRELLO 6 CASSETTI • 6-DRAWERS ROLL CAB • CARRITO DE 6 CAJÓNES

Prezzi netti per quantità / Net prices for min. q.ty



VUOTO / EMPTY / VACIO ■ Cod. 05.088.82X € 285,⁰⁰

+ BASIC kit 3 ■ Cod. 05.088.84X € 515,⁴⁵

+ BASIC kit 4 ■ Cod. 05.088.87X € 590,⁴⁵

+ PROFI kit 5 ■ Cod. 05.088.85X € 671,⁵⁰

+ PROFI kit 6 ■ Cod. 05.088.100X € 746,⁵⁰

6		SINGLE KEY	ABS TOP	 KG 58,5
		TOTAL KEY	ANTI-SHOCK PROTECTION	
			780x460x900	780x460x820

Tutte le immagini dei prodotti pubblicate in questo catalogo sono puramente indicative e possono essere cambiate senza preavviso.
All product images published in this catalogue have explanatory purposes and can be changed with no warning.

Cod. 05.088.48 € 230,45

BASIC
kit 3

154 pz / pcs

CHROME
VANADIUM



Cod. 05.090.96 € 305,45

BASIC
kit 4

161 pz / pcs

CHROME
VANADIUM

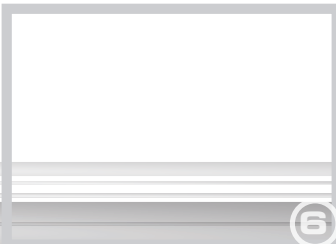
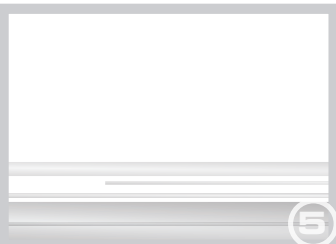

Cod. 05.088.47 € 386,50

PROFI
kit 5

193 pz / pcs

CHROME
VANADIUM

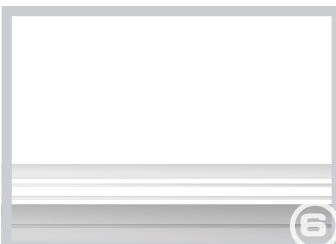
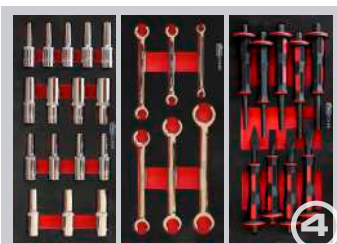

Cod. 05.090.95 € 461,50

PROFI
kit 6

200 pz / pcs

CHROME
VANADIUM



Tutte le immagini dei prodotti pubblicate in questo catalogo sono puramente indicative e possono essere cambiate senza preavviso.
All product images published in this catalogue have explanatory purposes and can be changed with no warning.

Prezzi promozionali / IVA e trasporto non incluso • Promotional prices • Precios promocionales

PROMO 2024

KIT UTENSILI DA ESPOSIZIONE IN MORBIDA SPUGNA BICOLORE
TOOLS EXHIBITION KITS IN SOFT TWO-COLOURED SPONGE
KIT DE EXPOSICIÓN DE HERRAMIENTAS EN ESPONJA BLANDA DE DOS COLORES

CHROME
VANADIUM

FINITURA
LUCIDA
POLISHED

PROMO 2024

	<p>Cod. 05.090.30 € 39,⁰⁰</p> <p>Set 54 bussole/accessori Kit of 54pcs socket wrenches 1/4" Juego de 54pcs llaves de tubo/accesorios 1/4" Materiale • Material: CR-V Il set contiene • The kit includes • El kit incluye: Bussole • socket wrenches • Llaves de tubo 1/4" 4-4,5-5-6-7-8-9-10-11-12-13 mm Bussole lunghe • Long socket wrenches • Llaves largas 1/4" 4-5-6-7-8-9-10-11-12-13-14 mm Bussole • socket wrenches • Llaves torx 1/4" torx E 4-5-6-7-8 Barre estensione • Extension bars • Barras de extension 1/4" 50-75-100 mm Inserti • Inserts • Insertos 1/4" PH1,2 - PZ1,2, SL 4,5 - 5, H3, 4, 5, 6, T8, T10, T15, T20, T25, T30</p>		<p>Cod. 05.090.36 € 18,⁵⁰</p> <p>Set 34 chiavi esagonali a L Kit 34pcs hexagonal L-wrenches Juego de 34pcs llaves hexagonales en L Materiale • Material: CR-V Il set contiene • The kit includes • El kit incluye: 9 chiavi esag. • 9 hexagon keys • 9 llaves hex. 1,5 - 2 - 2,5- 3 - 4 - 5- 6 - 8 - 10mm 9 chiavi esag. SAE • 9 SAE hexagon keys • 9 llaves hex. SAE 1/16, 5/64, 3/32, 1/8, 5/32, 3/16, 1/4, 5/16, 3/8 8 chiavi torx • 8 torx keys • 8 llaves torx T9, T10, T15, T20, T25, T27, T30, T40 8 chiavi esag. SAE • 8 SAE hexagon keys • 8 llaves hex. SAE 1/16, 5/64, 3/32, 1/8, 5/32, 3/16, 7/32, 1/4"</p>
	<p>Cod. 05.090.31 € 43,⁰⁰</p> <p>Set 19 bussole/accessori 1/2" Kit 19pcs socket wrenches/accessories 1/2" Juego de 19pcs llaves de tubo/accesorios 1/2" Materiale • Material: CR-V Il set contiene • The kit includes • El kit incluye: Bussole Socket wrenches Llaves de tubo 1/2" 10 - 11 - 12 -13- 14 - 15 -16 -17- 18 - 19 - 21 - 22- 23 - 24mm Barre estensione • Extension bars • Barras de extension 1/2" 125-150mm Giunto girevole 1/2" • 1/2" Swivel joint • Junta rotatoria 1/2" Barra scorrevole 1/2" • 1/2" Sliding bar • Barra corredera 1/2" 25mm Cricchetto 1/2" • 1/2" Ratchet • Carraca 1/2"</p>		<p>Cod. 05.090.37 € 13,⁸⁰</p> <p>Set 7 cacciaviti torx Kit 7pcs torx screwdrivers Juego de 7pcs destornilladores torx Materiale • Material: CR-V Il set contiene • The kit includes • El kit incluye: T10/75, T15/100, T20/100, T25/100, T30/100, T40/100</p>
	<p>Cod. 05.090.33 € 39,⁸⁵</p> <p>Set 17 chiavi combinate Kit 17pcs combined wrenches Juego de 17pcs llaves combinadas Materiale • Material: CR-V Il set contiene • The kit includes • El kit incluye: 6-7-8-9-10-11-12-13-14-15-16-17-18-19-20-21-22mm</p>		<p>Cod. 05.090.38 € 14,⁰⁰</p> <p>Set 8 cacciaviti a taglio e croce Kit 8pcs screwdrivers with flat and cross tip Juego de 8pcs destornilladores con punta plana y en cruz Materiale • Material: CR-V Il set contiene • The kit includes • El kit incluye: 6,5x1,2x38 4x08x100 5,5x1x100 6,5x1,2x150 2x38, 1x100 2x100, 3x150</p>
	<p>Cod. 05.090.34 € 28,⁵⁰</p> <p>Set 8 chiavi poligonali Kit 8pcs polygonal wrenches Material CR-V Juego de 8pcs llaves poligonales Materiale • Material: CR-V Il set contiene • The kit includes • El kit incluye: 6x7, 8x9, 10x11, 12x13, 14x15, 16x17, 18x19, 20x22mm</p>		<p>Cod. 05.090.42 € 14,⁹⁰</p> <p>2 pinze L = 250mm 2 pliers L = 250mm 2 alicates L = 250mm Materiale • Material: CR-V Il set contiene • The kit includes • El kit incluye: Pinza a coccodrillo • Crocodile clips • Pinza de cocodilo L = 250mm Pinza per lamiera • Plate grip Pinzas • de chapa L = 250mm</p>

Tutte le immagini dei prodotti pubblicate in questo catalogo sono puramente indicative e possono essere cambiate senza preavviso.
All product images published in this catalogue have explanatory purposes and can be changed with no warning.

	Cod. 05.090.41 € 18, ⁹⁰
	<p>Set 3 pinze Kit 3pcs pliers Juego de 3pcs alicates</p> <p>Materiale • Material: CR-V</p> <p>Il set contiene • The kit includes • El kit incluye:</p> <p>Pinza combinata • Combined pliers • Alicates combinados 200mm Pinza a becchi dritti • Straight nose pliers • Alicates de punta fina 200mm Tronchesi • Clippers • Tijeras</p>

	Cod. 05.090.29B € 75, ⁰⁰
	<p>Kit 7 chiavi a T snodate 7 T-bended wrenches kit Juego de llaves de cubo a T</p> <p>Materiale • Material: CR-V</p> <p>Il set contiene • The kit includes • El kit incluye:</p> <p>7, 8, 10, 11, 13, 15, 17 mm</p>

	Cod. 05.090.32 € 45, ⁵⁰
	<p>Kit 16pcs bussole lunghe 1/2" Materiale CR-V Kit 16pcs long socket wrenches 1/2" Material CR-V Juego de 16pcs llaves de tubo largas 1/2"</p> <p>Materiale • Material: CR-V</p> <p>Il set contiene • The kit includes • El kit incluye:</p> <p>Chiavi esagonali • Hexagonal wrenches • Llaves hexagonales 1/2" 8-9-10-11-12-13mm Chiavi torx • Torx wrenches • Llaves torx 1/2" E10, E11, E12, E14, E16, E18, E20, E22, E24</p>

	Cod. 05.090.43 € 19, ⁵⁵
	<p>Kit 4pcs pinze seeger Kit 4pcs pliers for seeger Juego de 4pcs alicates para seeger</p> <p>Materiale • Material: CR-V</p> <p>Il set contiene • The kit includes • El kit incluye:</p> <p>Dritta per seeger interni • straight for internal seegers • recta para seeger internos Angolare per seeger interni • bent for internal seegers • curvada para seeger internos Dritta per seeger esterni • straight for external seegers • recta para seeger externos Angolare per seeger esterni • bent for external seegers • curvada para seeger externos</p>

	Cod. 05.090.35 € 25, ⁰⁰
	<p>Set 6pcs chiavi per tubi freni Kit 6pcs wrenches for brake hoses Juego de 6pcs de llaves para mangueras de frenos</p> <p>Materiale • Material: CR-V</p> <p>Il set contiene • The kit includes • El kit incluye:</p> <p>6*8 - 10*12 - 13*14 - 15*17 - 19*21 - 22*24mm</p>

	Cod. 05.090.44 € 16, ⁵⁰
	<p>2pcs martelli 2pcs hammers 2pcs martillos</p> <p>Il set contiene • The kit includes • El kit incluye:</p> <p>1pz martello • 1pc hammer • 1pc martillo 300gr 1pz mazzuolo in plastica • 1pc plastic maller • 1pc mazo de plastico</p>

	Cod. 05.090.39 € 29, ⁵⁰
	<p>Kit 9pcs scalpelli Kit 9pcs chisels Juego de 9pcs cinceles</p> <p>Il set contiene • The kit includes • El kit incluye:</p> <p>3pz punta piatta • 3pcs flat head • 3pcs punta plana 19x12x180; 12x10x160; 16x12x175 2pz punta fine • 2pcs pin head • 2pcs punta fina 8x12x180; 10x12x180 2pz punta conica • 2pcs taper punch • 2pcs punta conica 6x10x180; 8x12x180 1pz punta triangolare • 1pc triangular head • 1pc punta triangular 6x10x180</p>

	Cod. 05.090.40 € 20, ⁰⁰
	<p>Kit 5pcs lime 8" Kit 5pcs files 8" Juego de 5pcs limas 8"</p> <p>Il set contiene • The kit includes • El kit incluye:</p> <p>1 lima piana • 1 flat file • 1 lima fina 1 lima mezza tonda • 1 half rounded file • 1 lima media redondeada 1 lima triangolare • 1 triangular file • 1 lima triangular 1 lima quadra • 1 square file • 1 lima cuadrada 1 lima tonda • 1 rounded file • 1 lima redondeada</p>



BUDGET

Cod. 05.088.150 € 475,00

CARRELLO 7 CASSETTI con 172 utensili (4 cassetti pieni) su supporto di morbida spugna

7-DRAWER ROLL CAB with 172 tools (4 full drawers) on soft sponge support

CARRITO DE 7 CAJÓNES con 172 herramientas (4 cajones llenos) en soporte de esponja blanda

CHROME VANADIUM

	SINGLE 	ABS TOP 	KG 76,2
	TOTAL 	ANTI-SHOCK PROTECTION 	770x460x908
		780x480x1020 	



SET DI BUSSOLE, 108 PZ

108 PCS SOCKET SET TOOL TRAY

- 1x chiave a cricchetto universale/universal ratchet handle 1/2"
- 1x adattatore/ head adapter 1/2"*5/16"
- 5 bussole profonde/deep sockets 1/2" (6PT): 14, 15, 17, 19 e 22 mm
- 17 bussole metriche/metric sockets 1/2" (6PT): 10, 11, 12, 13, 14, 15, 16, 17, 18, 19, 20, 21, 22, 24, 27, 30 e 32 mm
- 8 bussole a stella/star sockets 1/2": E10, E11, E12, E14, E16, E18, E20 e E24
- 2 bussole per candele/spark plug sockets 1/2": 16 mm e 21 mm
- 2x barre di prolunga/extension bars: 5" e 10" con testa scorrevole
- 1 giunto cardanico/universal joint 1/2"
- 1x impugnatura a cricchetto universale/universal

ratchet handle 1/4"

- 18 bussole punte/bit sockets: PH: #1, #2 / PZ: #1 e #2 / HEX: 3, 4, 5, 6 mm / SL: 4, 5, 5, 6, 5 mm / TX: 8, 10, 15, 20, 25, 27, 30 mm
- 1 maniglia rotante/spin handle 1/4"
- 1 giunto cardanico/universal joint 1/4"
- 1 maniglia scorrevole/slide handle 1/4"
- 2x barre di estensione/extension bars: 2", 5"
- 13 bussole metriche/metric sockets (6PT): 4, 4, 5, 5, 5, 6, 7, 8, 9, 10, 11, 12, 13, 14 mm
- 8 prese profonde/deep sockets 1/4" (6PT): 6, 7, 8, 9, 10, 11, 12 e 13 mm
- 5 prese a stella/star sockets 1/4": E4, E5, E6, E7 ed E8
- 17 punte/bits (8 mm): HEX: 7, 8, 10, 12, 14 mm / SL: 8, 10, 12 mm / PH: #3, #4 / PZ: #3, #4 / TX: 40, 45, 50, 55, 60 mm
- 3 chiavi a brugola/allen keys: 1,5, 2, 2,5 mm



SET DI CACCIAVITE E CHIAVI A "L", 30 PZ

- Cacciavite a croce - 2x38 mm / PH 0x75 mm PH 1 x 100 mm / PH 2 x 100 mm / PH 3 x 150 mm / PH 4 x 200 mm
- Cacciavite a taglio - SL 6x38 mm / SL 3x100 mm / SL 5x75 mm / SL 6x100 mm / SL 8x150 mm / SL 10x200 mm
- Set di 9 chiavi a brugola a "L" con estremità tonda
- Set di 9 chiavi torx a "L"

30 PCS SCREWDRIVER AND "L" KEY SET TRAY

- Phillips screwdriver - 2x38 mm / PH 0x75 mm PH 1 x 100 mm / PH 2 x 100 mm / PH 3 x 150 mm / PH 4 x 200 mm
- Slotted screwdriver - SL 6x38 mm / SL 3x100 mm / SL 5x75 mm / SL 6x100 mm / SL 8x150 mm / SL 10x200 mm
- Set of 9 allen keys "L" shaped with round end
- Set of 9 torx keys "L" shaped



SET DI CHIAVI, 25 PZ

- Chiave doppia ad anello: 6x7mm, 8x9mm, 10x11mm, 12x13mm, 14x15mm, 16x17mm, 18x19mm, 20x22mm
- Chiave combinata: 6-7-8-9-10-11-12-13-14-15-16-17-18-19-20-21-22 mm

25 PIECE SPANNER SET TRAY

- Double end ring spanner: 6x7mm, 8x9mm, 10x11mm, 12x13mm, 14x15mm, 16x17mm, 18x19mm, 20x22mm
- Combination spanner: 6-7-8-9-10-11-12-13-14-15-16-17-18-19-20-21-22mm



SET MARTELLI E PINZE, 9 PZ

- Martello a penna sferica
- Mazzuola antirimbazzo
- Pinza per pompa acqua 10"
- Pinze per anelli elastici interni da 7" (punte dritte)
- Pinze per anelli elastici esterni 7" (punte dritte)
- Pinza di bloccaggio 10"
- Pinza diagonale 7,5"
- Pinza a becco lungo 8"
- Metro a nastro, 3m

9 PCS HAMMER AND PLIER SET TRAY

- Ball pein hammer
- Install hammer
- Water pump plier 10"
- 7" internal circlip pliers (straight tips)
- 7" external circlip pliers (straight tips)
- Locking plier 10"
- Diagonal plier 7.5"
- Long nose plier 8"
- Measuring tape 3m

Tutte le immagini dei prodotti pubblicate in questo catalogo sono puramente indicative e possono essere cambiate senza preavviso.
All product images published in this catalogue have explanatory purposes and can be changed with no warning.



Cod. 05.088.138 € **427,00**

CARRELLO 6 CASSETTI con 172 utensili/4 cassette pieni su supporto di morbida spugna

6-DRAWER ROLL CAB with 172 tools/4 full drawers on soft sponge support

CARRITO DE 6 CAJONES con 172 herramientas/4 cajones llenos en soporte de esponja blanda



CHROME VANADIUM

Vedi pg. 25 per dettagli e misure
See pag. 25 for details and measurements
Ver pág. 25 para detalles y medidas

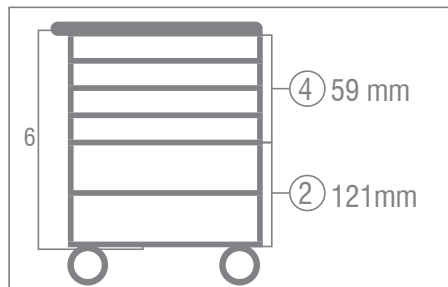

TOTAL 	RUBBER TOP	KG 60
	 600x400x783	 660x460x720



Cod. 05.088.40 € **179,00**



CARRELLO 5 CASSETTI • **5-DRAWERS ROLL CAB** • **CARRO 5 CAJONES VUOTO** • **EMPTY** • **VACÍO**

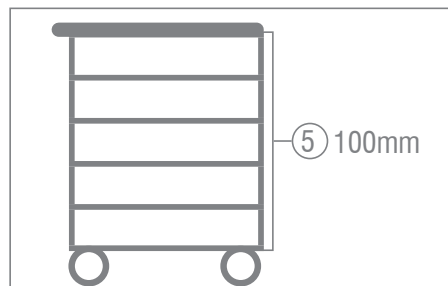

RUBBER TOP		
TOTAL 		
 615x330x762	 680x385x730	KG 27,2

GUIDA SU CUSCINETTI
BALL BEARING SLIDES
GUIA CON COJINETES DE BOLAS

Cod. 05.088.147 € **156,00**

4 VASSOI PORTAUTENSILI EVA PER 05.088.40 (107 UTENSILI)

4 EVA TOOL TRAYS FOR 05.088.40 (107 TOOLS)

4 PORTAHERRAMIENTAS EVA PARA 05.088.40 (107 HERRAMIENTAS)

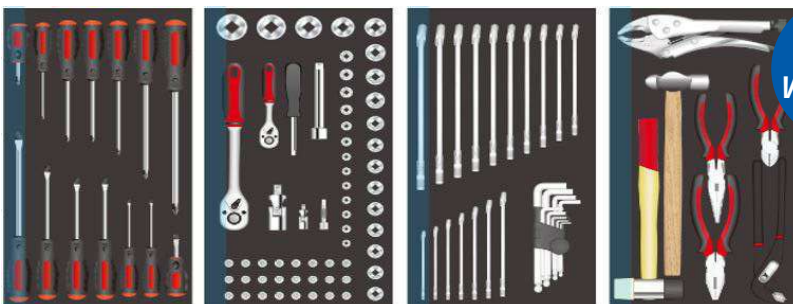

CHROME VANADIUM

Vedi pg. 27 per dettagli e misure
See pag. 27 for details and measurements
Ver pág. 27 para detalles y medidas

Cod. 05.090.103

€ 235,00

CASSETTIERA PORTAUTENSILI UNIVERSALE

con 300 utensili inclusi

TOOL CHEST OF DRAWERS

with 300 tools included



NEW!
2024

1 cricchetto reversibile, dentatura fine 6.3 mm (1/4")
1 bussola porta inserti con sfera di tenuta, quadro interno 6.3 mm (1/4"), esagono interno 6.3 mm (1/4")
1 snodo con molla 6.3 mm (1/4")
5 bussole profilo a E 6.3 mm (1/4"): E4, E5, E6, E7, E8
4 inserti, attacco esagono esterno 6.3 mm (1/4"), intaglio a croce: PH1, PH2, PZ1, PZ2
10 inserto, attacco esagono esterno 6.3 mm (1/4"), profilo a T (per Torx): T5, T6, T7, T10, T15, T20, T25, T27, T30, T40
1 inserto, attacco esagono esterno 6.3 mm (1/4") profilo a T (per Torx) con foro: T7
6 inserti, lunghezza 25 mm, attacco esagono esterno 6.3 mm (1/4") profilo a T (per Torx) con foro: T10, T15, T20, T25, T27, T30
10 inserti, attacco esagono esterno 6.3 mm (1/4"), T-Star tamperproof (per Torx): T40, TS10, TS15, TS20, TS25, TS27, TS30, TS40, TS45
5 inserti, attacco esagono esterno 6.3 mm (1/4") profilo a cuneo (per RIBE): M5, M6, M7, M8, M9
3 inserti, attacco esagono esterno 6.3 mm (1/4") drive, spline for XZN: M5, M6, M8
2 inserti, attacco esterno 6.3 mm (1/4"), esagono interno: 2 mm, 2.5 mm
14 chiavi combinate: 1/4", 5/16", 11/32", 3/8", 7/16", 1/2", 9/16", 5/8", 11/16", 3/4", 6 mm, 7 mm, 8 mm, 9 mm, 10 mm, 11 mm, 12 mm, 13 mm, 14 mm, 15 mm, 16 mm, 17 mm, 18 mm, 19 mm
4 chiavi a bussola, 6.3 mm (1/4"), taglio SL: 4 mm, 5.5 mm, 6.5 mm, 7 mm
6 chiavi a bussola, 6.3 mm (1/4") intaglio a croce: PH0, PH1, PH2, PZ0, PZ1, PZ2
4 chiavi a bussola, 6.3 mm (1/4"), esagono interno: 3 mm, 4 mm, 5 mm, 6 mm
8 chiavi a bussola, 6.3 mm (1/4"), profilo a T (per Torx) con foro T8, T9, T10, T15, T20, T25, T27, T30
8 chiavi a bussola, 6.3 mm (1/4"), profilo a T (per Torx) tamperproof (per Torx) T8, T9, T10, T15, T20, T25, T27, T30
3 inserti, 8 mm (5/16"), taglio SL: 8 mm 10 mm 12 mm
4 chiavi a bussola, 8 mm (5/16"), intaglio a croce: PH3, PH4, PZ3, PZ4
1 chiave a bussola, 8 mm (5/16"), esagono interno: 7 mm

28 inserti per bussole esagonali 12.5 mm (1/2") 7/16", 1/2", 9/16", 5/8", 11/16", 3/4", 13/16", 7/8", 15/16", 1", 1.1/16", 1.1/8", 1.3/16", 1.1/4", 15 mm, 16 mm, 17 mm, 18 mm, 19 mm, 20 mm, 21 mm, 22 mm, 24 mm, 26 mm, 27 mm, 28 m, 30 m, 32 mm
1 inserto esagonale per candele di accensione 12.5 mm (1/2"): 16 mm
1 inserto esagonale per candele di accensione 12.5 mm (1/2"): 21 mm
1 cricchetto reversibile, dentatura fine 12.5 mm (1/2")
1 bussola porta inserti con sfera di tenuta, esagono interno 12.5 mm (1/2") esagono interno 8 mm (5/16")
1 snodo con molla 12.5 mm (1/2")
1 prolunga 12.5 mm (1/2"): 75 mm
1 prolunga con testa sferica 12.5 mm (1/2"): 125 mm
1 bussola profilo a E 12.5 mm (1/2") drive: E20
1 bussola profilo a E 12.5 mm (1/2") drive: E24
22 inserti per bussole esagonali 10 mm (3/8"): 1/4", 5/16", 3/8", 7/16", 1/2", 9/16", 5/8", 11/16", 3/4", 13/16", 7/8", 6 mm, 7 mm, 8 mm, 9 mm, 10 mm, 11 mm, 12 mm, 13 mm, 14 mm, 15 mm, 16 mm, 17 mm, 18 mm, 19 mm, 20 mm, 21 mm, 22 mm
18 inserti per bussola, profondo 10 mm (3/8"): 3/8", 7/16", 1/2", 9/16", 5/8", 11/16", 3/4", 8 mm, 10 mm, 11 mm, 12 mm, 13 mm, 14 mm, 15 mm, 16 mm, 17 mm, 18 mm, 19 mm
1 cricchetto reversibil, dentatura fine 10 mm (3/8")
1 bussola porta inserti con sfera di tenuta, quadro interno 10 mm (3/8"), esagono interno 8 mm (5/16")
1 snodo con molla 10 mm (3/8")
2 prolunghe con testa sferica 10 mm (3/8"): 75 mm, 150 mm
6 bussole profilo a E 10 mm (3/8"): E10, E11, E12, E14, E16, E18
23 inserti per bussole esagonali 6.3 mm (1/4"): 5/32", 3/16", 7/32", 1/4", 9/32", 5/16", 11/32", 3/8", 7/16", 1/2", 9/16", 4 mm, 5 mm, 5.5 mm, 6 mm, 7 mm, 8 mm, 9 mm, 10 mm, 11 mm, 12 mm, 13 mm, 14 mm
21pcs of sockets, hexagon, deep 6.3 mm (1/4") drive: 3/16", 7/32", 1/4", 9/32", 5/16", 11/32", 3/8", 7/16", 1/2", 9/16", 4 mm, 5 mm, 6 mm, 7 mm, 8 mm, 9 mm, 10 mm, 11 mm, 12 mm, 13 mm, 14 mm
1 impugnatura portainseriti, esagono interno 6.3 mm (1/4"): 200 mm
3 prolunghe con testa sferica 6.3 mm (1/4"): 50 mm, 100 mm, 150 mm

Tutte le immagini dei prodotti pubblicate in questo catalogo sono puramente indicative e possono essere cambiate senza preavviso.
All product images published in this catalogue have explanatory purposes and can be changed with no warning.

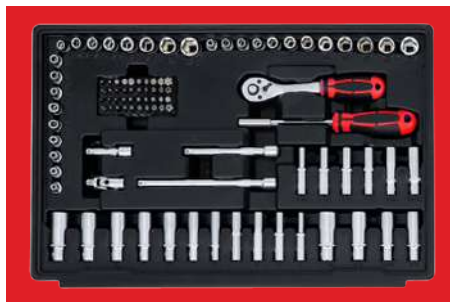

1 universal joint 6.3 mm (1/4")

5 of sockets, E-type, 6.3 mm (1/4") drive: E4, E5, E6, E7, E8

4 of bit sockets 6.3 mm (1/4") drive, **cross slot**: PH1, PH2, PZ1, PZ2

10 of bit sockets 6.3 mm (1/4") drive, **T-Star (for Torx)**: T5, T6, T7, T10, T15, T20, T25, T27, T30, T40

1 bit socket, 6.3 mm (1/4") drive, **T-Star tamperproof (for Torx)**: T7

6 of bit sockets, length 25 mm, 6.3 mm (1/4") drive, **T-Star tamperproof (for Torx)**: T10, T15, T20, T25, T27, T30

1 bit socket, 6.3 mm (1/4") drive, **T-Star tamperproof (for Torx)**: T40, TS10, TS15, TS20, TS25, TS27, TS30, TS40, TS45

5 of bit sockets 6.3 mm (1/4") drive, spline for RIBE: M5, M6, M7, M8, M9

3 of bit sockets 6.3 mm (1/4") drive, spline for XZN: M5, M6, M8

2 of bit sockets 6.3 mm (1/4") drive, internal hexagon: 2 mm, 2.5 mm

14 of combination spanners: 1/4", 5/16", 11/32", 3/8", 7/16", 1/2", 9/16", 5/8", 11/16", 3/4", 6 mm, 7 mm, 8 mm, 9 mm, 10 mm, 11 mm, 12 mm, 13 mm, 14 mm, 15 mm, 16 mm, 17 mm, 18 mm, 19 mm

4 of bit sockets, 6.3 mm (1/4") drive, slot SL: 4 mm, 5.5 mm, 6.5 mm, 7 mm

6 of bit sockets, 6.3 mm (1/4") drive, cross slot: PH0, PH1, PH2, PZ0, PZ1, PZ2

4 of bit sockets, 6.3 mm (1/4") drive, internal hexagon: 3 mm, 4 mm, 5 mm, 6 mm

8 of bit sockets, 6.3 mm (1/4") drive, T-Star (for Torx) T8, T9, T10, T15, T20, T25, T27, T30

8 of bit sockets, 6.3 mm (1/4") drive, T-Star tamperproof (for Torx) T8, T9, T10, T15, T20, T25, T27, T30

3 of bit sockets, 8 mm (5/16") drive, slot SL: 8 mm 10 mm 12 mm

4 of bit sockets, 8 mm (5/16") drive, cross slot: PH3, PH4, PZ3, PZ4

1 of bit socket, 8 mm (5/16") drive, internal hexagon: 7 mm

28 of sockets, hexagon 12.5 mm (1/2") drive
7/16", 1/2", 9/16", 5/8", 11/16", 3/4", 13/16", 7/8", 15/16", 1", 1.1/16", 1.1/8", 1.3/16", 1.1/4", 15 mm, 16 mm, 17 mm, 18 mm, 19 mm, 20 mm, 21 mm, 22 mm, 24 mm, 26 mm, 27 mm, 28 mm, 30 mm, 32 mm

1 spark plug socket, hexagon 12.5 mm (1/2") drive: 16 mm

1 spark plug socket, hexagon 12.5 mm (1/2") drive: 21 mm

1 reversible ratchet fine tooth 12.5 mm (1/2")

1 bit adaptor with retaining ball 12.5 mm (1/2") drive, internal hexagon 8 mm (5/16")

1 universal joint 12.5 mm (1/2")

1 extension bar 12.5 mm (1/2"): 75 mm

1 "wobble" extension bar 12.5 mm (1/2"): 125 mm

2 sockets, E-type 12.5 mm (1/2") drive: E20, E24

22 of sockets, hexagon 10 mm (3/8"), drive: 1/4", 5/16", 3/8", 7/16", 1/2", 9/16", 5/8", 11/16", 3/4", 13/16", 7/8", 6 mm, 7 mm, 8 mm, 9 mm, 10 mm, 11 mm, 12 mm, 13 mm, 14 mm, 15 mm, 16 mm, 17 mm, 18 mm, 19 mm, 20 mm, 21 mm, 22 mm

18 of sockets, hexagon, deep 10 mm (3/8") drive: 3/8", 7/16", 1/2", 9/16", 5/8", 11/16", 3/4", 8 mm, 10 mm, 11 mm, 12 mm, 13 mm, 14 mm, 15 mm, 16 mm, 17 mm, 18 mm, 19 mm

1 reversible ratchet, fine tooth 10 mm (3/8")

1 bit adaptor with retaining ball 10 mm (3/8") drive, internal hexagon 8 mm (5/16")

1 universal joint 10 mm (3/8")

2 of "wobble" extension bars 10 mm (3/8"): 75 mm, 150 mm

6 of sockets, E-type 10 mm (3/8") drive: E10, E11, E12, E14, E16, E18

23 of sockets, hexagon 6.3 mm (1/4") drive: 5/32", 3/16", 7/32", 1/4", 9/32", 5/16", 11/32", 3/8", 7/16", 1/2", 9/16", 4 mm, 5 mm, 5.5 mm, 6 mm, 7 mm, 8 mm, 9 mm, 10 mm, 11 mm, 12 mm, 13 mm, 14 mm

21 of sockets, hexagon, deep 6.3 mm (1/4") drive: 3/16", 7/32", 1/4", 9/32", 5/16", 11/32", 3/8", 7/16", 1/2", 9/16", 4 mm, 5 mm, 6 mm, 7 mm, 8 mm, 9 mm, 10 mm, 11 mm, 12 mm, 13 mm, 14 mm

1 spinner handle for bits, internal hexagon 6.3 mm (1/4"): 200 mm

3 of "wobble" extension bars 6.3 mm (1/4"): 50 mm, 100 mm, 150 mm

1 reversible ratchet, fine tooth 6.3 mm (1/4")

1 bit adaptor with retaining ball 6.3 mm (1/4") drive, internal hexagon 6.3 mm (1/4")

ACCESSORI SERVIZIO SU VETTURE ELETTRICHE
ACCESSORIES FOR SERVICE ON ELECTRIC VEHICLES
ACCESORIOS PARA EL MANTENIMIENTO EN VEHICULOS ELECTRICOS

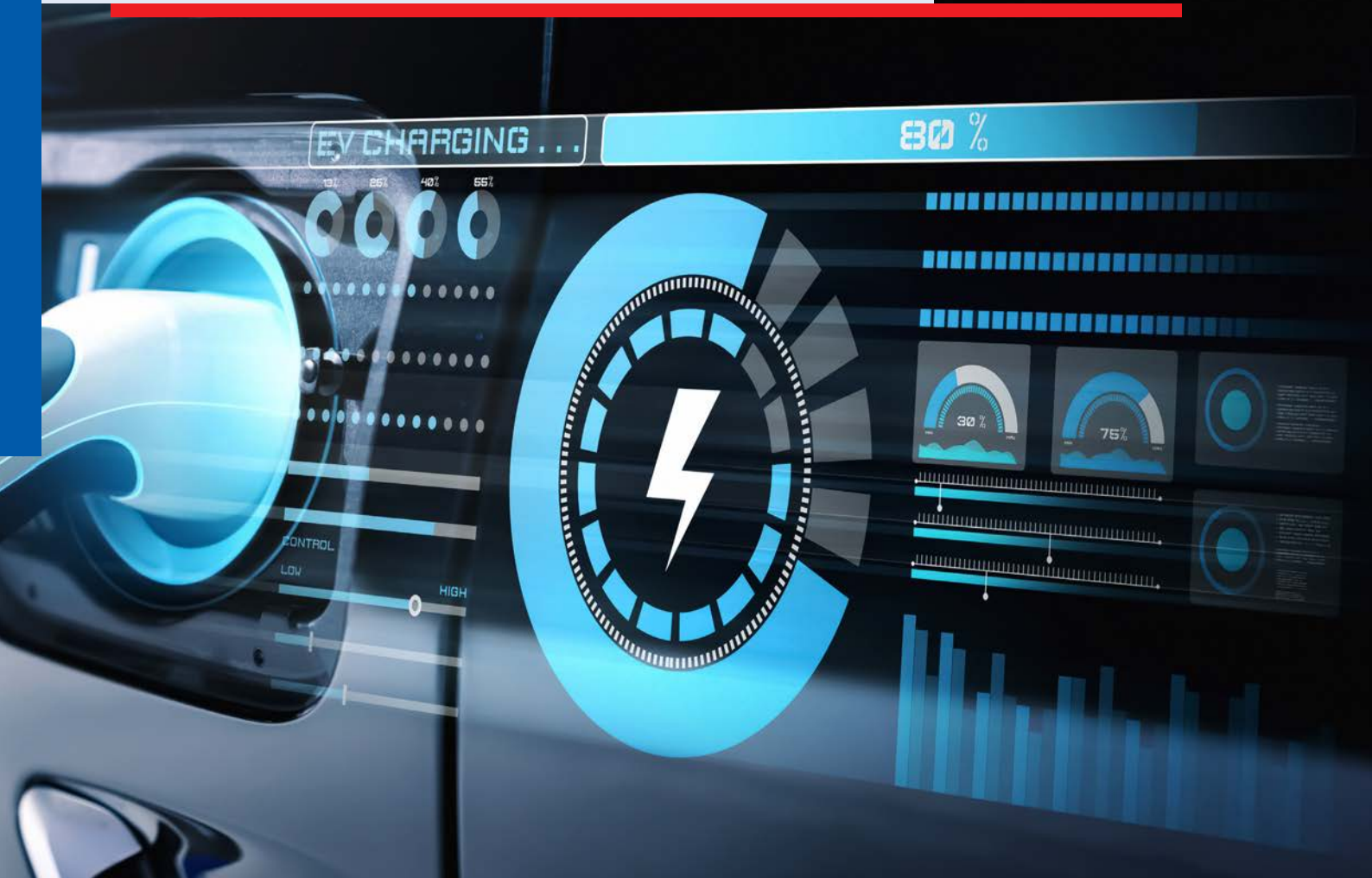

Tutte le immagini dei prodotti pubblicate in questo catalogo sono puramente indicative e possono essere cambiate senza preavviso.
All product images published in this catalogue have explanatory purposes and can be changed with no warning.

ATTREZZI PER LA MESSA IN SICUREZZA POSTAZIONE DI LAVORO SU VETTURE IBRIDE
ACCESSORIES FOR SECURING THE WORK AREA ON HYBRID VEHICLES
ACCESORIOS PARA LA PUESTA EN SEGURIDAD DEL AREA DE TRABAJO EN VEHÍCULOS HÍBRIDOS



Cod. 01.000.337

€ 74,00

MASCHERA FACIALE PER PROTEZIONE ELETTRICA
ELECTRICAL PROTECTION FACE MASK
MÁSCARA FACIAL DE PROTECCIÓN ELÉCTRICA

- Conforme al regolamento UE 2016/425
- Compliant with EU regulation 2016/425
- Cumple con la normativa UE 2016/425



Cod. 01.000.335

€ 64,00

GUANTI ISOLANTI PER PROTEZIONE ELETTRICA
INSULATING GLOVES FOR ELECTRICAL PROTECTION
GUANTES AISLANTES PARA PROTECCIÓN ELÉCTRICA

- Conforme al regolamento UE 2016/425 e alle norme EN60903:2003 Classe 0 Cat III
- Compliant with EU regulation 2016/425 and EN 60903:2003 Class 0 Cat III standards
- Cumple con la normativa UE 2016/425 y las normas EN 60903:2003 Clase 0 Cat III



Cod. 01.000.338

€ 39,90

KIT DELIMITAZIONE PER AREA MANUTENZIONE VEICOLI ELETTRICI
DELIMITATION KIT FOR ELECTRIC VEHICLES' MAINTENANCE AREA
KIT DE DELIMITACIÓN PARA ZONA DE MANTENIMIENTO DE VEHÍCULOS ELÉCTRICOS

- 4 colonne porta catena
- 4 chain-holder columns
- 4 columnas porta cadenas
- Colore giallo-nero, con base riempibile con acqua o sabbia
- Yellow-black colour, with base that can be filled with water or sand
- Color amarillo-negro, con base que se puede rellenar con agua o arena



Cod. 01.000.333

€ 19,95

Catena in plastica L=25mt, Ø6mm per cod. 01.000.332

Plastic chain L=25mt, Ø6mm for cod. 01.000.332

Cadena de plástico L=25mt, Ø6mm para cod. 01.000.332



Cod. 01.000.334

€ 0,65

Set di ganci per catena 01.000.333

Set of hooks for chain 01.000.333

Juego de ganchos para cadena 01.000.333

Cod. 04.005.06

€ 145,00



MULTIMETRO AD ALTO ISOLAMENTO PER VETTURE ELETTRICHE
HIGH INSULATION MULTIMETER FOR ELECTRIC CARS
MULTÍMETRO DE ALTO AISLAMIENTO PARA COCHES ELÉCTRICOS

MULTIMETRO "HYBRID"



- AC Voltage: 6V/60/ 600V/ 750V
- DC Voltage: 600mV/6V/60/600V/1000V
- AC Current with test leads: 60mA/600mA/ 6A/20A
- DC Current with test leads: 60mA/600mA/6A/20A
- Current with optional probes: DC 20A,100A,200A,1500A AC20A,100A,200A 1500A
- Frequency: 9.999Hz-9.999.99MHz
- Temperature: -20 to +1000°C, -4 to +1832°F
- Duty Cycle: 0.5% ~ 95%

- Tensione CA: 6 V/60/ 600 V/ 750 V
- Tensione CC: 600 mV/6 V/60/600 V/1000 V
- Corrente CA con puntali: 60 mA/600 mA/ 6 A/20 A
- Corrente CC con puntali: 60 mA/600 mA/6 A/20 A
- Corrente con sonde opzionali: DC 20A,100A,200A,1500A AC20A,100A,200A 1500A
- Frequenza: 9.999Hz-9.999.99MHz
- Temperatura: da -20 a +1000°C, da -4 a +1832°F
- Ciclo di lavoro: 0,5% ~ 95%
- Ampiezza dell'impulso: 0,5 ms ~ 20 ms
- Angolo di sosta: 4/5/6/8 cilindri
- RPM (velocità di rotazione): Motore a 2 tempi: 60 RPM ~ 20.000 RPM Motore a 4 tempi: 120 RPM ~ 20.000 RPM
- Dimensioni: 190 x 89 x 62 mm
- Peso: 423 g (batteria inclusa)
- Classe di sicurezza: questo strumento è stato progettato secondo la norma IEC 61010 relativa agli strumenti di misura elettronici con categorie di misura 1 CAT III 1000 V e CAT IV 600 V e grado di inquinamento 2

- Pulse Width: 0.5ms ~ 20ms
- Dwell Angle: 4/5/6/8 Cylinders
- RPM (rotation speed): 2-stroke engine: 60 RPM ~ 20000RPM 4-stroke engine: 120 RPM ~ 20000RPM
- Dimensions: 190 x 89 x 62mm
- Weight: 423g (including battery)
- Safety class: This meter has been designed according to IEC 61010 concerning electronic measuring instruments with measurement categories 1 CAT III 1000V and CAT IV 600V and Pollution Degree 2

Cod. 01.000.336

€ 76,00



TAPPETO ALTO ISOLAMENTO (A METRAGGIO)
INSULATED FLOOR MAT

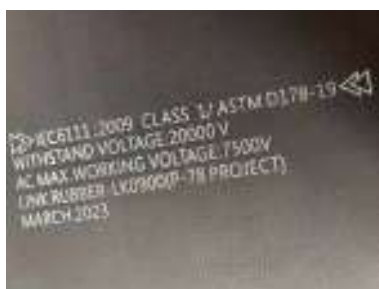

- Dimensioni: 1 x 0,6 m
- Spessore: 4 mm
- Materiale: miscela di butadiene benzene naturale
- Peso: 4-4,2 kg
- CEI 61111:2009 CLASSE 1
- Resistenza alla tensione: 20000 V
- Tensione max AC: 7500 V

- Size: 1m x 0.6m
- Thickness: 4mm
- Material: Natural butadiene benzene mixture
- Weight:4-4.2kg
- IEC 61111:2009 CLASS 1
- Withstand voltage: 20000V
- AC Max working voltage: 7500V

Cod. 01.000.339

€ 82,00



PALO DI SOCCORSO ANTISHOCK
INSULATED RESCUE HOOK



Lunghezza / Length: 150cm



Il palo di soccorso antishock viene utilizzato per rimuovere da una posizione pericolosa una persona colpita o ferita da scossa elettrica

Un lavoratore infortunato potrebbe trovarsi in luoghi pericolosi quali spazi ristretti, veicoli elettrici, veicoli ibridi e apparecchiature elettriche. Il materiale isolante protegge il soccorritore dalle scosse elettriche.

Rescue Hook is used to remove a person incapacitated by electrical shock or injured from a hazardous location.

An injured worker could be located in dangerous locations such as confined spaces, electric vehicles, hybrid vehicles and electrical equipment. The insulating material protects the rescuer from electric shock.

Cod. 05.090.100

€ 520,00

CASSETTIERA PORTAUTENSILI ISOLATI per i lavori su
vetture ibride (57 utensili inclusi)**TOOL CHEST OF DRAWERS FOR INSULATED TOOLS**
suitable for work on hybrid vehicles (57 tools incl.)

Set di cacciaviti e pinze isolati VDE (11 pz) 11 pcs VDE insulated Tool Set Screwdrivers&Pliers		1 taglierina laterale VDE da 6" 1 pinza combinata VDE da 7" 1 pinza a becchi lunghi VDE da 8" 7 cacciaviti VDE: SL3*75mm, SL4.0*100mm, SL5.5*125mm, SL6.5*150mm, PH0*75mm, PH1*80mm, PH2*100mm 1 tester tensione: 140 mm, CA 200-250 V	1pc 6" VDE Side Cutter 1pc 7" VDE Combination Plier 1pc 8" VDE Long Nose Plier 7pc VDE Screwdriver: SL3*75mm, SL4.0*100mm, SL5.5*125mm, SL6.5*150mm, PH0*75mm, PH1*80mm, PH2*100mm 1pc Voltage tester:140mm,AC 200-250V
Set di 11 cacciaviti isolati VDE Slim Fix 11 pcs Slim Fix VDE Insulated Screwdrivers Set		Dimensioni testa: PZ1*80 mm, PZ2*100 mm, PH1*80 mm, PH2*100 mm, 4,0 mm*100 mm, 5,5 mm*125 mm, 6,5 mm*150 mm, 3,5 mm*100 mm, T15*100 mm, T20*125 mm, T25*125 mm	Head size: PZ1 x 80 mm, PZ2 x 100 mm, PH1 x 80 mm, PH2 x 100 mm, 4.0 mm x 100 mm, 5.5 mm x 125 mm, 6.5 mm x 150 mm, 3.5 mm x 100 mm, T15*100mm, T20 x125mm, T25 x 125mm
Bussole 1/2 e chiave inglese (20pz) 20pcs VDE Insulated Tool Set 1/2 Sockets&Wrench		13 prese VDE da 1/2": 10 mm, 11 mm, 12 mm, 13 mm, 14 mm, 16 mm, 17 mm, 18 mm, 19 mm, 21 mm, 22 mm, 24 mm, 27 mm 4 punte a bussola VDE da 1/2": H4*80mm, H5*80mm, H6*80mm, H8*80mm 1 barra di estensione VDE da 1/2": 250 mm 1 impugnatura a T VDE da 1/2": 200 mm 1 chiave a cricchetto VDE da 1/2": 250 mm	13pc 1/2" VDE sockets: 10mm, 11mm, 12mm, 13mm, 14mm, 16mm, 17mm, 18mm, 19mm, 21mm, 22mm, 24mm, 27mm 4pc 1/2" VDE Socket Bits: H4*80mm, H5*80mm, H6*80mm, H8*80mm 1pc 1/2" VDE Extension Bar: 250mm 1pc 1/2" VDE T Handle: 200mm 1pc 1/2" VDE Ratchet Wrench: 250mm
Set di chiavi esagonali (7pz) 7pcs VDE Insulated Hex Key set		Chiave esagonale isolata VDE (in cromo vanadio). Dimensioni: 3 mm, 4 mm, 5 mm, 6 mm, 8 mm, 10 mm, 12 mm	VDE certified insulated Hex Key. Manufactured from chrome vanadium. Hex Key Size: 3mm, 4mm, 5mm, 6mm, 8mm, 10mm, 12mm
Set di chiavi ad anello (8pz) 8pcs VDE Insulated Ring Spanner Set		Chiavi ad anello isolate VDE Dimensioni: 7 mm, 8 mm, 10 mm, 12 mm, 13 mm, 14 mm, 17 mm, 19 mm	VDE certified insulated Ring Spanner Size: 7mm, 8mm, 10mm, 12mm, 13mm, 14mm, 17mm, 19mm

Tutte le immagini dei prodotti pubblicate in questo catalogo sono puramente indicative e possono essere cambiate senza preavviso.
All product images published in this catalogue have explanatory purposes and can be changed with no warning.

Prezzi promozionali / IVA e trasporto non incluso • Promotional prices • Precios promocionales

PROMO 2024

17

Cod. 05.088.55X € **308,00**

VUOTO / EMPTY / VACIO



Cod. 05.090.99 € **480,00**

3 EVA SET



+

=

€ **788,00**



Cod. 05.088.30 € **110,00**

CASSETTIERA PORTA UTENSILI PORTATILE (VUOTA)
PORTABLE TOOL DRAWER BOX (EMPTY)
CAJONERA PORTAHERRAMIENTAS MÓVIL (VACÍA)



	③ 150x225x30	TOTAL 	KG 11/12
	② 570x225x30		
	① 570x225x30		
		600x260x345	660x31x41

COPERTINE DI NYLON • NYLON COVERS • CUBIERTAS DE NYLON

Cod. 05.088.112 € **9,90**



- Copertina in nylon per carrello 05.088.141
- Colore nero
- Dimensioni: 78,5x52,5x78cm

- Nylon cover for trolley 05.088.141
- Black color
- Size: 78,5x52,5x78cm

Cod. 05.088.113 € **9,90**



- Copertina in nylon per carrelli 05.088.55, 05.088.50R-EVA, B-EVA, G-EVA + 05.088.150
- Colore nero
- Dimensioni: 84x52x82cm

- Nylon cover for 05.088.55, 05.088.50R-EVA, B-EVA, G-EVA + 05.088.150
- Black color
- Size: 84x52x82cm

Tutte le immagini dei prodotti pubblicate in questo catalogo sono puramente indicative e possono essere cambiate senza preavviso.
All product images published in this catalogue have explanatory purposes and can be changed with no warning.

3 SET EVA PER STRUMENTI ISOLATI PER I LAVORI SU VETTURE IBRIDE (CONFORME IEC 60900)

3 EVA SETS FOR INSULATED TOOLS FOR SERVICE ON HYBRID CARS (ACCORDING TO IEC 60900)

3 JUEGOS DE HERRAMIENTAS AISLADAS PARA EL MANTENIMIENTO EN COCHES HÍBRIDOS (SEGÚN IEC 60900)

Cod. 05.090.99 € 480,00

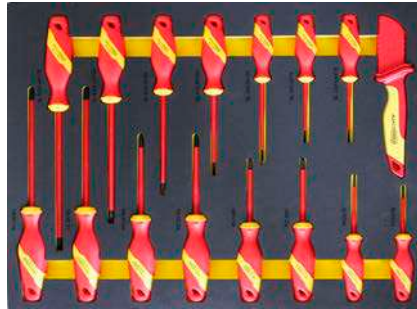
HYBRID
CARSCHROME
VANADIUM

1	Insulated Combination Pliers, 200mm		22	1/2" Insulated Sockets 10mm	
2	Insulated Wire Stripping Pliers, 160mm		23	1/2" Insulated Sockets 11mm	
3	Insulated Flat Nose Pliers, 200mm		24	1/2" Insulated Sockets 12mm	
4	Insulated High Leverage Long Snipe Nose Pliers, 200mm		25	1/2" Insulated Sockets 13mm	
5	Insulated Cable Cutting Pliers, 160mm		26	1/2" Insulated Sockets 14mm	
6	Insulated Slotted Screwdriver, 2.5*0.4*75mm		27	1/2" Insulated Ratchet Wrench 250mm	
7	Insulated Slotted Screwdriver 3*0.5*75mm		28	1/2" Insulated Extension Bar 125mm	
8	Insulated Slotted Screwdriver 3*0.5*100mm		29	1/2" Insulated Extension Bar 250mm	
9	Insulated Slotted Screwdriver 4*0.8*100mm			30	Insulated Ring Wrench 6mm
10	Insulated Slotted Screwdriver 5.5*1*125mm			31	Insulated Ring Wrench 7mm
11	Insulated Slotted Screwdriver 6.5*1.2*150mm	32		Insulated Ring Wrench 8mm	
12	Insulated Slotted Screwdriver 8.0*1.6*175mm	33		Insulated Ring Wrench 9mm	
13	Insulated Phillips Screwdriver PH0*75mm	34		Insulated Ring Wrench 10mm	
14	Insulated Phillips Screwdriver PH1*80mm	35		Insulated Ring Wrench 11mm	
15	Insulated Phillips Screwdriver PH2*100mm	36		Insulated Ring Wrench 12mm	
16	Insulated Phillips Screwdriver PH3*150mm	37		Insulated Ring Wrench 13mm	
17	Insulated Pozidriv Screwdriver PZ0*60mm	38		Insulated Ring Wrench 14mm	
18	Insulated Pozidriv Screwdriver PZ1*80mm	39		Insulated Ring Wrench 15mm	
19	Insulated Pozidriv Screwdriver PZ2*100mm	40	Insulated Ring Wrench 16mm		
20	Insulated Pozidriv Screwdriver PZ3*150mm	41	Insulated Ring Wrench 17mm		
21	VDE Insulated Cable Knife 190mm/208mm (52mm blade)		42	Insulated Ring Wrench 18mm	
			43	Insulated Ring Wrench 19mm	

Tutte le immagini dei prodotti pubblicate in questo catalogo sono puramente indicative e possono essere cambiate senza preavviso.
All product images published in this catalogue have explanatory purposes and can be changed with no warning.

Prezzi promozionali / IVA e trasporto non incluso • Promotional prices • Precios promocionales

PROMO 2024

19

CARRELLO MULTIFUNZIONE • MULTIFUNCTIONAL TROLLEY • CARRO MULTIFUNCIONAL

Cod. 05.088.105

€ 298,00

GOLDEN MATE

Disponibile in versione bicolore / available in bicolor version:
nero / black ■ + argento / silver ■

Cod. 05.088.105/N

€ 298,00

CUSTOM (NO LOGO)



- 1 piano scorrevole per tastiera PC
- Dotato di 3 piani di appoggio
- Porta rotolo
- 3 avvolgicavi in acciaio
- 3 contenitori per materiali di consumo laterali (in acciaio)
- Un vano porta tester con chiave
- 2 ruote fisse e 2 piroettanti (1 con freno)
- Dimensioni (carrello montato): 48x60x107 cm
- Fornito in kit di montaggio
- Dim. imballo 53x108x13 Peso, 42 kg
- Peso: 37 kg

- Equipped with 3 support surfaces
- 1 sliding top for PC keyboard
- Roll holder
- 3 steel cable reels
- 3 side containers for consumables (steel)
- Compartment for other devices with key
- 2 Fixed and 2 swivel castor wheels (1 with brake)
- Dimensioni (carrello montato): 48x60x107 cm
- Supplied in a mounting kit
- Packing size 53x108x13 cm, weight 42kgs
- Weight: 37kgs

UN VERO "COMPAGNO" PER LA TUA ATTIVITÀ DI AUTORIPARATORE
A REAL "BUDDY" FOR YOUR ACTIVITY AS A CAR REPAIRER



Tutte le immagini dei prodotti pubblicate in questo catalogo sono puramente indicative e possono essere cambiate senza preavviso.
All product images published in this catalogue have explanatory purposes and can be changed with no warning.

LOGISTICA DI MAGAZZINO • WAREHOUSE LOGISTICS • LOGÍSTICA DE ALMACÉN

300 Kg



Cod. 05.088.109 € 198,00

CARRELLO 3 PIANI TIPO PESANTE
3-LEVEL HEAVY DUTY TROLLEY

- carrello in acciaio verniciato (uso industriale)
- 2 ruote fisse, 2 piroettanti Ø125 mm con freno
- tappeti in gomma antiolio
- portata 300 kg
- Fornito con il kit di montaggio

- trolley in painted steel (industrial use)
- 2 Fixed wheels, 2 pivoting 125 mm diameter with brake
- Anti-oil rubber mats
- capacity 300 kgs
- In mounting kit



890x500x870



995x570x220



KG

36

Cod. 05.088.02 € 62,00

100 Kg



765x400x845



730x400x180



KG

20

300 Kg



SPECIAL VERSION

Cod. 05.088.109W € 128,00

CARRELLO 3 PIANI TIPO PESANTE / 3-LEVEL HEAVY DUTY TROLLEY

- carrello in acciaio verniciato (uso industriale)
- 2 ruote fisse, 2 piroettanti Ø125 mm con freno
- tappeti in gomma antiolio
- portata 300 kg
- Fornito con il kit di montaggio

Prezzi netti per quantità
Net prices for min. q.ty

- trolley in painted steel (industrial use)
- 2 Fixed wheels, 2 pivoting 125 mm diameter with brake
- Anti-oil rubber mats
- capacity 300 kgs
- In mounting kit



700x400x845



700x400x220



KG

26

Cod. 05.088.79 € 39,90



480x480x1190



119x51x44



KG

9

- Ruote in poliuretano piene
- Solid polyurethane wheels
- Ruedas de poliuretano sólido

Ø 260mm



200 Kg

Cod. 05.088.79.R1 € 13,80

Ruota in poliuretano Ø 260mm
Solid polyurethane wheel Ø 260mm

Cod. 05.088.25 € 39,90



100 Kg



730x475x835



780x490x125



KG

8,1

Cod. 05.088.03 € 34,00



70 Kg



420x420x965



770x460x70



KG

5

Tutte le immagini dei prodotti pubblicate in questo catalogo sono puramente indicative e possono essere cambiate senza preavviso.
All product images published in this catalogue have explanatory purposes and can be changed with no warning.

Prezzi promozionali / IVA e trasporto non incluso • Promotional prices • Precios promocionales

PROMO 2024

21

PROMO 2024

IL MIGLIOR RAPPORTO FUNZIONALE E SALVA COSTI DI LOGISTICA
IDEALE PER PICCOLE/MEDIE OFFICINE E PER LA VENDITA ONLINE

Cod. 05.088.127

€ **1.660,00**



THE BEST FUNCTIONAL AND
COST SAVING RATIO ON
LOGISTICS COSTS.
IDEAL FOR SMALL/MEDIUM
WORKSHOPS AND FOR ONLINE
SALES.

LA MEJOR RELACIÓN FUNCIONAL
Y DE AHORRO EN COSTES
LOGÍSTICOS
IDEAL PARA TALLERES
PEQUEÑOS/MEDIANOS Y PARA
VENTAS ONLINE

Disponibile solo in colore nero-grigio RAL 7011 / in black-grey RAL 7011 color available only

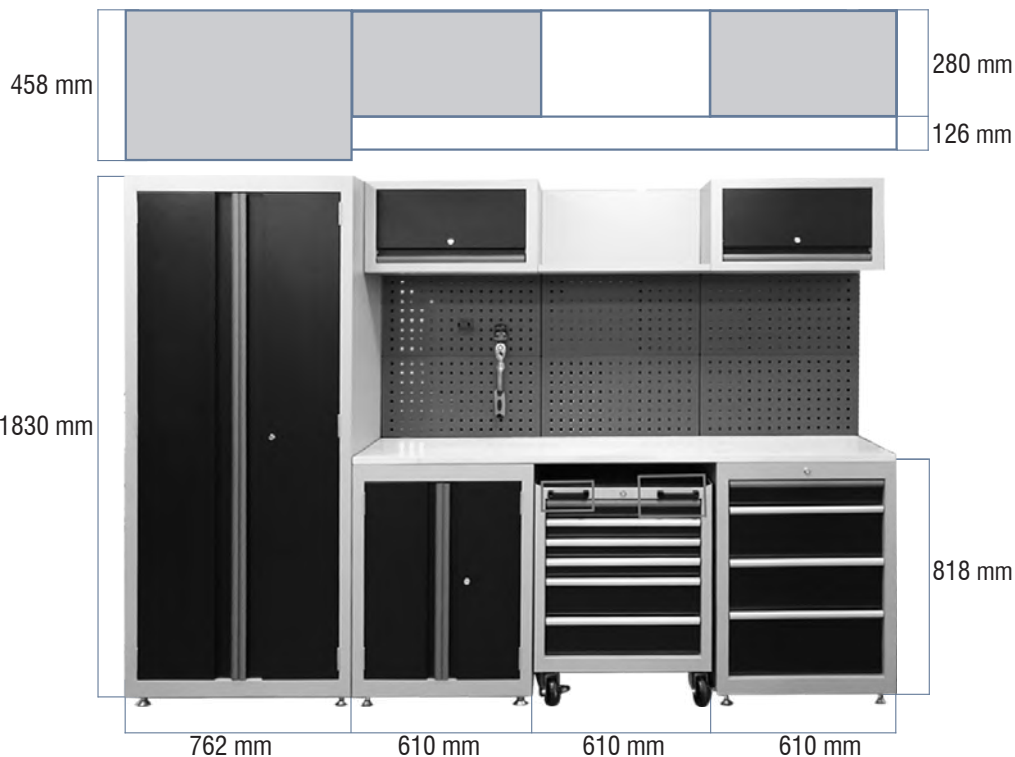



**DIMENSIONI IMBALLO
SHIPPING DIMENSIONS**

120 x 83 x h212 cm
210 kg



Tutte le immagini dei prodotti pubblicate in questo catalogo sono puramente indicative e possono essere cambiate senza preavviso.
All product images published in this catalogue have explanatory purposes and can be changed with no warning.

COMPOSIZIONE ARREDO PER OFFICINA •
WORKSHOP FURNITURE COMPOSITION • COMPOSICIÓN MUEBLES DE TALLER

 <p>762 x 458 x 1830mm</p>	<p>05.088.127.R1 € 590,00*</p> <p><i>*Prezzo solo dell'armadio/price for the 2-door cabinet</i></p> <ul style="list-style-type: none"> armadio a due porte, 3 ripiani chiusura centrale con chiave e due magneti, struttura saldata 4 piedi regolabili in altezza two-door cabinet, 3 shelves central locking with key and two magnets 4 feet adjustable in height 	<p>*</p>  <p>610x406x783mm</p>	<p>Carrello vuoto 6 cassetti 6 Ripiani in gomma 15 mm inclusi Empty trolley 6 drawers 6 EVA 15 mm included</p>
<p>*</p>  <p>610x280x338mm</p>	<ul style="list-style-type: none"> pensile con anta basculante con ammortizzatore wall unit with tilting door with shock absorber 	<p>*</p> 	<p>8 ganci / supporti inclusi 8 hooks / holders included</p>
<p>*</p>  <p>610x406x758mm</p>	<ul style="list-style-type: none"> armadietto inferiore a 2 ante un ripiano (0,7mm) chiusura centrale con chiave a due magneti 4 piedi regolabili in altezza lower cabinet with 2 doors one shelf (0,7mm) central locking with two-magnet key. 4 height adjustable feet 	<p>*</p>  <p>610x280x338mm</p>	<p>6 pannelli forati porta utensili Foro quadrato: 10x10mm, Distanza tra i fori: 38x38mm 6 perforated tool panels Square hole: 10x10mm, Hole spacing: 38x38mm</p>
<p>*</p>  <p>610x406x758mm</p>	<ul style="list-style-type: none"> cassettiera a 4 cassetti guide su cuscinetti maniglie in alluminio, 4 piedi reglabili in altezza ripiani in gomma 15 mm incl. chest of 4 drawers guides on bearings Aluminum handles 4 feet adjustable in height 15 mm EVA incl. 	<p>*</p>  <p>610x324x24mm</p>	<p>Ripiano superiore aperto Upper open shelf</p>
<p>*</p>  <p>1830x406x25mm</p>		<p>*</p> 	<p>1 piano di lavoro in acciaio inox 1 worktop in stainless steel</p>
		<p>*</p> 	<p>4 barre di fissaggio 1750x60mm 4 fixing bars 1750x60mm</p>

***** non vendibile singolarmente / not for individual sale / no por la venta individual

**POTRESTI AGGIUNGERE...
WHAT ABOUT ADDING...
POR QUÈ NO AÑADES...**

Cod. 05.088.138.R1

€ 244,00

**CHROME
VANADIUM**



**Vedi pg. 25 per dettagli e misure
See pag. 25 for details and measurements
Ver pág. 25 para detalles y medidas**

ARREDO PER OFFICINA • WORKSHOP FURNITURE • MUEBLES DE TALLER

Cod. 05.088.152

€ 1.395,00

ARREDO PER OFFICINA "DELUXE", 16 PZ

- IL MODULO BASE MA CON CARATTERISTICHE "DELUXE" PER OGNI TIPO DI OFFICINA
- SPESSORI LAMIERA VERNICIATA E INOX 0,8 MM
- AMPIO PIANO DI LAVORO

16 PCS "DELUXE" WORKSHOP FURNITURE

- THE BASIC MODULE BUT WITH "DE LUXE" FEATURES FOR EVERY TYPE OF WORKSHOP
- PAINTED AND STAINLESS STEEL SHEET THICKNESS 0.8 MM
- LARGE WORKTOP

"DE LUXE" MUEBLES DE TALLER, 16 PIEZAS

- EL MÓDULO BÁSICO PERO CON CARACTERÍSTICAS "DELUXE" PARA CADA TIPO DE TALLER
- CHAPA DE ACERO INOXIDABLE Y PINTADO ESPESOR 0,8 MM
- GRAN ENCIMERA

Disponibile solo in colore grigio RAL 7011 (finiture in rosso)
Available only gray color RAL 7011 (with red handles)



1854 mm



611 mm

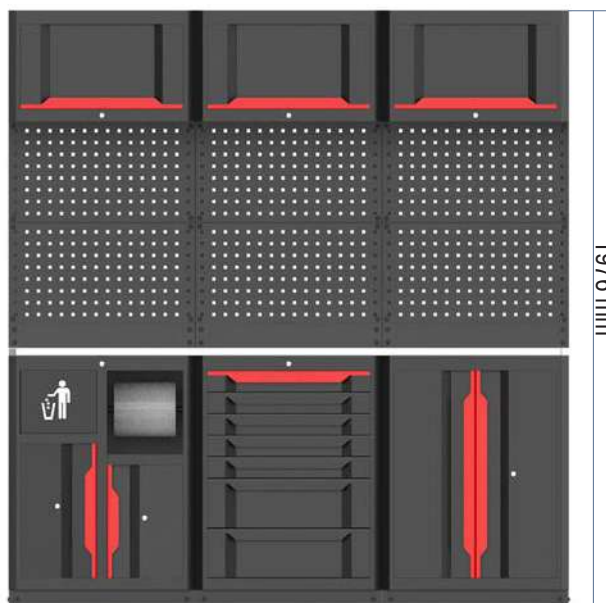

1976 mm







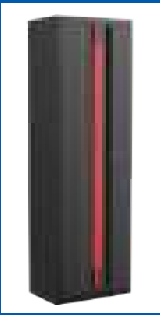

DIMENSIONI IMBALLO
SHIPPING DIMENSIONS

120 x 80 x h215 cm
250 kg



Tutte le immagini dei prodotti pubblicate in questo catalogo sono puramente indicative e possono essere cambiate senza preavviso.
All product images published in this catalogue have explanatory purposes and can be changed with no warning.

COMPOSIZIONE ARREDO PER OFFICINA * •
WORKSHOP FURNITURE COMPOSITION * • COMPOSICIÓN MUEBLES DE TALLER *

 <p>755 x 600 x 1916 mm</p>	<p>05.088.152.R1 € 590,00*</p> <p>*Prezzo solo dell'armadio/price for the 2-door cabinet</p> <ul style="list-style-type: none"> • armadio a due porte, 3 ripiani • chiusura centrale con chiave e due magneti, struttura saldata • 4 piedi regolabili in altezza • two-door cabinet, 3 shelves • central locking with key and two magnets • 4pcs of adjustable feet 	 <p>618x530x776/836mm 1 pz/pcs</p> <ul style="list-style-type: none"> • Cassetiera fissa a 7 cassetti • 5-500*398*74mm, 2-500-398*125mm • 7 cassetti con cuscinetti a sfera per carichi pesanti • Chiusura centralizzata con serratura a cilindro 2 chiavi • 4 piedini regolabili • 7-door cabinet • 5-500*398*74mm, 2-500-398*125mm • 7 heavy duty ball-bearing drawers • Central locking system with cylinder lock 2pcs key • 4pcs of adjustable feet
 <p>618x360x372 mm 3 pz/pcs</p>	<ul style="list-style-type: none"> • Pensile con anta basculante (3 pz) • 2 pistoni a gas • Chiavi, 2 pz • 1-door wall cabinet (3 pcs) • 2pcs of gas struts • 2pcs key 	 <p>1236*530*38mm 1 pz/pcs</p> <ul style="list-style-type: none"> • 1 piano di lavoro in acciaio inox • 1 worktop in stainless steel • 0.8mm stainless steel • 1 worktop in stainless steel
 <p>618x530x776/836mm 1 pz/pcs</p>	<ul style="list-style-type: none"> • Armadio basso con 2 ante e serratura • 2-door Tool cabinet • Central locking system with cylinder lock 2pcs key • 4pcs of adjustable feet 	 <p>618*324*26mm 6 pz/pcs</p> <ul style="list-style-type: none"> • 6 pannelli forati porta utensili • Foro quadrato: 10x10mm, Distanza tra i fori: 38x38 mm • 6 perforated tool panels • Square hole: 10x10mm, Hole spacing: 38x38mm
 <p>618x530x776/836mm 1 pz/pcs</p>	<ul style="list-style-type: none"> • Armadio con modulo porta carta e porta rifiuti • Trash bin with paper holder • 1 set of heavy duty ball-bearing slides • Central locking system with cylinder lock • 4pcs of adjustable feet 	 <p>1916*60*30mm 4 pz/pcs</p> <ul style="list-style-type: none"> • 4 barre di fissaggio 1750x60mm • 4 fixing bars 1750x60mm
		 <p>618*80*26mm 3 pz/pcs</p> <ul style="list-style-type: none"> • Piani fissaggio retro • Backplane

* non vendibile singolarmente / not for individual sale / no por la venta individual

POTRESTI AGGIUNGERE...
WHAT ABOUT ADDING...
POR QUÈ NO AÑADES...

Cod. 05.088.138.R1

€ **244,00**

CHROME
VANADIUM



Vedi pg. 25 per dettagli e misure
See pag. 25 for details and measurements
Ver pág. 25 para detalles y medidas

Tutte le immagini dei prodotti pubblicate in questo catalogo sono puramente indicative e possono essere cambiate senza preavviso.
All product images published in this catalogue have explanatory purposes and can be changed with no warning.

Prezzi promozionali / IVA e trasporto non incluso • Promotional prices • Precios promocionales

PROMO 2024

25

PROMO 2024

ACCESSORI A RICHIESTA PER ARREDI OFFICINA:
OPTIONAL ACCESSORIES FOR THE WORKSHOP FURNITURES:
ACCESORIOS OPCIONALES PARA MUEBLES DE TALLER:

COD. 05.088.127
+
COD. 05.088.152



Cod. 05.088.152/A1

€ **46,00**

CASSETTIERA PORTA MINUTERIA (5 CASSETTI)
CHEST OF DRAWERS FOR SMALL PARTS (5 DRAWERS)
CAJONERA PARA PIEZAS PEQUEÑAS (5 CAJONES)



Cod. 05.088.152/A2

€ **44,00**

PIANO APPOGGIO LAPTOP
LAPTOP SUPPORT SURFACE
SUPERFICIE DE APOYO PARA PORTÁTIL
Dimensioni/dimensions/dimensiones: 398x243x138 mm
Portata/capacity/capacidad: 5kgs



Cod. 05.088.152/A3

€ **48,00**

CESTELLO PORTA BOMBOLETTE DA PARETE
WALL-MOUNTED CAN-HOLDER RACK
PORTA-LATAS DE PARED
Dimensioni/dimensions/dimensiones: 280x215x95mm

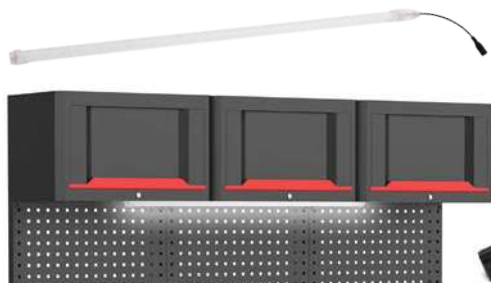

Cod. 05.088.152/A4

€ **68,00**

LAMPADA CON MAGNETI E ALIMENTATORE 100/240V AC / 12V DC
LAMP WITH MAGNETS AND POWER SUPPLY 100/240V AC / 12V DC
LÁMPARA CON IMANES Y ALIMENTACIÓN 100/240V AC / 12V DC

SERIE DI GANCI E SUPPORTI PER PANNELLI FORATI. Prezzi/quantità a richiesta
PEGBOARD HOOKS FOR TOOLS. Prices/quantity on request

GANCIO DOPPIO / 2 SHORT PIN HOOK / DOBLE GANCHO



Cod. 05.088.131/25 € **3,20**

Cod. 05.088.131/50 € **3,20**

Cod. 05.088.131/75 € **3,60**

Cod. 05.088.131/100 € **3,60**

Cod. 05.088.131/150 € **4,00**

Cod. 05.088.131/200 € **4,00**

Cod. 05.088.132 € **7,00**

SUPPORTO PER BUSSOLE
HOLDER FOR SOCKETS
SOPORTE DE BRÚJULA



Cod. 05.088.133 € **13,80**

SUPPORTO PER CACCIAVITI
HOLDER FOR SCREWDRIVERS
SOPORTE PARA DESTORNILLADORES



Cod. 05.088.138.R1

€ 244,⁰⁰CHROME
VANADIUM**SET DI BUSSOLE, 108 PZ**

- 1x chiave a cricchetto universale da 1/2"
- 1x adattatore da 1/2"*5/16"
- 5 bussole profonde 1/2" (6PT): 14, 15, 17, 19 e 22 mm
- 17 bussole metriche da 1/2" (6PT): 10, 11, 12, 13, 14, 15, 16, 17, 18, 19, 20, 21, 22, 24, 27, 30 e 32 mm
- 8 bussole a stella da 1/2": E10, E11, E12, E14, E16, E18, E20 e E24
- 2 bussole per candele da 1/2": 16 mm e 21 mm
- 2x barre di prolunga: 5" e 10" con testa scorrevole
- 1 giunto cardanico da 1/2"
- 1x impugnatura a cricchetto universale da 1/4"
- 18 bussole punte: PH: #1, #2 / PZ: #1 e #2 / HEX: 3, 4, 5, 6 mm / SL: 4, 5,5, 6,5 mm / TX: 8, 10, 15, 20, 25, 27, 30 mm
- 1 maniglia rotante da 1/4"
- 1 giunto cardanico da 1/4"
- 1 maniglia scorrevole da 1/4"
- 2x barre di estensione: 2", 5"
- 13 bussole metriche (6PT): 4, 4,5, 5, 5,5, 6, 7, 8, 9, 10, 11, 12, 13, 14 mm
- 8 prese profonde da 1/4" (6PT): 6, 7, 8, 9, 10, 11, 12 e 13 mm
- 5 prese a stella da 1/4": E4, E5, E6, E7 ed E8
- 17 punte (8 mm): HEX: 7, 8, 10, 12, 14 mm / SL: 8, 10, 12 mm / PH: #3, #4 / PZ: #3, #4 / TX: 40, 45, 50, 55, 60 mm
- 3 chiavi a brugola: 1,5, 2, 2,5 mm

108 PCS SOCKET SET TOOL TRAY

- 1x 1/2" universal ratchet handle
- 1x 1/2"*5/16" head adapter
- 5x 1/2" deep sockets (6PT): 14, 15, 17, 19, and 22 mm
- 17x 1/2" metric sockets (6PT): 10, 11, 12, 13, 14, 15, 16, 17, 18, 19, 20, 21, 22, 24, 27, 30, and 32 mm
- 8x 1/2" star sockets: E10, E11, E12, E14, E16, E18, E20 and E24
- 2x 1/2" spark plug sockets: 16 mm and 21 mm
- 2x extension bars: 5" and 10" with sliding head
- 1x 1/2" universal joint
- 1x 1/4" universal ratchet handle
- 18x bit sockets: PH: #1, #2 / PZ: #1 and #2 / HEX: 3, 4, 5, 6 mm / SL: 4, 5.5, 6.5 mm / TX: 8, 10, 15, 20, 25, 27, 30 mm
- 1x 1/4" spin handle
- 1x 1/4" universal joint
- 1x 1/4" slide handle
- 2x extension bars: 2", 5"
- 13x metric sockets (6PT): 4, 4.5, 5, 5.5, 6, 7, 8, 9, 10, 11, 12, 13, 14 mm
- 8x 1/4" deep sockets (6PT): 6, 7, 8, 9, 10, 11, 12, and 13 mm
- 5x 1/4" star sockets: E4, E5, E6, E7, and E8
- 17x bits (8 mm): HEX: 7, 8, 10, 12, 14 mm / SL: 8, 10, 12 mm / PH: #3, #4 / PZ: #3, #4 / TX: 40, 45, 50, 55, 60 mm
- 3x Allen keys: 1.5, 2, 2.5 mm

**SET DI CACCIAVITI E CHIAVI A "L", 30 PZ**

- Cacciavite a croce - 2x38 mm / PH 0x75 mm / PH 1 x 100 mm / PH 2 x 100 mm / PH 3 x 150 mm / PH 4 x 200 mm
- Cacciavite a taglio - SL 6x38 mm / SL 3x100 mm / SL 5x75 mm / SL 6x100 mm / SL 8x150 mm / SL 10x200 mm
- Set di 9 chiavi a brugola a "L" con estremità tonda
- Set di 9 chiavi torx a "L"

30 PCS SCREWDRIVER AND "L" KEY SET TRAY

- Phillips screwdriver - 2x38 mm / PH 0x75 mm / PH 1 x 100 mm / PH 2 x 100 mm / PH 3 x 150 mm / PH 4 x 200 mm
- Slotted screwdriver - SL 6x38 mm / SL 3x100 mm / SL 5x75 mm / SL 6x100 mm / SL 8x150 mm / SL 10x200 mm
- Set of 9 allen keys "L" shaped with round end
- Set of 9 torx keys "L" shaped

**SET DI CHIAVI, 25 PZ**

- Chiave doppia ad anello: 6x7mm, 8x9mm, 10x11mm, 12x13mm, 14x15mm, 16x17mm, 18x19mm, 20x22mm
- Chiave combinata: 6-7-8-9-10-11-12-13-14-15-16-17-18-19-20-21-22 mm

25 PIECE SPANNER SET TRAY

- Double end ring spanner: 6x7mm, 8x9mm, 10x11mm, 12x13mm, 14x15mm, 16x17mm, 18x19mm, 20x22mm
- Combination spanner: 6-7-8-9-10-11-12-13-14-15-16-17-18-19-20-21-22mm

**SET MARTELLI E PINZE, 9 PZ**

- Martello a penna sferica
- Mazzuola antirimbalzo
- Pinza per pompa acqua 10"
- Pinze per anelli elastici interni da 7" (punte dritte)
- Pinze per anelli elastici esterni 7" (punte dritte)
- Pinza di bloccaggio 10"
- Pinza diagonale 7,5"
- Pinza a becco lungo 8"
- Metro a nastro, 3m

9 PCS HAMMER AND PLIER SET TRAY

- Ball peen hammer
- Install hammer
- Water pump plier 10"
- 7" internal circlip pliers (straight tips)
- 7" external circlip pliers (straight tips)
- Locking plier 10"
- Diagonal plier 7.5"
- Long nose plier 8"
- Measuring tape 3m

Tutte le immagini dei prodotti pubblicate in questo catalogo sono puramente indicative e possono essere cambiate senza preavviso.
All product images published in this catalogue have explanatory purposes and can be changed with no warning.

Prezzi promozionali / IVA e trasporto non incluso • Promotional prices • Precios promocionales

PROMO 2024

27

Cod. 05.088.135

€ 258,00

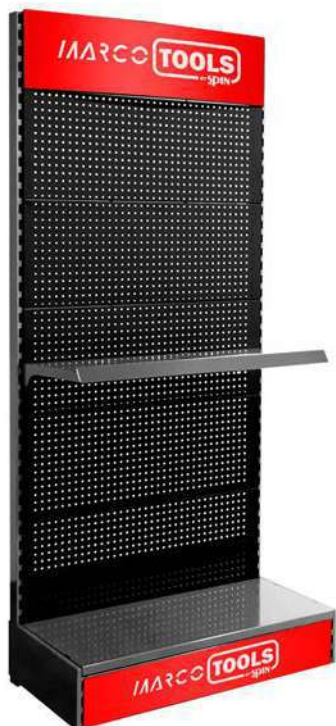

**ESPOSITORE CON PANNELLI FORATI PORTAUTENSILI
PERFORATED TOOL-HOLDER PANEL
PANEL PORTAHERRAMIENTAS PERFORADO**

- 5 pannelli perforati, 96x35 cm, fori tondi
- 3 ripiani: 96,8x35 cm
- 20 ganci in acciaio cromato
- 2 piedini di livellamento in altezza
- Dimensioni: 100x50x220 cm
- Dim. imballo: 123x53x15 cm
- Peso: 35,7 / 37,7 kg

- 5 perforated panels, 96x35 cm, round holes
- 3 shelves: 96.8x35 cm
- 20 hooks in chromed steel
- 2 x height leveling feet
- Dimensions: 100x50x220 cm
- Packing size: 123x53x15 cm
- Weight: 35.7 / 37.7 kg

- 5 paneles perforados, 96x35 cm, agujeros redondos
- 3 estantes: 96.8x35 cm
- 20 ganchos en acero cromado
- 2 x pies niveladores de altura
- Dimensiones: 100x50x220 cm
- Tamaño del embalaje: 123x53x15 cm
- Peso: 35,7 / 37,7 kg

Cod. 05.088.136

€ 520,00



**ARMADIO CON PANNELLI FORATI PORTAUTENSILI
CABINET WITH TOOL HOLDER PERFORATED PANELS
ARMARIO CON PANELES PERFORADOS PORTAHERRAMIENTAS**

- 5 pannelli forati 96x35 cm, fori tondi
- 3 ripiani: 92,6x30 cm
- 2 faretti LED 3W, presa Schuko
- 20 ganci in acciaio cromato
- 2 maniglie x sportello, serratura inclusa
- 2 piedini di livellamento in altezza
- Dimensioni: 100x50x220 cm
- Dim. imballo: 1) 123x53x15, 2)100x48x28, 3)177x50x13 cm
- Peso: 35,7 / 37,7 kg

- 5 pcs perforated panels 96x35 cm, round holes
- 3 pcs shelves: 92,6x30 cm
- 2pcs. 3W LED spotlight, Schuko power plug
- 20 pcs chrome plate steel hooks
- 2pcs door handle, incl.lock
- 2 pcs height levelling feet
- Dimensions: 100x50x220 cm
- Packaging: 1) 123x53x15, 2)100x48x28, 3)177x50x13 cm
- Weight: 35,7/37,7 kg

- 5 paneles perforados 96x35 cm, agujeros redondos
- 3 baldas: 92,6x30 cm
- 2 luz LED 3W, enchufe de alimentación Schuko
- 20 ganchos en acero cromado
- 2 manijas de puerta, cerradura incluida
- 2 pies niveladores de altura
- Dimensiones: 100x50x220 cm
- Tamaño del embalaje: 1) 123x53x15, 2) 100x48x28, 3) 177x50x13 cm
- Peso: 35,7 / 37,7 kg

Tutte le immagini dei prodotti pubblicate in questo catalogo sono puramente indicative e possono essere cambiate senza preavviso.
All product images published in this catalogue have explanatory purposes and can be changed with no warning.

TAVOLI DA LAVORO FOLDABLE WORK BENCHES MESAS DE TRABAJO

Cod. 05.088.149

€ 153,⁰⁰

TAVOLO DA LAVORO CON PANNELLO PORTA CHIAVI FOLDABLE WORK BENCH WITH TOOLS HOLDER PANEL BANCO DE TRABAJO PLEGABLE CON PANEL PORTAHERRAMIENTAS



- Plano in legno multistrato
- Dimensioni (montato): 120x64xh144 cm
- Imballo 132x173x10 cm
- Peso 30,6 kg
- multi-layer wood top
- Dimensions (assembled): 120x64xh144 cm
- Packaging 132x173x10 cm
- Weight 30.6 kg
- Plano en madera multicapa
- Dimensiones (montado): 120x64xh144 cm
- Embalaje 132x173x10 cm
- Peso 30,6 kg

Cod. 05.088.73

€ 290,⁰⁰

800 kg



- 1.6 mt, 1 cassetto, 1 ripiano inferiore
- Lamiera piano appoggio da 30/10, altezza bordi 40mm
- Cassetto con guida su cuscinetti e chiave
- In kit di montaggio
- 1.6 mt, 1 drawer, 1 lower rack.
- Sheet metal worktop thickness 30/10, height of edges: 40mm
- Drawer with guide bearings and key
- In mounting kit
- 1.6mt, 1 cajón, 1 estante inferior
- Espesor de la plancha de metal de trabajo de 30/10, altura de los bordes 40mm
- Cajon con cojinetes de guía y clave
- Kit de montaje

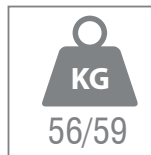

Cod. 05.088.74

€ 396,⁰⁰

1000 kg



- 2 mt, 2 cassetti, 1 ripiano inferiore, 6 gambe
- Lamiera piano appoggio da 30/10, altezza bordi 40mm
- 2 cassetti con guida su cuscinetti e chiave
- In kit di montaggio
- 2 mt, 2 drawers, 1 lower rack.
- Sheet metal worktop thickness 30/10, height of edges: 40mm
- 2 drawers with guide bearings and key
- In mounting kit
- 2mt, 2 cajones, 1 estante inferior
- Espesor de la plancha de metal de trabajo de 30/10, altura de los bordes 40mm
- 2 cajones con cojinetes de guía y clave
- Kit de montaje

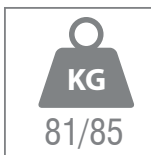

Tutte le immagini dei prodotti pubblicate in questo catalogo sono puramente indicative e possono essere cambiate senza preavviso.
All product images published in this catalogue have explanatory purposes and can be changed with no warning.

Prezzi promozionali / IVA e trasporto non incluso • Promotional prices • Precios promocionales

PROMO 2024

29

Cod. 05.088.128

€ 124,00

SET DI 3 CONTENITORI PORTA TUTTO IN TELAIO DI ALLUMINIO
per lavoro - tempo libero - sport

SET OF 3 STORAGE BOXES IN ALUMINUM FRAME
for work - leisure - sport

JUEGO DE 3 CAJAS DE ALMACENAMIENTO CON ESTRUCTURA DE ALUMINIO
para el trabajo - tiempo libre - deporte

- Materiale: alluminio - ABS - 3,9mm MDF + 2mm EVA
- Piccolo: 47,5x26x21 cm
- Medio: 68x31x32 cm
- Grande: 73x38x36 cm
- Non vendibili separatamente
- Dimensioni imballo: 76,5x41x41 cm / peso: 12,7 kg

- Material: aluminum - ABS - 3,9mm MDF + 2mm EVA
- Small: 47.5x26x21 cm
- Medium: 68x31x32 cm
- Large: 73x38x36 cm
- Not for separate sale
- Packaging dimensions: 76.5x41x41 cm / weight: 12.7 kg

- Material: aluminio - ABS - MDF de 3,9 mm + EVA de 2 mm
- Pequeño: 47,5x26x21 cm
- Mediano: 68x31x32 cm
- Grande: 73x38x36 cm
- No para venta separada
- Dimensiones del embalaje: 76,5x41x41 cm / peso: 12,7 kg



Cod. 05.088.137

€ 598,00

SET DI 3 CONTENITORI IN ALLUMINIO AD ALTA RESISTENZA
ideali per i settori autocarro/edilizia/idraulica/cantieri

SET OF 3 HIGH RESISTANCE ALUMINUM CONTAINERS
suitable for the truck / construction / hydraulics / worksites sector

JUEGO DE 3 CONTENEDORES DE ALUMINIO DE ALTA RESISTENCIA
adecuado para los sectores de camiones / construcción / hidráulica / lugares de trabajo

- Medio: 76,5x35,3x25,4 cm; 5,5 kg
- Grande: 123x38x38 cm; 12 kg
- Extra grande: 145x52x46 cm; 19 kg
- Dimensioni imballo 3 in one: 147x54x48 cm / peso: 41 kg

- Medium: 76.5x35.3x25.4 cm; 5.5 kg
- Large: 123x38x38 cm; 12 kg
- Extra Large: 145x52x46 cm; 19 kg
- 3 in one packaging dimensions: 147x54x48 cm / weight: 41 kg

- Medio: 76,5x35,3x25,4 cm; 5,5 kg
- Grande: 123x38x38 cm; 12 kg
- Extra grande: 145x52x46 cm; 19 kg
- Dimensiones embalaje 3 en uno: 147x54x48 cm / peso: 41 kg



① Cod. 05.088.137.R2 € 132,00

② Cod. 05.088.137.R3 € 228,00

③ Cod. 05.088.137.R4 € 369,00

Cod. 03.036.36

€ 210,00

- Robusta struttura in polietilene
- Piano in polietilene rimovibile
- Con valvola di scarico
- Dimensioni: 130x68x30cm
- Peso 22 kg
- Stoccaggio salvaspazio

- Sturdy polyethylene structure
- Removable polyethylene top
- With drain valve
- Dimensions: 130x68x30cm
- Weight 22 kg
- Space-saving storage

- Robusta estructura de polietileno
- Tapa de polietileno extraíble
- Con válvula de drenaje
- Dimensiones: 130x68x30cm
- Peso 22 kilogramos
- Almacenamiento que ahorra espacio

VASCA RACCOGLI OLIO IN PLASTICA

idonea per 6 contenitori di stoccaggio da 60 lt/cad

OIL COLLECTION PLASTIC TANK

suitable for 6 storage containers of 60 lt/each

TANQUE EN PLÁSTICO PARA LA RECOGIDA DE ACEITE

apto para 6 contenedores de 60 lt cada uno

**STOCCAGGIO SALVASPAZIO**

Fino a 20 pz impilabili

SPACE-SAVING PRODUCT

Stackable up to 20pcs

PRODUCTO AHORRA-ESPACIO

Apilable hasta 20pcs



Cod. 03.036.32

€ 320,00

VASCA RACCOGLI OLIO IN PLASTICA

idonea per 3 contenitori da 220 lt/cad + 2 contenitori da 60 lt/cad

OIL COLLECTION PLASTIC TANK

suitable for 3 tanks of 220 lt/each + 2 tanks of 60 lt/each

TANQUE EN PLÁSTICO PARA LA RECOGIDA DE ACEITE

apto para 3 depósitos de 220 lt/cada uno y apto para 2 depósitos de 60 lt/cada uno



- Robusta struttura in polietilene
- Piano in polietilene rimovibile
- Con valvola di scarico
- Capacità dinamica: 1500 kg
- Dimensioni: 130x130x30cm
- Peso 36 kg
- Stoccaggio salvaspazio

- Sturdy polyethylene structure
- Removable polyethylene top
- With drain valve
- Dynamic load: 1500 kg
- Dimensions: 130x130x30cm
- Weight 36 kg
- Space-saving storage

Cod. 05.088.70

€ 21,90

- 450x80x320 mm



Cod. 05.088.69

€ 17,90

- 360x65x280 mm



Cod. 05.083.03

€ 46,00

SGABELLO REGOLABILE CON PORTAUTENSILI
ADJUSTABLE STOOL WITH TOOL-HOLDER
TABURETE AJUSTABLE CON PORTAHERRAMIENTAS

- Portata / Capacity / Capacidad: 130kg
- Altezza max / Max. height / Longitud max: 540mm
- Altezza min / min. height / Longitud min.: 420mm



Cod. 05.083.02

€ 26,40

SGABELLO FISSO CON QUATTRO RUOTE E PORTA UTENSILI
STOOL WITH FOUR WHEELS AND TOOLS-HOLDER
TABURETE CON CUATRO RUEDAS Y PORTA-HERRAMIENTAS

- Weight / Peso: 3,8kgs
- Dim: 360x365x365mm



Tutte le immagini dei prodotti pubblicate in questo catalogo sono puramente indicative e possono essere cambiate senza preavviso.
 All product images published in this catalogue have explanatory purposes and can be changed with no warning.

Prezzi promozionali / IVA e trasporto non incluso • Promotional prices • Precios promocionales

PROMO 2024

31

Cod. 05.084.37

€ **350,00**

TRANSPALLET 2,5 TON
HAND PALLET TRUCK 2,5 TONS
TRANSPALETA 2,5 TON

Prezzi netti per quantità / Net prices for min. q.ty

- Capacità: 2,5 ton
- Ampiezza forche: 550 mm
- Lunghezza forche: 1100 mm
- Altezza min forche: 85 mm
- Altezza max forche: 205 mm
- Ruote doppie anteriori e posteriori in poliuretano
- Peso netto: 61 kg
- Capacity: 2.5 tons
- Fork width: 550 mm
- Fork length: 1100 mm
- Min fork height: 85 mm
- Max fork height: 205 mm
- Double front and rear wheels in polyurethane
- Net weight: 61 kg
- Capacidad: 2,5 toneladas
- Ancho horquillas: 550 mm
- Longitud horquillas: 1100 mm
- Altura mín. horquillas: 85 mm
- Altura máx. horquillas: 205 mm
- Ruedas delanteras y traseras dobles en poliuretano
- Peso neto: 61 kg

Cod. 05.084.38

€ **360,00**

TRANSPALLET 2,5 TON FORCHE CORTE
HAND PALLET TRUCK 2,5 TONS SHORT FORKS
TRANSPALETA 2,5 TON HORQUILLAS CORTAS

- Ampiezza forche: 540 mm
- Lunghezza forche: 900 mm
- Fork width: 540 mm
- Fork length: 900 mm
- Ancho horquillas: 540 mm
- Longitud horquillas: 900 mm

Prezzi netti per min. quantità >6pz

Net prices for min. quantity order of >6pz

Precios netos para pedidos de cantidad mínima de >6pz



PIATTAFORME MOBILI A FORBICE CON SOLLEVAMENTO A PEDALE
MOBILE SCISSOR LIFTING PLATFORM WITH PEDAL SYSTEM
PLATAFORMA ELEVADORA MÓVIL DE TIJERA CON SISTEMA DE PEDAL

Cod. 05.084.35

€ **504,00**

A FORBICE SINGOLA • SINGLE-SCISSOR • TIJERA SIMPLE



- Capacità/ Capacity/ Capacidad: 500 kg
- Pompa a pedale/ Pedal pump/bomba de pedal
- Altezza/ Height/ Altura min.: 390 mm
- Altezza/ Height/ Altura max.: 900 mm
- Dim. piattaforma/ Platform/ plataforma: 815x500x55mm
- Ruote girevoli/ Caster wheels/ Ruedas giratorias: Ø 127
- Dim. imballo/ Packaging/ embalaje: 900x520x390mm
- Peso/ Weight: 81 kg

Cod. 05.084.28

€ **585,00**

A DOPPIA FORBICE • DOUBLE-SCISSOR • DOBLE TIJERA



- Capacità/ Capacity/ Capacidad: 300 kg
- Pompa a pedale/ Pedal pump/bomba de pedal
- Altezza/ Height/ Altura min.: 395 mm
- Altezza/ Height/ Altura max.: 1300 mm
- Dim. piattaforma/ Platform/ plataforma: 905x512x55mm
- Ruote girevoli/ Caster wheels/ Ruedas giratorias: Ø 127
- Dim. imballo/ Packaging/ embalaje: 1000x520x420mm
- Peso/ Weight: 100 kg

Tutte le immagini dei prodotti pubblicate in questo catalogo sono puramente indicative e possono essere cambiate senza preavviso.
All product images published in this catalogue have explanatory purposes and can be changed with no warning.

Cod. 05.085.27

€ 2.850,00



DISPONIBILE DA GIUGNO 2024 / AVAILABLE FROM JUNE 2024 / DISPONIBLE A PARTIR DE JUNIO 2024

PIATTAFORMA ELETTRO-IDRAULICA CON DOPPIO PISTONE E PIANO ALLUNGABILE E INCLINABILE*per motori, cambi e pacchi batterie al litio di vetture ibride***ELECTROHYDRAULIC PLATFORM WITH DOUBLE PISTON AND EXTENDABLE AND TILTING PLATFORM***for engines, gear boxes and lithium battery packs of hybrid cars***PLATAFORMA ELECTROHIDRÁULICA DE DOBLE PISTÓN Y PLATAFORMA EXTENSIBLE E INCLINABLE***para motores, cajas de cambios y paquetes de baterías de litio de automóviles híbridos*1200
Kg

- Altezza max.: 191,5 cm
- Altezza min.: 56 cm
- Dimensioni piattaforma: 130x77 cm
- Circuito elettro-idraulico con doppio pistone
- Sicurezza meccanica a cremagliera, doppio cilindro (A)
- Comando a distanza (B)
- Capacità: 1200 kg
- Dimensioni imballo in legno: 163x88x75 cm
- Peso netto/lordo: 418/460 kg

- Max. Height: 191,5 cm
- Min. height: 56 cm
- Platform dimensions: 130x77 cm
- Electro-hydraulic circuit with double piston
- Mechanical safety, double cylinder (A)
- Remote control (B)
- Capacity: 1200kg
- Wooden packaging dimensions: 163x88x75 cm
- Net/gross weight: 418/460 kg

- Altura máxima: 191,5 cm
- Altura mínima: 56 cm
- Dimensiones plataforma: 130x77 cm
- Circuito electrohidráulico de doble pistón.
- Seguridad mecánica, doble cilindro (A)
- Control remoto (B)
- Capacidad: 1200kg
- Dimensiones del embalaje de madera: 163x88x75 cm
- Peso neto/bruto: 418/460 kg

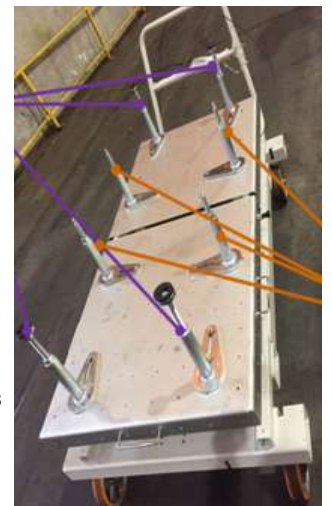
**ACCESSORI A RICHIESTA / OPTIONAL ACCESSORIES (prezzi a richiesta / prices on request)**

Cod. 05.085.27.R1

€ 390,00



- > 8 staffe regolabili in 2 forme
- > 8 support legs (2 forms)
- > 8 soportes ajustables en 2 formas

Tutte le immagini dei prodotti pubblicate in questo catalogo sono puramente indicative e possono essere cambiate senza preavviso.
All product images published in this catalogue have explanatory purposes and can be changed with no warning.

Prezzi promozionali / IVA e trasporto non incluso • Promotional prices • Precios promocionales

PROMO 2024

33

Cod. 05.085.16R ■ (rosso/red)
Cod. 05.085.16B ■ (blu/blue)

€ 1.980,00

PIATTAFORMA DI SOLLEVAMENTO IDRAULICA (A DOPPIA FORBICE)

per motori, cambi e pacchi batterie al litio di vetture ibride

HYDRAULIC LIFTING PLATFORM (DOUBLE SCISSOR LIFT)

for engines, gear boxes and lithium battery packs of hybrid cars

PLATAFORMA ELEVADORA HIDRÁULICA (ELEVADOR DE DOBLE TIJERA)

para motores, cajas de cambios y paquetes de baterías de litio de automóviles híbridos



- Max. altezza: 180 cm
- Min. altezza: 50 cm
- Range sollevamento: 50 ÷ 180 cm
- Dimensioni piattaforma: 130x80x7 cm
- Sfere di scorrimento
- Capacità: 1000 kg
- Ruote in poliuretano con freno e blocco
- Pompa idraulica a pedale
- Dimensioni imballo: 160x90x131 cm
- Peso: 300 kg

- Max. Height: 180 cm
- Min. height: 50 cm
- Lifting range: 50 ÷ 180 cm
- Platform dimensions: 130x80x7 cm
- Scrolling spheres
- Capacity: 1000 kg
- Polyurethane wheels with brake and lock
- Hydraulic foot pump
- Packaging dimensions: 160x90x131cm
- Weight: 300 kg

- Altura máx: 180 cm
- Altura mínima: 50 cm
- Range de elevación: 50 ÷ 180 cm
- Dimensiones de la plataforma: 130x80x7 cm
- Esferas de desplazamiento
- Capacidad: 1000 kg
- Ruedas de poliuretano con freno y cerradura
- Bomba de pie hidráulica
- Dimensiones de embalaje: 160x90x131cm
- Peso: 300 kg



POMPA A PEDALE
FOOT CONTROL PUMP
BOMBA DE PIE



- > Sfere di scorrimento e sponda apribile
- > Rolling spheres and side opening
- > Esferas de desplazamiento y laterales abribles

Tutte le immagini dei prodotti pubblicate in questo catalogo sono puramente indicative e possono essere cambiate senza preavviso.
All product images published in this catalogue have explanatory purposes and can be changed with no warning.

Cod. 05.084.05P

€ 199,⁰⁰NEW!
2024**SOLLEVATORE IDRAULICO DA FOSSA CON COMANDO A PEDALE**

Fornito con supporto a croce a quattro braccia (A)
e supporto inclinabile per allineamento cambi e differenziali (B)

HYDRAULIC TRANSMISSION JACK WITH FOOT CONTROL

Supplied with a 4-arms crosswise support (A)
and adjustable support for the alignment of gearboxes and differentials (B)

GATO HIDRAULICO PARA TRANSMISIONES CON CONTROL DE PEDAL

Se suministra con un soporte de 4 brazos en cruz (A)
y soporte ajustable para la alineación de cajas de cambio y diferenciales (B)

DATI TECNICI:

- Capacità: 500 Kg
- Pompa a pedale
- Valvola limitatrice di carico
- Altezza max : 1990 mm
- Altezza min 1140

TECHNICAL FEATURES:

- Capacity: 500 Kg
- Foot pump
- Overload safety valve
- Max height: 1990mm
- Min. height: 1140mm

DATOS TÉCNICOS:

- Capacidad: 500kgs
- Bomba de pie
- Válvula de seguridad de sobrecarga
- Altura máx.: 1990mm
- Altura mín.: 1140mm

**DOPPIA CULLA
INTERCAMBIABILE
(A + B)**

**INTERCHANGEABLE
DOUBLE CRADLE
(A + B)**

**CUNA DOBLE
INTERCAMBIABILE
(A + B)**

Cod. 05.084.25

€ 94,⁰⁰

**SUPPORTO TELESCOPICO A VITE CON PEDALE
TELESCOPIC MECHANICAL SUPPORT WITH PEDAL
SOPORTE MECANICO TELESCOPICO CON PEDAL**

Ideale per tutti i lavori dove è necessario un sostegno aggiuntivo.

- Lunghezza: min. 1360 - max. 2030 mm
- Capacità massima: 750kgs
- Peso: 18,3 lordi, 15,3 netti
- Dimensioni imballo: 141x37x6,5cm

Ideal for all works when extra support is needed

- Length: min 1360 – max 2030mm
- Max capacity: 750kgs
- Weight: 18,3 gross, 15,3 net
- Packaging dimensions: 141x37x6,5cm

Ideal para todos los trabajos donde se necesita soporte adicional.

- Longitud: min. 1360 - max. 2030mm
- Capacidad máxima: 750kgs
- Peso: 18,3 bruto, 15,3 neto
- Dimensiones del embalaje: 141x37x6,5cm

Cod. 05.085.11

€ 74,⁰⁰

**DISPOSITIVO DI TRASPORTO FUSTI OLIO FINO A 350KGS
DEVICE FOR TRANSPORTING OIL DRUMS UP TO 350KGS
DISPOSITIVO PARA EL TRANSPORTE DE BARRILES DE ACEITE
HASTA 350KGS**



**Per il trasporto facile e sicuro di fusti da 210lt;
è utilizzabile con gru e/o carrelli elevatori da officina**

- Capacità di carico: 350kgs
- Peso netto/lordo: 9,5/11,5kgs
- Dimensioni imballo: 490x260x210mm

**For an easy and safe transportation of 210lt drums;
it can be used with cranes or forklift trucks for mechanic garages**

- Load capacity: 350kgs
- Net/gross weight: 9,5/11,5kgs
- Packing dimensions: 490x260x210mm

**Para un transporte sencillo y seguro de los barriles de 210lt;
puede ser utilizado con grúas o montacargas para talleres mecánicos**

- Capacidad de carga: 350kgs
- Peso bruto/neto: 9,5/11,5kgs
- Dimensiones embalaje: 490x260x210mm

Cod. 05.084.26

€ 236,⁰⁰

CRICCO A CARRELLO 5 T A DOPPIO PISTONE
5 TONS TROLLEY JACK, DOUBLE PISTON
GATO CON RUEDAS 5 T, PISTON DOBLE

Dati tecnici:

- Portata: 5 ton
- Altezza min: 100 mm
- Altezza max: 533 mm
- **Piattello in gomma robusta per proteggere al meglio il veicolo**
- Peso netto: 44 kg
- Dimensioni: 710x310x235 mm

Technical features:

- Capacity: 5 ton
- Min. height: 100 mm
- Max. height: 533 mm
- **Sturdy rubber plate to better protect the vehicle**
- Net weight: 44kg
- Dimensions: 710x310x235 mm

Datos técnicos:

- Capacidad: 5 ton
- Altura min.: 100 mm
- Altura max.: 533 mm
- **Placa de goma resistente para proteger mejor el vehículo**
- Peso neto: 44kg
- Dimensiones: 710x310x235 mm



5t



Cod. 05.084.02L

€ 158,⁰⁰

CRICCO A CARRELLO 3 T A DOPPIO PISTONE
3 TONS TROLLEY JACK WITH DOUBLE PISTONS
GATO CON RUEDAS 3 T, PISTON DOBLE

Dati tecnici:

- Portata: 3 ton
- Altezza min: 80 mm
- Altezza max: 495 mm
- **Piattello in gomma robusta per proteggere al meglio il veicolo**
- Peso netto: 37 kg
- Dimensioni: 640x342x174 mm

Technical features:

- Capacity: 3 ton
- Min. height: 80 mm
- Max. height: 495 mm
- **Sturdy rubber plate to better protect the vehicle**
- Net weight: 37 kg
- Dimensions: 640x342x174 mm

Datos técnicos:

- Capacidad: 3 ton
- Altura min.: 80 mm
- Altura max.: 495 mm
- **Placa de goma resistente para proteger mejor el vehículo**
- Peso neto: 37 kg
- Dimensiones: 640x342x174 mm



3t



CRICCHI A BOTTIGLIA • BOTTLE JACKS • GATOS DE BOTELLA

					
	Cod. 05.084.12	Cod. 05.084.13	Cod. 05.084.14	Cod. 05.084.16	Cod. 05.084.15
↓ Capacità Capacity Capacidad	6 tons	10 tons	16 tons	20 tons	32 tons
Altezza min. Min. height Altura min.	185 mm	200 mm	225 mm	235	280 mm
Alzata Riser Alzamiento	110 mm	125 mm	140 mm	145	180 mm
Regolazione altezza Height adjustment Ajuste altura	60 mm	60 mm	60 mm	60 mm	--
Prezzo promo Promo price	€ 22,00	€ 30,00	€ 41,40	€ 54,00	€ 92,00

Cod. 05.084.07 € 128,00



- Capacità: 20 T
- Altezza min.: 210 mm
- Altezza max.: 340 mm
- Alzata max.: 130 mm
- Range pressione aria 0,8 – 0,95Mpa
- Dimensione del piano di appoggio: 165 x 224 mm
- Dim. Imballo: 260 x 210 x 230 mm
- Peso netto/lordo: 13,5/13,9 kg

- Capacity: 20 T
- Min. height: 210 mm
- Max. height: 340 mm
- Lifting altitude: 130 mm
- Air Pressure Range: 0,8 – 0,95Mpa
- Base size: 165 x 224 mm
- Packaging dim.: 260 x 210 x 230 mm
- Net/gross weight: 13,5/13,9 kgs

CRICCO A BOTTIGLIA A COMANDO PNEUMATICO

Ideale come kit soccorso per autocarri.

Può essere usato anche manualmente con leva

PNEUMATIC BOTTLE JACK

Ideal as aid kit for trucks, it may be used also by hand with a lever

GATO DE BOTELLA CON FUNCIONAMIENTO NEUMÁTICO

Ideal como kit de ayuda para camiones, puede ser utilizado también por mano con una palanca

Cod. 05.084.17 € 185,00

- Capacità: 35 T
- Altezza min.: 250 mm
- Altezza max.: 408 mm
- Alzata max.: 160 mm
- Range pressione aria 0,8 – 1 Mpa
- Dimensione del piano di appoggio: 150 x 226 mm
- Dim. Imballo: 230x290x280mm
- Peso netto/lordo: 21/22 kg

35 T

- Capacity: 35 T
- Min. height: 250 mm
- Max. height: 408 mm
- Lifting altitude: 160 mm
- Base size: 150 x 226 mm
- Air Pressure Range: 0,8 – 1 Mpa
- Packaging dim.: 230x290x280mm
- Net/gross weight: 21/22 kgs

Cod. 05.085.01 € 28,00

 COPPIA DI CAVALLETTI DA 3T
 COUPLE OF 3T JACK STANDS
 GATOS DE 3T

- Altezza/height/altura max: 428 mm
- Altezza/height/altura min: 298 mm
- Peso/weight: 7,5 kgs



3 T



Cod. 05.085.00 € 44,00

 COPPIA DI CAVALLETTI DA 6T
 COUPLE OF 6T JACK STANDS
 GATOS DE 6T

- Altezza/height/altura max: 610 mm
- Altezza/height/altura min: 400 mm
- Peso/weight: 14,6 kgs



6 T

Tutte le immagini dei prodotti pubblicate in questo catalogo sono puramente indicative e possono essere cambiate senza preavviso.
 All product images published in this catalogue have explanatory purposes and can be changed with no warning.

Prezzi promozionali / IVA e trasporto non incluso • Promotional prices • Precios promocionales

PROMO 2024

37

AVVIATORI D'EMERGENZA • JUMP STARTERS • ARRANCADOR DE EMERGENCIA

CLASSIC LINE



F3000 12V



HAPPY TIR 12/24V



HAPPY VAN 12V



HAPPY TANK 12/24V

SMART LINE



HAPPY TANK 2 12/24V



HAPPY VAN 2 12V



F4000-2 12/24V

BUDGET LINE



BOCIA EVO 12V



BOCIA EVO 12/24V



HAPPY TRACTOR EVO 12V

Tutte le immagini dei prodotti pubblicate in questo catalogo sono puramente indicative e possono essere cambiate senza preavviso.
All product images published in this catalogue have explanatory purposes and can be changed with no warning.

AVVIATORI D'EMERGENZA • JUMP STARTERS • ARRANCADOR DE EMERGENCIA

CLASSIC LINE • TRADITIONAL AGM POWER PACK

Cod. 03.015.00

€ **267,00**

F3000 12V



MADE IN ITALY

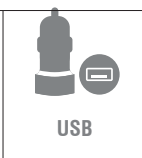
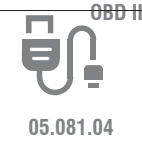
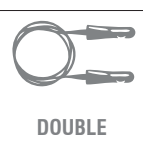
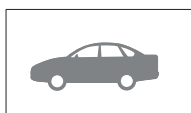
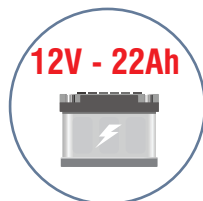

Cod. 03.016.00

€ **419,00**

HAPPY VAN 12V



MADE IN ITALY

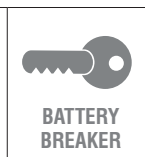
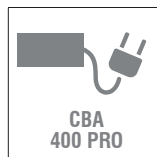
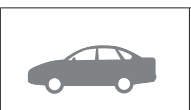
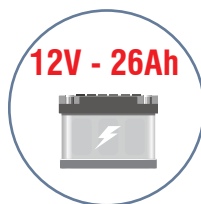

Tutte le immagini dei prodotti pubblicate in questo catalogo sono puramente indicative e possono essere cambiate senza preavviso.
All product images published in this catalogue have explanatory purposes and can be changed with no warning.

Cod. 03.018.01

€ 949,⁰⁰

HAPPY TIR 12/24V



MADE IN ITALY

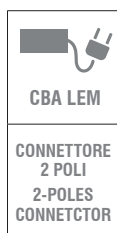
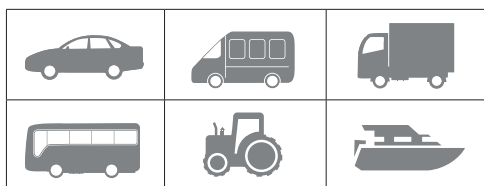
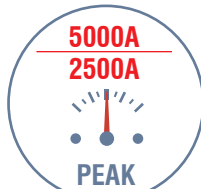

Cod. 05.088.03

€ 34,⁰⁰

Carrello/Trolley

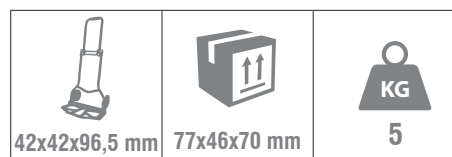

Cod. 03.019.01

€ 1.115,⁰⁰

HAPPY TANK PLUS 12/24V



MADE IN ITALY

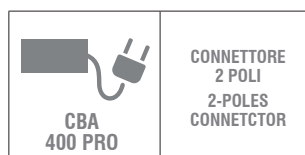
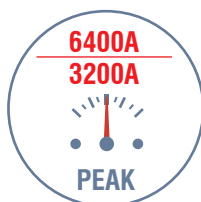
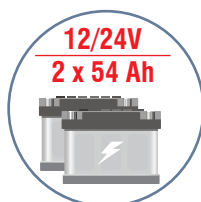

Tutte le immagini dei prodotti pubblicate in questo catalogo sono puramente indicative e possono essere cambiate senza preavviso.
All product images published in this catalogue have explanatory purposes and can be changed with no warning.

AVVIATORI D'EMERGENZA • JUMP STARTERS • ARRANCADOR DE EMERGENCIA

SMART PACK LINE

Cod. 03.015.11

€ **592,00**

F4000-2 12/24V

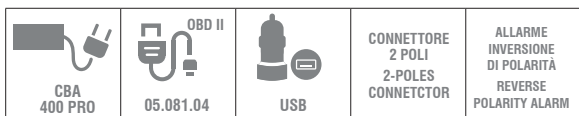
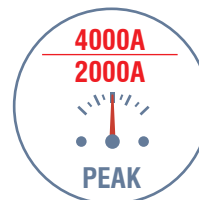
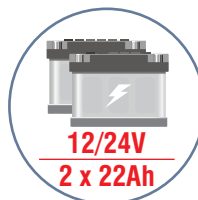

Cod. 03.016.02

€ **338,00**

HAPPY VAN 2 12V

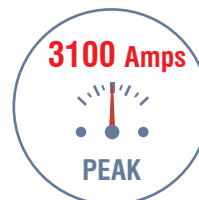
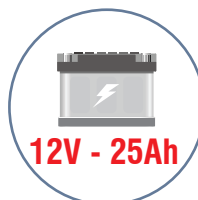

Cod. 05.081.04

€ **18,00**

OBD II

CAVO OBD II Presa accendisigari per booster (solo 12V)

OBD II CABLE cigarette lighter socket for booster (only 12V)



Cod. 05.081.05

€ **18,00**

OBD

CAVO OBD

OBD CABLE



AVVIATORE D'EMERGENZA • JUMP STARTER • ARRANCADOR DE EMERGENCIA

SMART PACK LINE

Cod. 03.019.02

€ 1.082,00 **HAPPY TANK 12/24V**

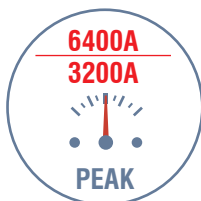
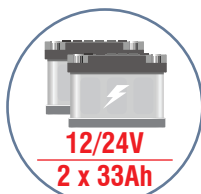

• **VOLTMETRO DIGITALE (1)**

Questo display consente ai professionisti di vedere rapidamente la tensione disponibile e di testare l'alternatore di un veicolo

• **INTERRUTTORE 12-24V (2)**

Questo interruttore facile da usare consente di cambiare il booster da 12 a 24 V

• **ALLARME DI INVERSIONE DI POLARITÀ (3)**

Questo avviso acustico e visivo informa l'operatore dell'errato collegamento dei terminali

- Diametro cavo (mm²): 50
- Lunghezza cavo (cm): 175
- Dimensione (cm): 39 x 27 x 53
- Peso: 33 kg

• **DIGITAL VOLTMETER**

This display allows professionals to quickly see the voltage available and to test the alternator of a vehicle

• **12-24V SWITCH**

This easy to use switch allows the booster to be changed from 12 to 24V.

• **REVERSE POLARITY ALARM**

This audible and visual alert informs professionals of incorrect terminal connections

- Cable Diameter (mm²): 50
- Cable length (cm): 175
- Dimensions (cm): 39x27x53
- Weight: 33 kg

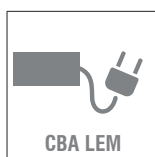
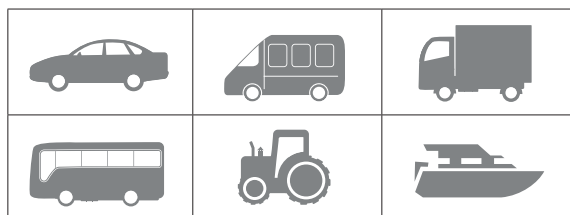

Tutte le immagini dei prodotti pubblicate in questo catalogo sono puramente indicative e possono essere cambiate senza preavviso.
All product images published in this catalogue have explanatory purposes and can be changed with no warning.

AVVIATORI D'EMERGENZA • JUMP STARTERS • ARRANCADOR DE EMERGENCIA

BUDGET LINE

BUDGET

Cod. 03.015.03

€ 188,⁰⁰

BOCIA EVO 12V

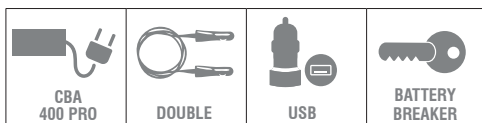
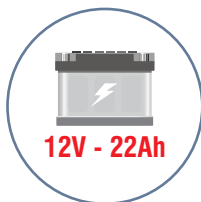

- Pinze con contatto in bronzo con treccia interna
- Controllo stato di carica (sotto carica)
- Controllo stato di carica (a riposo)
- Stacca batteria con allarme polarità invertita
- Carica batterie 1 Amp 100/240V idoneo per la ricarica dell'avviatore (non adatto per la ricarica della batteria dell'autovettura)
- **Nuova batteria 12V 22Ah / 2000A peak**

- Pliers with bronze contact and internal braid
- Charge indicator (under charge)
- Charge indicator (not under charge)
- Battery switch with reverse polarity alarm
- Battery charger 1 Amp 100/240V for recharging the booster (not suitable for recharging the car battery)
- **New battery 12V 22Ah / 2000A Peak**

Cod. 03.017.01

€ 328,⁰⁰

HAPPY TRACTOR EVO 12V

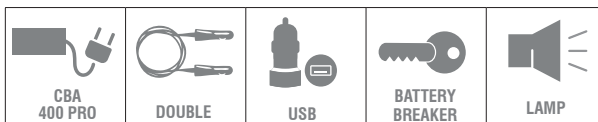
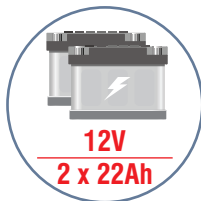

- Voltmetro
- Stacca batteria
- Luce a led di emergenza
- Pinze con contatto in bronzo con treccia interna
- Caricabatteria 4 Amp 100/240V idoneo per la ricarica dell'avviatore (non adatto per la ricarica della batteria dell'autovettura)
- **Nuove batterie 2pzx12V 22Ah / 4000A Picco - 12V**

- Voltmeter
- Battery switch
- Emergency led light
- Pliers with bronze contact and internal braid
- Battery charger 4 Amp 100/240V for recharging the booster (not suitable for recharging the car battery)
- **New batteries 2pcs x 12V 22Ah / 4000A Peak - 12V**

Cod. 03.015.04

€ 353,⁰⁰

BOCIA EVO 12/24V

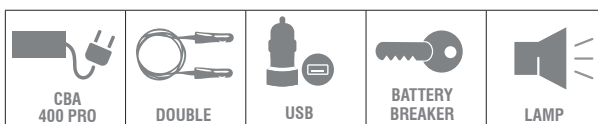
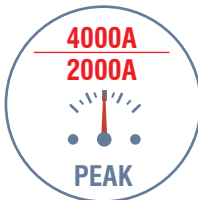
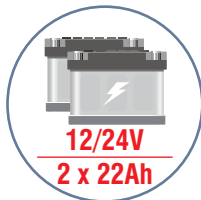

- Voltmetro
- Stacca batteria
- Luce a led di emergenza
- Pinze con contatto in bronzo con treccia interna
- Caricabatteria 4 Amp 100/240V, idoneo per la ricarica dell'avviatore (non adatto per la ricarica della batteria dell'autovettura)
- Commutatore 12V-0-24V
- **Nuove batterie 2pz x 12 V 22Ah/ 4000A Picco - 12V, 2000A Picco - 24V**

- Voltmeter
- Battery switch
- Emergency led light
- Pliers with bronze contact and internal braid
- Battery charger 4 Amp 100/240V for recharging the booster (not suitable for recharging the car battery)
- Switch 12V-0-24
- **New batteries 2pcs x 12V 22Ah/ 4000A Peak - 12V, 2000A Peak - 24V**

Tutte le immagini dei prodotti pubblicate in questo catalogo sono puramente indicative e possono essere cambiate senza preavviso.
All product images published in this catalogue have explanatory purposes and can be changed with no warning.

Prezzi promozionali / IVA e trasporto non incluso • Promotional prices • Precios promocionales

PROMO 2024

43

PROMO 2024

										
	CLASSIC LINE				SMART LINE			BUDGET LINE		
Corredo standard Standard outfits	F3000	HAPPY VAN	HAPPY TIR	HAPPY TANK PLUS	HAPPY VAN 2	F4000-2	HAPPY TANK 2	BOCIA EVO	HAPPY TRACTOR EVO	BOCIA EVO
Cod./Code	03.015.00	03.016.00	03.018.01	03.019.01	03.016.02	03.015.11	03.019.02	03.015.03	03.017.01	03.015.04
Voltaggio/ Voltage	12V	12V	12/24V	12/24V	12V	12/24V	12/24V	12V	12V	12/24V
Capacità batterie (Ampere/picco) Battery capacity (Ampere/Peak)	22Ah 2000A	26Ah 2500A	2x26Ah 5000 / 2500A	2x54Ah 6400 / 3200A	25Ah 3100A	2x22Ah 4000 / 2000A	2x33Ah 6400 / 3200A	22Ah 2000A	2x22Ah 4000A	2x22Ah 4000 / 2000A
Allarme elettronico contro inversione di polarità Electronic alarm to avoid polarity inversion	—	—	—	—	✓	✓	✓	✓	✓	✓
Protezione circuito di carica Charging circuit protection	✓	✓	✓	✓	✓	✓	✓	✓	✓	✓
Presa accendisigari Cigarette lighter socket	✓	✓	—	—	✓	✓	✓	✓	✓	✓
Lunghezza cavi Cable section	150 mm	150mm	200 mm	150mm	120 mm	150 mm	180 mm	100 mm	150 mm	150 mm
Sezione cavi Cable section	25 mm ²	25 mm ²	50 mm ²	50 mm ²	35 mm ²	50 mm ²	50 mm ²	25 mm ²	25 mm ²	25 mm ²
Voltmetro/Voltmeter	led	led	digit	digit	led	digit	digit	led	analog	analog
Presa USB /socket	✓	✓	—	—	✓	✓	✓	✓	✓	✓
Cavo doppio accendisigari Double cig. lighter Cod. 03.024.35	✓	✓	—	—	✓	✓	✓	✓	✓	✓
Cavo OBDII con presa accendisigari OBDII with cig. lighter socket Cod. 05.081.04	✓	✓	—	—	✓	✓	✓	option	option	option
Caricabatterie Battery charger	03.024.34B CBA 400 PRO 	03.024.34B CBA 400 PRO 	03.024.36B CBA LEM 7Amp 	03.024.36B CBA LEM 7Amp 	03.016.02.R1 	03.015.11.R2 	03.015.11.R2 	03.015.03.R1 	03.015.04.R1 	03.015.04.R1 
Dimensioni, cm / peso, kg	27x19x25 11,5kg	--x--x-- 18kg	43x52x48 34kg	--x--x-- 50kg	34x24x48 14kg	32x33x48 26 kg	45x30x65 35 kg	41x17x41 11 kg	47x30x45 20 kg	47x30x45 20 kg
Prezzo promo: Promo price:	€ 267, ⁰⁰	€ 419, ⁰⁰	€ 949, ⁰⁰	€ 1.115, ⁰⁰	€ 338, ⁰⁰	€ 592, ⁰⁰	€ 1.082, ⁰⁰	€ 188, ⁰⁰	€ 328, ⁰⁰	€ 353, ⁰⁰

PINZE PROFESSIONALI 1000A isolate per batterie auto/camion
PROFESSIONAL PLIERS 1000A insulated for batteries of cars and trucks

Cod. 05.100.00 > Pinza nera
> Black plier
€ 11,⁰⁰

Cod. 05.100.01 > Pinza rossa
> Red plier
€ 11,⁰⁰

- Completamente isolata
- Terminali in bronzo (maggiore superficie di contatto sul polo batteria)
- Ampia apertura: max. 35mm
- Treccia in rame
- Minimo ingombro

- Fully insulated
- Terminals of bronze (bigger contact surface on the battery pole)
- Great opening: max. 35mm
- Copper braid
- Space-saving



Tutte le immagini dei prodotti pubblicate in questo catalogo sono puramente indicative e possono essere cambiate senza preavviso.
All product images published in this catalogue have explanatory purposes and can be changed with no warning.



EV CHARGING POINT
STAZIONI DI RICARICA DA PARETE PER VETTURE ELETTRICHE
WALL CHARGING STATIONS FOR ELECTRIC VEHICLES

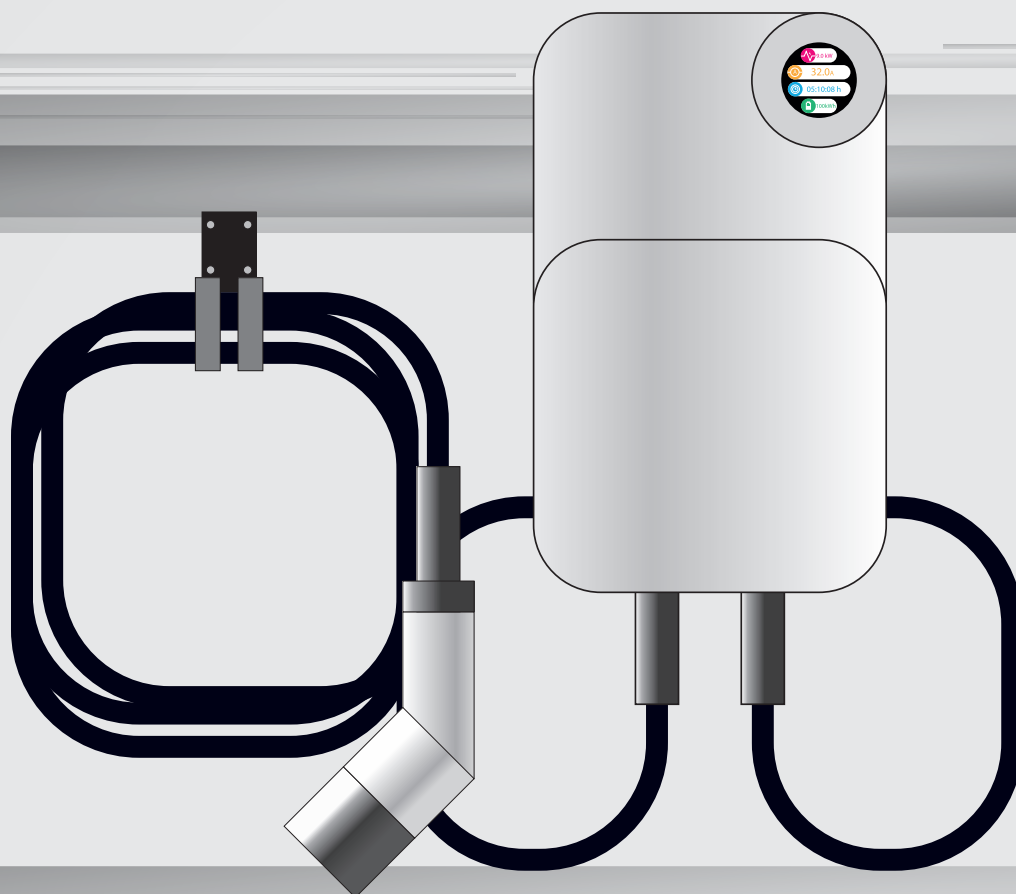

Tutte le immagini dei prodotti pubblicate in questo catalogo sono puramente illustrative e possono essere cambiate senza preavviso.
All product images published in this catalogue have a purely illustrative nature and can be changed without notice.

STAZIONI DI RICARICA DA PARETE PER VETTURE ELETTRICHE
WALL CHARGING STATIONS FOR ELECTRIC VEHICLES
ESTACIONES DE RECARGA DE PARED PARA VEHÍCULOS ELÉCTRICOS

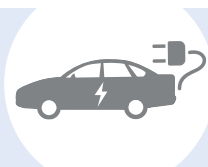

Cod. 03.024.40 € **650,00**

11 kW / 16A

			11Kw 3 PH	16A
--	--	--	--------------	-----

Cod. 03.024.41 € **700,00**

22 kW / 32A

			22Kw 3 PH	32A
--	--	--	--------------	-----



- Alimentazione: 230 V/400 V AC (trifase)
- Frequenza: 50 Hz/60 Hz
- Max . potenza di uscita: 11kW/22kW (trifase)
- Max . corrente: 16A/32A
- Lunghezza cavo: 6 m
- Dimensioni: 43x25.5x26cm (11kW) / 69x35x15.5cm (22 kW)
- Dimensioni imballo: 53x44.5x55.5cm (11 kW) / 71x72x34.5cm (22 kW)

- Power supply: 230V/400V AC (three-phase)
- Frequency: 50Hz/60Hz
- Max. output power: 11kW/22kW (three-phase)
- Max. current: 16A/32A
- Cable length: 6mt
- Dimensions: 43x25.5x26cm (11kW) / 69x35x15.5cm (22 kW)
- Packaging dimensions: 53x44.5x55.5cm (11 kW) / 71x72x34.5cm (22 kW)

- Alimentación: 230V/400V AC (trifásica)
- Frecuencia: 50Hz/60Hz
- Potencia de salida máx.: 11kW/22kW (trifásica)
- Corriente máx.: 16A/32A
- Longitud del cable: 6mt
- Dimensiones: 43x25,5x26cm (11kW) / 69x35x15,5cm (22kW)
- Dimensiones del embalaje: 53x44,5x55,5cm (11 kW) / 71x72x34,5cm (22 kW)

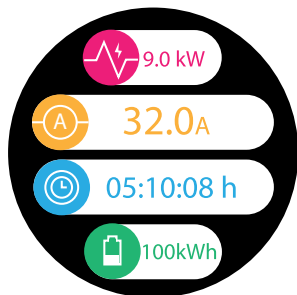
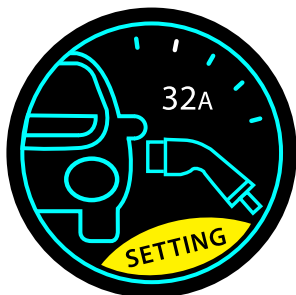

IP66



EV TYPE 2



Leakage Protection

Tutte le immagini dei prodotti pubblicate in questo catalogo sono puramente indicative e possono essere cambiate senza preavviso.
All product images published in this catalogue have explanatory purposes and can be changed with no warning.

EV CHARGING POINT

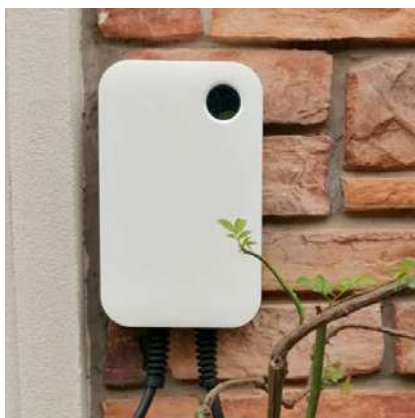

- Adatto per i parcheggi di aree residenziali, centri commerciali e uffici
- Facile da installare, stabile nelle prestazioni
- Schermo touch screen a colori LCD è in grado di mostrare lo stato di carica dettagliato
- Indicatore luminoso a LED
- Regolazione intelligente della potenza
- Protezione da sovratensione
- Protezione da sottotensione
- Protezione da sovraccarico
- Protezione da cortocircuito
- Protezione isolamento
- Messa a terra
- Protezione da sovratemperatura
- Protezione contro i fulmini

- Suitable for the parking lots of residential areas, shopping malls and office places
- Easy to install, stable in performance
- The LCD colour touch screen is able to show the detailed charging status
- LED Indicator light
- Intelligent power adjustment
- Over-voltage protection
- Under-voltage protection
- Overload protection
- Short circuit protection
- Leakage Protection
- Ground protection
- Overtemperature protection
- Lightning protection

- Adecuado para aparcamientos de áreas residenciales, centros comerciales y oficinas
- Fácil de instalar, estable en rendimiento
- La pantalla táctil LCD en colores puede mostrar el estado de carga detallado
- Luz indicadora LED
- Ajuste de potencia inteligente
- Protección contra sobrevoltaje
- Protección contra subtension
- Protección contra sobrecarga
- Protección contra cortocircuitos
- Protección contra fugas
- Puesta a tierra
- Protección contra sobrettemperatura
- Protección contra rayos

Cod. 03.024.38

€ 269,00

CARICABATTERIE PORTATILE MODALITÀ 2 EV (10/13/16A 1 FASE 3,6KW) CON CONNETTORE TIPO 2 DA 5 M

MODE 2 EV CHARGING CABLE (10/13/16A 1 PHASE 3.6KW) WITH 16FT/5M TYPE 2 CONNECTOR



Questo caricabatteria è particolarmente utilizzato per la ricarica lenta di veicoli elettrici, dotati di attacco "plug in" di tipo 2 alla presa di casa.

This battery charger is particularly used for electric vehicle charging, equipped with a Type 2 plug, suitable for the household socket.

- Alimentazione/Tensione: 230V ± 10% AC Monofase
- Corrente/Frequenza: 16A 50/60Hz
- Spina: SCHUKO/CEE/UK/NEMA/NZ
- Corrente nominale: 10/13/16 A commutabile
- Potenza nominale: max. 3,6 KW
- Connettore: tipo 2
- Lunghezza cavo: 5 m
- Indicatore a LED
- Grado di protezione: IP66
- Protezione dagli urti: IK10

• Valigia di trasporto inclusa

Protezione elettrica:

- Protezione da sovracorrente
- Protezione da corrente residua
- Protezione di messa a terra
- Protezione da sovra/sottotensione
- Protezione da sovra/sotto frequenza
- Protezione da sovra/sottotemperatura
- Certificazione: EN62752
- Temperatura: da -30°C a +50°C
- Umidità: 5%-95%
- Altitudine: <2000 m
- Peso netto/peso lordo: 2,5 kg/ 2,8 kg

- Power Supply/Voltage: 230V ± 10% AC Single phase
- Current/ Frequency: 16A 50/60Hz
- Plug: SCHUKO/CEE/UK/NEMA/NZ
- Rated Current: 10/13/16A Switchable
- Rated Power: Max. 3.6KW
- Connector: Type 2
- Cable Length: 5m
- LED Indicator Light
- Protection degree: IP66
- Impact Protection: IK10

• Transport case included

Electrical Protection:

- Over current protection
- Residual current protection
- Ground protection
- Over/Under voltage protection
- Over/Under frequency protection
- Over/Under temperature protection
- Certification standard: EN62752
- Temperature range: -30°C to +50°C
- Humidity range: 5%-95%
- Altitude range: <2000m
- Net Weight/ Gross Weight: 2.5kg/ 2.8kg

Tutte le immagini dei prodotti pubblicate in questo catalogo sono puramente indicative e possono essere cambiate senza preavviso.
All product images published in this catalogue have explanatory purposes and can be changed with no warning.

Cod. 03.036.37

€ 269,00

**UNITÀ DI ASPIRAZIONE OLIO MOTORE**

pneumatica, carrellata, con sonde di aspirazione, connettore di raccolta sottoponte, completo di pre-camera

MOTOR OIL SUCTION UNIT

Pneumatic, on trolley, with suction probes, under bridge connector for collection, complete with pre-chamber

- Serbatoio: 90 lt
- Pre-camera graduata: 10lt
- Pressione di lavoro: 8÷10 bar
- Pressione aria per scarico olio: 1÷2 bar
- Dimensioni: 400x400x1300mm
- Peso: 35 kg

- Tank: 90 lt
- Graduated pre-chamber: 10lt
- Working pressure: 8÷10 bar
- Air pressure for oil discharge: 1÷2 bar
- Dimensions: 400x400x1300mm
- Weight: 35 kg

Cod. 03.036.26

€ 119,00

**SCARICATORE PER OLIO ESAUSTO
WASTE OIL DRAINER**

- Capacità serbatoio: 70 lt
- Capacità imbuto: 10 lt
- Altezza: 1,65 mt
- Alimentazione: aria compressa
- Pressione max per scarico olio: 1 bar
- Dimensioni imballo: 50 x 44 x 96 cm

- Tank capacity: 70 lt
- Funnel capacity: 10 lt
- Height: 1.65 mt
- Powered by compressed air
- Max. oil drain pressure: 1 bar
- Packaging dimensions: 50 x 44 x 96 cm

Cod. 03.036.01

€ 1.141,00

**RECUPERATORE CARBURANTI (BENZINA/GASOLIO) 90 LT
90 LT FUEL (PETROL/DIESEL) RECOVERY DEVICE
RECUPERADOR DE COMBUSTIBLES (GASOLINA/GASÓLEO), 90 LT**

- Capacità: 90lt
- Serbatoio carrellato in acciaio inox
- Funzionamento con sistema Venturi (A)
- Aspira e scarica il carburante in pochi minuti
- Dispositivo per recupero vapori (B)
- Dimensioni: 530x530x1100mm
- Peso 28.3 kg

- Capacity: 90lt
- 90lt Stainlesssteel tank with trolley
- Functioning with Venturi system (A)
- It drains and discharges the fuel in a few minutes
- Device to recover vapours (B)
- Dimensions: 530x530x1100mm
- Weight: 28.3 kg



Tutte le immagini dei prodotti pubblicate in questo catalogo sono puramente indicative e possono essere cambiate senza preavviso.
All product images published in this catalogue have explanatory purposes and can be changed with no warning.

Prezzi promozionali / IVA e trasporto non incluso • Promotional prices • Precios promocionales

PROMO 2024

49

PRESSA PNEUMO-IDRAULICA DA 30 TON
30 TONS AIR HYDRAULIC PRESS

Cod. 03.031.32LT

€ **764,00**

PRESSA PNEUMO-IDRAULICA DA 30 TON

per officine meccaniche auto, moto, macchine agricole,
manutenzione industriale

30 TONS AIR HYDRAULIC PRESS

for mechanical workshops for auto, moto, agricultural machines,
industrial maintenance

- Capacità: 30 tonnellate
- Corsa pistone: 160mm
- Avanzamento max 6 mm a colpo
- Velocità di discesa <30mm/s
- Min. distanza operativa: 130mm
- Max. distanza operativa: 820mm
- Pompa pneumo-idraulica, con comando anche manuale
- Pistone mobile
- **A:** Coppia piastre in acciaio con intaglio a "V"
- Dimensioni imballo: 1750x380x270mm (pressa smontata)
- Peso netto/lordo: 150/160kg
- Dimensioni pressa montata: 590x770x1760mm
- Capacity: 30 tons
- Piston stroke: 160mm
- Feed max 6 mm per stroke
- Descent speed <30mm/s
- Min. working distance: 130mm
- Max. working distance: 820mm
- Air hydraulic pump, with handle
- Moving piston
- **A:** Pair of steel plates with V-carving
- Package dimensions: 1750x380x270mm (pressa smontata)
- Net/gross weight: 150/160kg
- Dim. assembled press: 590x770x1760mm

I particolari che fanno la differenza

B: Pistone mobile, manometro incassato nel corpo della macchina

C: Pompa pneumo-idraulica e comando manuale con leva

The details that make the difference

B: Mobile piston, pressure gauge built-in in the body of the machine

C: Air hydraulic pump and manual control with lever

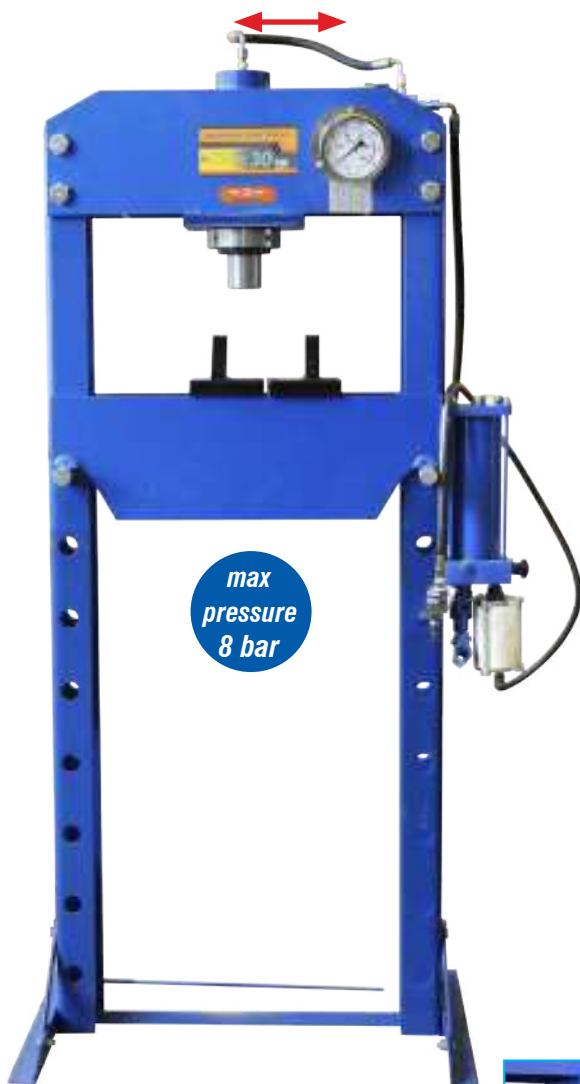

max
pressure
8 bar

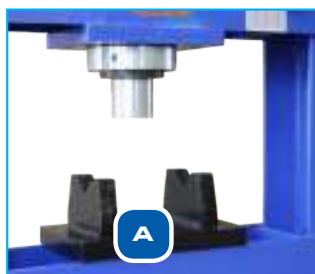

CORREDO A RICHIESTA • OPTIONAL EQUIPMENT • BAJO PEDIDO

Cod. 03.031.33

€ **190,00**

SET PUNZONI E PIASTRA X PRESSA 30T
SET PUNCHES AND PLATE X PRESS 30T

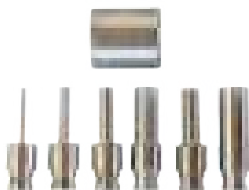

SERIE DI 6 PUNZONI IN ACCIAIO C40
per estrazione cuscinetti/boccole

SET OF 6 PUNCHES IN C40 STEEL
for removing bearings/bushings



PIASTRONE
per smontaggio cuscinetti/boccole

LARGE PLATE
for removing bearings/bushings



FLANGE ESTRATTRICI
2 coppie: Ø35-50mm / Ø50-75mm

EXTRACTING FLANGES
2 pairs: Ø35-50mm / Ø50-75mm

Cod. 03.031.36

€ **26,00**

COMANDO A PEDALE PER PRESSA 30T
FOOT CONTROL FOR 30T PRESS



Tutte le immagini dei prodotti pubblicate in questo catalogo sono puramente indicative e possono essere cambiate senza preavviso.
All product images published in this catalogue have explanatory purposes and can be changed with no warning.

PRESSA PNEUMO-IDRAULICA DA 50 TON 50 TONS AIR HYDRAULIC PRESS

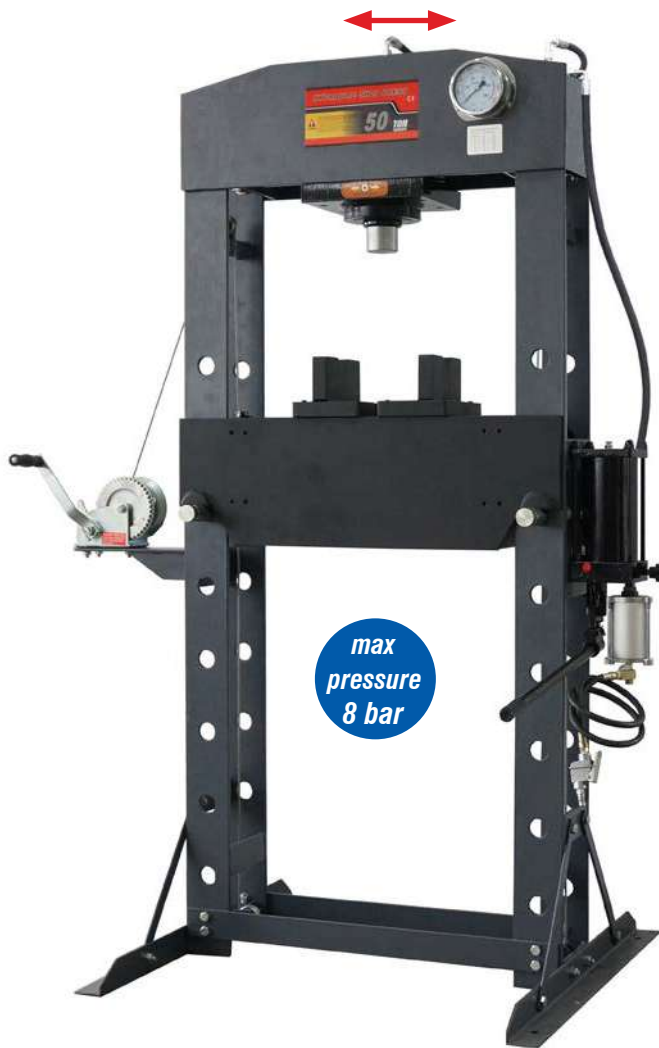

Cod. 03.031.37

€ 1.295,00

PRESSA PNEUMO-IDRAULICA DA 50 TON

per officine meccaniche auto, moto, macchine agricole, manutenzione industriale

50 TONS AIR HYDRAULIC PRESS

for mechanical workshops for auto, moto, agricultural machines, industrial maintenance

- Capacità: 50 ton
- Corsa pistone: 180mm
- Avanzamento max 6 mm a colpo
- Min. distanza operativa: 280 mm
- Max. distanza operativa: 1100 mm
- Pompa pneumo-idraulica, con comando anche manuale (pedale a richiesta)
- Pistone mobile
- **A:** Coppia piastre in acciaio con intaglio a "V"
- Dimensioni imballo: 1980x880x360 mm (pressa smontata)
- Peso netto/lordo: 241/261 kg
- Capacity: 50 tons
- Piston stroke: 180mm
- Feed max 6 mm per stroke
- Min. working distance: 280 mm
- Max. working distance: 1100 mm
- Air hydraulic pump, with handle (pedal on demand)
- Moving piston
- **A:** Pair of steel plates with V-carving
- Package dimensions: 1980x880x360 mm (pressa smontata)
- Net/gross weight: 241/261 kg

I particolari che fanno la differenza

- B:** Pistone mobile, manometro incassato nel corpo della macchina
- C:** Pompa pneumo-idraulica e comando manuale con leva

The details that make the difference

- B:** Mobile piston, pressure gauge built-in in the body of the machine
- C:** Air hydraulic pump and manual control with lever

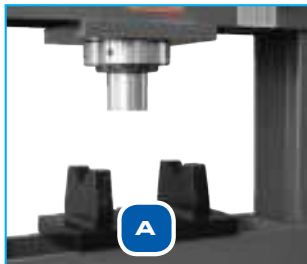

CORREDO A RICHIESTA • OPTIONAL EQUIPMENT • BAJO PEDIDO

Cod. 03.031.40

€ 198,00

SET PUNZONI E PIASTRA X PRESSA 50T
SET PUNCHES AND PLATE X PRESS 50T



Serie di 6 punzoni in acciaio C40 per estrazione cuscinetti/boccole
Set of 6 punches in C40 steel for removing bearings/bushings



Piastrone per smontaggio cuscinetti/boccole
Large plate for removing bearings/bushings



Flange estraibili
2 coppie: Ø35-50mm / Ø50-75mm
Extracting flanges
2 pairs: Ø35-50mm / Ø50-75mm

Cod. 03.031.36

€ 26,00

COMANDO A PEDALE PER PRESSA 50T
FOOT CONTROL FOR 50T PRESS



Tutte le immagini dei prodotti pubblicate in questo catalogo sono puramente indicative e possono essere cambiate senza preavviso.
All product images published in this catalogue have explanatory purposes and can be changed with no warning.

Prezzi promozionali / IVA e trasporto non incluso • Promotional prices • Precios promocionales

PROMO 2024

51

Cod. 05.084.04

€ 84,00

CAPRETTA SOLLEVAMENTO MOTORI
ENGINE LIFTING CRANE
SOPORTE DE ELEVACIÓN DEL MOTOR



- Portata: 500kgs
- Capacity: 500kgs
- Capacidad: 500kgs
- Agganci regolabili:
- Supports adjustment:
- Ajuste apoyos:
- 1100 ÷ 1600mm
- 1100 ÷ 1600mm
- 1100 ÷ 1600mm
- Peso: 22kgs
- Weight: 22kgs
- Peso: 22kgs

Cod. 05.085.08COMBI

€ 260,00

GRU SMONTABILE DA OFFICINA
DISMOUNTABLE CRANE FOR MECHANIC WORKSHOPS
GRUA DESMONTABLE PARA TALLER MECANICO



- Capacità: 1 ton
- Misure: 1620mmx930x1600hmm
- Dimensioni imballo: 800x860x1600mm
- Peso: 76kgs
- **Particolarità: pistone a doppio effetto, include traversa con catene e traslatore cod. 05.085.13**

- Capacity: 1 ton
- Measures: 1620mmx930x1600hmm
- Dimensions (packed): 800x860x1600mm
- Weight: 76kgs
- **Special feature: double effect piston, includes the lifting bar with chains and side-shift system cod. 05.085.13**

- Capacidad: 1 ton
- Medidas: 1620mmx930x1600mm
- Dimensiones embalaje: 800x860x1600mm
- Weight: 76kgs
- **Special feature: double effect piston, includes the lifting bar with chains and side-shift system cod. 05.085.13**

Cod. 05.085.13

€ 30,00



Traversa sollevamento motori con catene e traslatore
Motor lifting bar with chains and side-shift system
Barra de elevación para motor con cadenas y sistema de movimiento lateral

Cod. 05.085.12

€ 176,00

CAVALLETTO SOSTEGNO MOTORE
ENGINE SUPPORT STAND
SOPORTE FRONTAL PARA MOTORES



- Capacità = 550 kg
- Equipaggiato con 6 ruote
- Altezza dal suolo: 80 cm
- Piatto di fissaggio: 250x150x12 mm
- Peso: 36 kg
- Load capacity = 550 kg
- 6 wheels for maximum stability
- Height from the floor: 80 cm
- Fixing plate: 250x150x12 mm
- Weight: 36 kg
- Capacidad de carga = 550 kg
- 6 ruedas para máxima estabilidad
- Altura desde el suelo: 80 cm
- Placa de fijación: 250x150x12 mm
- Peso: 36 kg

Tutte le immagini dei prodotti pubblicate in questo catalogo sono puramente indicative e possono essere cambiate senza preavviso.
All product images published in this catalogue have explanatory purposes and can be changed with no warning.

Cod. 05.083.05

€ 15,⁵⁰NEW!
2024**MATERASSINO PIEGHEVOLE PER LAVORO SOTTO SCOCCA
FOLDABLE MECHANIC PROTECTIVE MAT**PERSONALIZZAZIONE INCLUSA PER MINIMO DI QUANTITÀ (100 PZ)
CUSTOMIZATION INCLUDED FOR MINIMUM QUANTITY (100 PCS)

- Size: 1200*400*23mm
 - Insulating thanks to 3-layer soft material
 - Moisture and dirt repellent
- Guarantees health-conscious working in the lower area of vehicles on a flat surface
- Work wear and knees stay dry, clean and do not cool out

- Size: 1200*400*23mm
- Isolamento grazie al materiale morbido a 3 strati
- Resistente all'umidità e allo sporco
- Garantisce l'igiene durante il lavoro nella parte inferiore dei veicoli
- L'abbigliamento da lavoro e le ginocchia rimangono asciutte, pulite e non si raffreddano

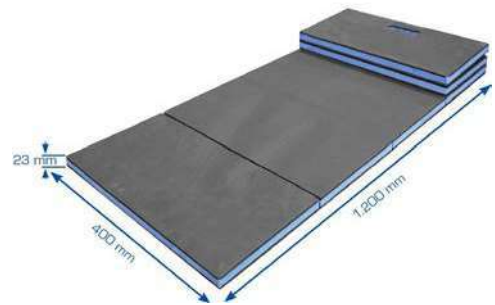

Cod. 05.083.06

€ 39,⁸⁰NEW!
2024**PANCA DI LAVORO SOTTO CRUSCOTTO
UNDER DASH CREEPER**

- Regolabile da 520 mm a 680 mm
- Idoneo per auto, camion e SUV
- Tubo in acciaio 20x20x1,8mm/25x25x1,8mm
- Dimensioni del polywood: 258x998x18mm
- Spessore schiuma EPE 30 mm
- Capacità di peso: 150 kg

- Adjustable from 520mm to 680mm
- Suitable for cars, trucks and SUV
- Steel tube 20x20x1.8mm/25x25x1.8mm
- Polywood size: 258x998x18mm
- EPE Foam thickness: 30 mm
- Weight capacity: 150kgs



Tutte le immagini dei prodotti pubblicate in questo catalogo sono puramente indicative e possono essere cambiate senza preavviso.
All product images published in this catalogue have explanatory purposes and can be changed with no warning.

Prezzi promozionali / IVA e trasporto non incluso • Promotional prices • Precios promocionales

PROMO 2024

53

Cod. 05.083.00 € **38,00**

**SDRAIOTTO SOTTO MACCHINA
HEAVY DUTY CREEPER**



- Cuscino poggiatesta regolabile per il massimo comfort di lavoro
- 6 ruote piroettanti in gomma antiolio
- Misure: 102x43x18 cm
- Adjustable pneumatic headrest for maximum head and shoulder comfort
- 6 pivoting wheels (anti-oil corrosion)
- Size: 102x43x18 cm

Cod. 05.083.01 € **36,00**

**SDRAIOTTO SOTTO MACCHINA
HEAVY DUTY CREEPER**



- Plastica di alta densità
- Molto resistente
- Max. capacità: 75 kg
- Misure: 102x12x48 cm
- High-density polyethylene
- High resistance
- Max. weight load 75 kg
- Size (cm): 102x12x48 cm

Cod. 05.083.04 € **26,00**

**CARRELLO PORTA ATTREZZI DA PAVIMENTO SU RUOTE, CON SPECCHIO
FLOOR TOOL-HOLDER ON WHEELS, WITH THE MIRROR**

SPECCHIO / MIRROR



- Dimensioni: 468mm
- Altezza: 110mm
- Capacità: 100kg
- Peso: 1,4 kg
- Imballo: 47x47x6mm
- Dimensions: 468mm
- Height: 110mm
- Capacity: 100kg
- Weight: 1.4 kg
- Imballo: 47x47x6mm



Cod. 05.087.06 € **115,00**

**CARRELLO SPOSTAMENTO VETTURE INCIDENTATE
HYDRAULIC VEHICLE POSITIONING JACK**



- Capacità: 600 kg
- Max/Min apertura: 650 ÷ 300mm
- Peso: 19 kg
- Capacity: 600 kg
- Max/min width: 650 ÷ 300mm
- Weight: 19 kg

Tutte le immagini dei prodotti pubblicate in questo catalogo sono puramente indicative e possono essere cambiate senza preavviso.
All product images published in this catalogue have explanatory purposes and can be changed with no warning.

Cod. 05.073.35

€ 99,00

AVVOLGICAVO ELETTRICO AUTOMATICO 15+1 MT
15+1 MT ELECTRIC AUTOMATIC HOSE REEL

- Cursore passacavo traslante (foto A)
- Arresto e rilascio automatico
- Pulsante di ritengo posizione cavo (foto B)
- Cavo 3x1,5mm², L=15 mt+1
- Tensione: 230V
- Max. potenza: 2200W
- Dimensioni: 295x165x330mm
- Peso: 4,5 kg
- Cable slider (foto A)
- Automatic stop and spring rewind
- Cable position block button (foto B)
- Cable 3x1,5mm², L=15 mt+1
- Voltage: 230V
- Max. power: 2200W
- Dimensions: 295x165x330mm
- Weight: 4,5 kg

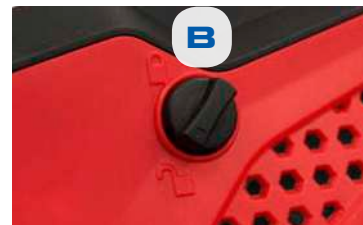
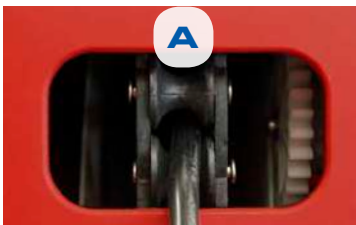

Cod. 05.073.42

€ 52,00

AVVOLGITUBO AUTOMATICO PER ARIA COMPRESSA
AUTOMATIC HOSE REEL FOR COMPRESSED AIR

- **L=10+1,5 mt**, Tubo in PVC
- ø 8 /12 mm
- Attacchi 1/4" BSPT
- Max. pressione: 10 bar
- Pulsante di blocco
- Dimensioni: 29x16,5x33 cm
- Peso: 4,3 kg

- **L = 10 + 1mt**, tubo in PVC
- ø 8/12 mm
- 1/4" BSPT connections
- Max. Pressure: 10 bar
- Lock button
- Dimensions: 29x16,5x33 cm
- Weight: 4.3 kg

Cod. 05.073.44

€ 53,00

AVVOLGITUBO PER IMPIANTI ACQUA
WATER HOSE REEL

- Tubo in PVC per acqua
- **L=10+1 mt**
- ø 8 /12 mm
- Attacchi 3/4"
- Max. pressione: 10 bar
- Pulsante di blocco
- Dimensioni: 30,5x17,5x35 cm
- Peso: 4,2 kg

- **PVC hose for water**
- **L = 10 + 1 mt**
- ø 8/12 mm
- 3/4 "connections
- Max. Pressure: 10 bar
- Dimensions: 30.5x17.5x35 cm
- Weight: 4.2 kg

Cod. 05.073.43

€ 87,00

AVVOLGITUBO AUTOMATICO PER ARIA COMPRESSA
AUTOMATIC HOSE REEL FOR COMPRESSED AIR

- **L=15+2mt**, tubo in PVC
- ø 9,5 /15,5 mm
- Attacchi 1/4" BSPT
- Pressione di lavoro: 17 bar
- Autobloccante di emergenza e riavvolgimento controllato (guida di scorrimento)
- Fissaggio a muro
- Dimensioni: 45x23,5x42,4 cm
- Peso: 8,7 kg

- **L = 15 + 2mt**, PVC hose
- ø 9.5 / 15.5 mm
- 1/4" BSPT connections
- Working pressure: **17 bar**
- Emergency self-locking and controlled rewinding (sliding guide)
- Wall fixing
- Dimensions: 45x23,5x42,4 cm
- Weight: 8,7 kg

Cod. 05.073.45

€ 72,00

AVVOLGITUBO PER IMPIANTI ACQUA
WATER HOSE REEL

- Tubo in PVC per acqua
- **L=15+1,5 mt**
- ø 1/2"
- Attacchi 3/4"
- Max. pressione: 10 bar
- Autobloccante in qualsiasi posizione e riavvolgimento controllato
- Fissaggio a muro
- Dimensioni: 30,5x17,5x35 cm
- Peso: 4,2 kg

- **PVC hose for water**
- **L = 15 + 1,5mt**
- ø 1/2"
- 3/4 "connections
- Max. Pressure: **10 bar**
- Self-locking and controlled rewinding
- Wall fixing
- Dimensions: 30.5x17.5x35 cm
- Weight: 4.2 kg

Tutte le immagini dei prodotti pubblicate in questo catalogo sono puramente indicative e possono essere cambiate senza preavviso.
All product images published in this catalogue have explanatory purposes and can be changed with no warning.

Prezzi promozionali / IVA e trasporto non incluso • Promotional prices • Precios promocionales

PROMO 2024

55

CONVERTITORI AC/DC / AC/DC CONVERTERS / CONVERTIDORES AC/DC



Foto indicativa / Indicative picture



STANDARD PER IHS1500

• COSA SONO

Dispositivi elettronici per produrre corrente alternata alimentandosi da batterie ad acido di auto e camion

• COSA SERVONO

Ad alimentare piccoli elettrodomestici, elettrodomestici, lampade, televisori, apparecchiature elettroniche, computer, forni a microonde, cellulari, pompe elettriche ecc.

• SETTORE DI IMPIEGO

Uso privato, camper, furgoni attrezzati, ambulanti, protezione civile, allestimenti autoambulanze, settore allestimenti nautici

N.B.: Se i carichi sono di tipo induttivo, si consiglia di scegliere un convertitore che abbia da 3 a 7 volte la potenza di carico applicata. Es.: un compressore per frigo da 150W richiede circa 1000W all'avviamento

• WHAT ARE THEY

Electronic devices for producing alternating current in cars and trucks by feeding on acid batteries

• WHAT ARE THEY FOR

They are used to power small appliances, electric tools, lamps, televisions, electronic equipment, computers, microwave ovens, cell phones, electric pumps etc.

• APPLICATION SECTOR

Private use, camper, equipped vans, street vendors, civil protection, ambulance equipment, nautical equip.sector

N.B.: If the loads are of inductive type, it is advisable to choose a converter that has 3 to 7 times the applied load power. Eg: a 150W fridge compressor requires about 1000W at start-up

• QUÉ SON

Dispositivos electrónicos para producir corriente alterna en automóviles y camiones mediante la alimentación de baterías ácidas.

• PARA QUÉ SON

Se utilizan para alimentar pequeños electrodomésticos, herramientas eléctricas, lámparas, televisores, equipos electrónicos, computadoras, hornos microondas, teléfonos celulares, bombas eléctricas, etc.

• SECTOR DE APLICACIÓN

Uso privado, caravana, furgonetas equipadas, vendedores ambulantes, protección civil, equipo de ambulancia, sector de equipos náuticos

N.B.: Si las cargas son de tipo inductivo, es aconsejable elegir un convertidor que tenga de 3 a 7 veces la potencia de carga aplicada. Por ejemplo: un compresor de refrigerador de 150 W requiere aproximadamente 1000W durante el arranque

CARATTERISTICHE TECNICHE TECHNICAL FEATURES CARACTERISTICA TECNICAS	MODELLI	
	IHS200 Cod. 03.050.00	IHS1500 Cod. 03.050.06
Potenza resa continua Continuous power Potencia rendimiento continuo	200W 12V DC	1500W 12V DC
Potenza di picco / Peak power / Potencia de pico	500W	3000W
Forma d'onda / Wave form / Forma de onda	Sinusoidal modificata Modified sinusoidal Sinusoidal modificada	Onda pura Pure wave
Efficienza / Efficiency / Eficiencia	>85%	>85%
Assorbimento senza carico Absorption without charge Absorción sin cargo	0,3A	
Protezione conto corto circuito Protection against short circuit Protección contra cortocircuito	Si / Yes	Si / Yes
Avvio graduale / Soft start / Arranque suave	Si / Yes	Si / Yes
Protezione sovratensione 15V DC Protection against over tension 15V DC Protección contra sobretensión 15V DC	Si / Yes	Si / Yes
Raffreddamento a ventola / Fan cooling / Ventilador de enfriamiento	No	Si / Yes
Spia allarme basso voltaggio 10V DC Alarm light for low voltage 10V DC Luz de alarma para baja tensión 10V DC	10,5V ± 0,5	10,5V ± 0,5
Interruzione alimentazione di batteria Battery power failure Interrupción de potencia en la batería	Si / Yes	Si / Yes
Protezione contro inversione di polarità Protection against reverse polarity Protección contra polaridad inversa	Si / Yes	Si / Yes
Tensione in uscita / Output tension / Tension en salida	220 AC ± 5%	220 AC ± 5%
Dimensioni mm / Peso kgs Dimensions mm / Weight kgs Dimensiones mm / Peso kgs	192x95,6x6,53 mm 0,834 kgs	420x223x103 mm 6,2 kgs
Prezzo promo Promo price Precio promo	€ 36,00	€ 398,00

ACCESSORI AUTO-VAN-CAMPER-CAMION
ACCESSORIES FOR CARS – VANS – CAMPER VANS - TRUCKS
ACCESORIOS PARA COCHES - FURGONETAS - CARAVANAS – CAMIONES

Cod. 05.090.10

€ 108,00

MOLTIPLICATORE DI COPPIA

per smontaggio bulloni di camion e furgoni

MULTIPLIER-COUPLE FOR

the disassembly of the truck and van bolts

MULTIPLICADOR DE PAR para desmontaje bulones de camiones y furgonetas

- Coppia max / Max torque / Par máx: 3800 Nm
- Rapporto riduzione / gear ratio / Relación de transmisión: 1:56
- Include 7 bussole / Incl. 7 sockets / 7 casquillos: 24 - 38 mm



Cod. 05.090.13



€ 49,00

- Coppia max / Max torque / Par máx: 3800 Nm
- Rapporto riduzione / gear ratio / Relación de transmisión: 1:56
- Include 2 bussole / Incl. 2 sockets / 2 casquillos: 32 - 33 mm



Tutte le immagini dei prodotti pubblicate in questo catalogo sono puramente indicative e possono essere cambiate senza preavviso.
All product images published in this catalogue have explanatory purposes and can be changed with no warning.

CAVI DI SOCCORSO • JUMPER CABLES • CABLES DE SOCORRO

Cod. 05.060.02 € 18,50	Cod. 05.060.03 € 26,00	Cod. 05.060.04J € 104,00
PER USO PRIVATO PRIVATE USE	PER USO PROFESSIONALE FOR PROFESSIONAL USE	PER USO PROFESSIONALE FOR PROFESSIONAL USE
		
PLACCATO IN RAME COPPER PLATED	PLACCATO IN RAME COPPER PLATED	RAME PURO 100% PURE 100% COPPER
Ampere: 350 A	Ampere: 480 A	Ampere: 1000 A
Sezione/Section: 25 mm²	Sezione/Section: 35 mm²	Sezione/Section: 70 mm²
L=3,5 mt	L=4,5 mt	L=5 mt
Uso/application: Auto - Camper - veicoli commerciali Cars - campers - commercial vehicles Coches - caravanas - vehículos comerciales	Uso/application: Auto - Camper - veicoli commerciali - autocarri Cars - campers - commercial vehicles - trucks Coches - caravanas - vehículos com. - camiones	Uso/application: Movimento terra - autocarri - bus Earth-moving machines - trucks - buses Máquinas para movimiento de tierra - camiones - autobús
Norme/norms/normas: TÜV GS CE	Norme/norms/normas: TÜV GS CE	Norme/norms/normas: CE

Cod. 05.013.04€ **28,00**
PROTEZIONE FRONTALE / LATERALE PER AUTO
FRONT / SIDE PROTECTION FOR CARS
PROTECCIÓN DELANTERA / LATERAL PARA COCHES

- Materiale: nylon impermeabile
- Dimensioni: 380x70 cm

- Material: Waterproof nylon
- Dimensions: 380x70 cm

- Material: nailon impermeable
- Dimensiones: 380x70 cm



Tutte le immagini dei prodotti pubblicate in questo catalogo sono puramente indicative e possono essere cambiate senza preavviso.
 All product images published in this catalogue have explanatory purposes and can be changed with no warning.

Cod. 04.014.01

€ 99,00



TERMOMETRO DIGITALE A RAGGI INFRAROSSI
con puntatore laser (-30/+1150°C)

DIGITAL INFRARED THERMOMETER
with laser pointer (-30/+1150°C)

TERMÓMETRO DIGITAL DE RAYOS INFRARROJOS
con puntador laser (-30/+1150°C)

APPLICAZIONI:

Automotive: collettori di scarico; marmitte catalitiche; radiatori; motori marini.

Industriali: forni; compressori; motori diesel; impianti industriali in genere; cabine di verniciatura ecc.

- Misura della temperatura senza contatto
- Spegnimento automatico
- Grado di emissività regolabile da 0,10 a 1
- Rapporto distanza-dimensioni: 20:1
- Data hold

USE:

Automotive: discharge manifolds; catalytic silencers; radiators; marine motors.

Industrial: furnaces; compressors; diesel engines; general industrial plants; spray booths; ecc.

- Non-contact temperature measurement
- Auto Power Off
- Adjustable emissivity: from 0,10 to 1
- Distance spot ratio: 20:1
- Data hold

USOS:

Automoción: colectores de descarga; catalizadores; radiadores; motores marinos

Industriales: hornos, compresores; motores diesel; instalaciones industriales, cabinas de pintura; ecc.

- Medición de la temperatura sin contacto
- Apagado automático
- Grado de emisión regulable de 0,10 a 1
- Relación distancia-dimensiones: 20:1
- Data hold

Cod. 04.013.05

€ 30,00



TERMOMETRO DIGITALE A RAGGI INFRAROSSI
con puntatore laser (-50°/+400°)

DIGITAL INFRARED THERMOMETER
with laser pointer (-50°/+400°)

TERMÓMETRO DIGITAL DE RAYOS INFRARROJOS
con puntador laser (-50°/+400°)

- Misura della temperatura senza contatto
- Spegnimento automatico
- Grado di emissività regolabile 0,95 (fisso)
- Rapporto distanza-dimensioni: 12:1
- Data hold

- Non-contact temperature measurement
- Auto Power Off
- Adjustable emissivity: from 0,95 (fixed)
- Distance spot ratio: 12:1
- Data hold

- Medición de la temperatura sin contacto
- Apagado automático
- Grado de emisión regulable 0,95 (fijo)
- Relación distancia-dimensiones: 12:1
- Data hold



Cod. 04.052.00

€ 5,95

TERMOMETRO DIGITALE A PENNA -50°/+150°C
DIGITAL PEN THERMOMETER -50°/+150°C

TERMÓMETRO TIPO BOLÍGRAFO DIGITAL -50°/+150°C

Tutte le immagini dei prodotti pubblicate in questo catalogo sono puramente indicative e possono essere cambiate senza preavviso.
All product images published in this catalogue have explanatory purposes and can be changed with no warning.

Cod. 04.003.14

€ 260,00

BT1000



Anche per batterie «start-stop»
Also for «start-stop» batteries
También para baterías «start-stop»

- **Applicazione:** Batteria 6V e 12V / Test batteria START-STOP 12V,
- Test del sistema 12V e 24V: test avviamento / test ricarica
- test IR
- Contatore numero di test (Test counter) per garanzie e controllo qualità
- Codice a barre per rintracciabilità batterie (code 39) indispensabile per gestione garanzie
- Cavi di test sostituibili in caso di danneggiamento
- Dimensioni: 251x130x45
- Accessori: guscio antiurto, rotolo carta, 6 batterie 1.5
- 6 lingue: IT/EN/FR/D/ES/PT
- **Application:** 6V & 12V battery / 12V START-STOP battery test
- System Test: 12V & 24V Starter Test/Charging Test
- IR test
- Test counter for warranty or quality control
- Bar code for the battery traceability (code 39) indispensable for warranty management
- Replaceable test cables in case of damage
- Dimensions: 251x130x45
- Accessories: shock-proof case, paper roll, 6 batteries 1.5
- 6 languages: IT/EN/FR/D/ES/PT

SET CAPACITY:
598CCA/SAEOperating Range
40~2,000 CCA(SAE)2/4
BATTERY TYPE:
AGM FLAT PLATEBattery Type:
a. Regular Liquid
b. AGM Flat Plate
c. AGM Spiral
d. VRLA/GEL1/6
SELECT RATING:
CCA/SAENorme / Global Battery Rating:
SAE(CCA), EN, IEC, DIN, JIS (Battery No.)GOOD & RECHARGE
VOL: 12.11V
CCA: 152CCA/SAE
IR: 16.22mΩSOH (State of Health)
SOC (State of Charge)BAD & REPLACE
VOL: 12.12V
CCA: 159CCA/SAE
IR: 15.46mΩ

5 Test Results:

- Good & Pass
- Good & Recharge
- Recharge & Retest
- Bad & Replace
- Bad Cell & Replace

Cod. 04.003.12

€ 188,00

BT 900

- Applicazioni: 12V batterie lead acid, AGM, EFB, GEL, URLA 12/24V test alternatori
- Display: 4 linee alfanumerico
- Campo di misura: 40 : 2000 CCA (SAE)
- Dimensioni: 235x102x68mm
- Funzioni speciali: batterie START/STOP, stampante, test su vettura in moto
- 6 lingue: EN, FR, D, ES, IT, PT
- Applications: 12V lead acid batteries, AGM, EFB, GEL, URLA 12/24V alternators test
- Display: 4 alphanumeric lines
- Measurement range: 40 : 2000 CCA (SAE)
- Dimensions: 235x102x68mm
- Special functions: START/STOP batteries, printer, test with engine on 6 languages: EN, FR, D, ES, IT, PT
- Aplicaciones: 12V con baterías de plomo ácido, AGM, EFB, GEL, URLA, 12/24V prueba de alternadores
- Pantalla: 4 líneas alfanuméricas
- Rango de medición: 40 : 2000 CCA (SAE)
- Dimensiones: 235x102x68 mm
- Funciones especiales: baterías START/STOP, impresora, prueba con motor en marcha
- 6 idiomas: EN, FR, D, ES, IT, PT



TESTER BATTERIE/ALTERNATORI con stampante
DIGITAL BATTERY/CHARGING STARTING SYSTEM TESTER with printer
NEUVO PROBADOR DE BATERÍAS con impresora

Cod. 04.003.13

€ 82,60

BT 400

- Applicazioni: 12V batterie lead acid, AGM, EFB, GEL, URLA 12/24V test alternatori
- Display: 4 linee alfanumerico
- Campo di misura: 40 : 2000 CCA (SAE)
- Dimensioni: 138x96x30mm
- Funzioni speciali: batterie START/STOP (AGM-EFB)
- 10 lingue: EN, FR, D, ES, IT, PT, NL, RU, TK, CZ
- Applications: 12V lead acid batteries, AGM, EFB, GEL, URLA 12/24V alternators test
- Display: 4 alphanumeric lines
- Measurement range: 40 : 2000 CCA (SAE)
- Dimensions: 138x96x30mm
- Special functions: START/STOP batteries (AGM-EFB)
- 10 languages: EN, FR, D, ES, IT, PT, NL, RU, TK, CZ
- Aplicaciones: 12V con baterías de plomo ácido, AGM, EFB, GEL, URLA, 12/24V prueba de alternadores
- Pantalla: 4 líneas alfanuméricas
- Rango de medición: 40 : 2000 CCA (SAE)
- Dimensiones: 138x96x30 mm
- Funciones especiales: baterías START/STOP (AGM-EFB)
- 10 idiomas: EN, FR, D, ES, IT, PT, NL, RU, TK, CZ

N.B.: I modelli BT002, 501, 222 sono ancora disponibili fino ad esaurimento scorte
The models BT002, 501, 222 remain available until stocks last
Los modelos BT002, 501, 222 quedan disponibles hasta fin de existencias



Tutte le immagini dei prodotti pubblicate in questo catalogo sono puramente indicative e possono essere cambiate senza preavviso.
All product images published in this catalogue have explanatory purposes and can be changed with no warning.

Prezzi promozionali / IVA e trasporto non incluso • Promotional prices • Precios promocionales

PROMO 2024

59

CARICABATTERIE INTELLIGENTI • SMART BATTERY CHARGERS

BUDGET

Cod. 03.024.37

€ 82,00

CBA 1000 PRO

NUOVO CARICABATTERIE INTELLIGENTE
NEW SMART BATTERY CHARGER
NUEVO CARGADOR DE BATERIA INTELIGENTE

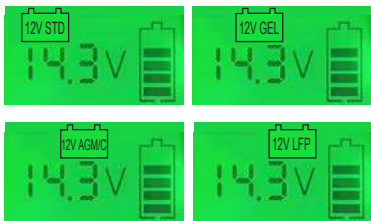
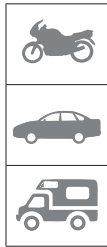

- Corrente di carica: 2A/10A
- Voltaggio della batteria: 6 V / 12 V, Potenza: 160 W
- Tensione CA: 220-240 V CA, 50-60 Hz
- Tipo di ricarica: 10 passaggi, completamente automatico
- Lunghezza cavo: 1,5 M
- Capacità della batteria: 4-200 Ah
- Classe di isolamento: IP65
- Display LCD
- Tipo di batteria: **tutti i tipi di batterie al piombo-acido da 6V/12V e batteria LiFePo4 da 12V**

- Protezione di sicurezza: inversione di polarità/surriscaldamento/cortocircuito/bassa tensione/sovraccarico
- Impostazione della modalità separata ideale per diversi tipi di batteria Ricarica come batteria normale / AGM e GEL e diverse modalità impostano diverse tensioni di spegnimento per rendere la ricarica opzionale
- 6V STD: per la carica della batteria 6V STD
- Alimentazione: conserva memoria/dati quando si sostituisce una batteria e può essere utilizzata come fonte di alimentazione a 12 V per alimentare i tuoi apparecchi a 12 V CC
- **ADATTO PER LA RICARICA DELLA BATTERIA LiFePo4 DA 12V**
- Accessori standard: doppio connettore (2 pinze e occhielli)

- Charging current: 2A / 10A
- Battery voltage: 6V / 12V, Power: 160W
- AC voltage: 220-240VAC, 50-60Hz
- Charging type: 10-Steps, Fully automatic
- Cable length: 1,5 M
- Battery capacity: 4-200 Ah
- Insulation class: IP65
- LCD Display
- **Battery Type: All type of 6V/12V Lead-Acid batteries & 12V LiFePo4 Battery**

- MCU control and LCD display
- Safety Protection: Reverse polarity/Over heat/Short Circuit/Low voltage/Over charge
- Separate Mode setting ideal for different battery types Charging like regular battery / AGM and GEL, and different modes set different off voltages to make optional charging
- 6V STD: For 6V STD battery charge
- Power supply: retain memory/data when replacing a battery & be used as a 12V power source to power up your 12V DC appliances
- **SUITABLE FOR CHARGING 12V LiFePo4 BATTERY CHARGING**
- Standard accessories: double connector (2 pliers and eyelets)

Cod. 03.024.34

€ 36,90

CBA 400 PRO

NUOVO CARICABATTERIE INTELLIGENTE
NEW SMART BATTERY CHARGER
NUEVO CARGADOR DE BATERIA INTELIGENTE

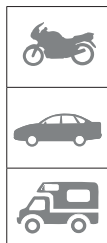

- Corrente di carica: 6V: 2A; 12V: Lenta 2A / Veloce 4A
- Voltaggio della batteria: 6V/12V, Max. Potenza: 70W
- Tensione AC: 220VAC-240VAC, 50Hz
- **Tipi di batterie: tutti i tipi di batterie al piombo-acido (WET, MF, Ca/Ca, AGM e GEL)**
- Tipo di caricabatterie: 7 fasi, ciclo di ricarica completamente automatico
- Classe di isolamento: IP65
- Cavo: 1,5mt
- Caratteristiche intelligenti di ricarica a 7 fasi
- Funzione DIAGNOSI e RESCUE
- Diverse funzioni di protezione: inversione di polarità / surriscaldamento / cortocircuito / bassa tensione / sovraccarico
- Morsetti a coccodrillo di alta qualità
- Modalità Freddo: per consentire la carica e mantenere le batterie a basse temperature

- Charging current: 6V: 2A; 12V: Slow 2A / Fast 4A
- Battery voltage : 6V/12V, Max. Power: 70W
- Voltage AC: 220VAC-240VAC, 50Hz
- **Battery Types: All type of lead-acid batteries WET, MF, Ca/Ca, AGM and GEL)**
- Charger type: 7-Step, Fully automatic charging cycle
- Insulation class: IP65
- Cable: 1.5M
- 7-step intelligent charging characteristics
- DIAGNOSIS and RESCUE function
- Various Protection Functions: Reverse polarity / Over heat / Short Circuit / Low voltage / Over charge
- High-quality crocodile clamps
- Cold Mode: to allow charge and maintain batteries at low temperatures

Tutte le immagini dei prodotti pubblicate in questo catalogo sono puramente indicative e possono essere cambiate senza preavviso.
All product images published in this catalogue have explanatory purposes and can be changed with no warning.

CHARGEMATE 12V 70A

Cod. 03.024.20

€ 536,⁰⁰

CARICABATTERIE AUTOMATICO PER BATTERIE 12V AD ACIDO, GEL, AGM, LFP

- Selezione della carica da 3 a 70A
- Funzione **ALIMENTATORE A TAMPONE** (fino a 70 A) con selezione della tensione alla batterie da 12.0 a 15.0V (step 0.1 volt) per riprogrammazione di centraline elettroniche
- Capacità di ricarica batterie: da 30 a 1800Ah
- Protezione contro sovraccarichi
- Protezione contro inversioni di polarità
- Tensione di alimentazione 220/240V 50/60Hz
- Dimensioni: 37x18x13,5cm
- Peso: 8,7kgs (con cavi)

CORREDO BASE:

Coppia cavi ad occhio 2,5mt (funzione show room) Cavi batteria staccabili sezione 16mm 2 x 2,5 mt

AUTOMATIC BATTERY CHARGER FOR 12V ACID, GEL, AGM, LFP BATTERIES

- Charge selection from 3 to 70A
- **BUFFER POWER SUPPLY** function (up to 70A) with selection of the tension supplied to the battery from 12.0 to 15.0V (0.1V step), used to reprogram control units
- Battery charge capacity: from 30 to 1800Ah
- Protection against overcharges
- Protection against polarity inversion
- Supplied tension 220/240V 50/60Hz
- Dimensions: 37x18x13,5cm
- Weight: 8,7kgs (with cables)

STANDARD OUTFITS:

Pair of 2,5mt cables with eyelet (for showrooms) Detachable battery cables diam. 16mm 2 x 2,5mt

CARGADOR DE BATERÍAS AUTOMÁTICO PARA BATERÍAS DE ÁCIDO, GEL, AGM, LFP DE 12V

- Selección de carga de 3 a 70A
- Función de fuente de **ALIMENTACIÓN DE BÚFER** (hasta 70A) con selección de la tensión suministrada a la batería de 12.0 a 15.0V (paso de 0.1V), utilizada para reprogramar unidades de control
- Capacidad de carga de la batería: de 30 a 1800Ah
- Protección contra sobrecargas
- Protección contra inversión de polaridad
- Tensión suministrada 220 / 240V 50 / 60Hz
- Dimensiones: 37x18x13,5cm
- Peso: 8,7kgs (con los cables)

EQUIPAMIENTO ESTANDAR:

Par de cables de 2,5mt con ojal (para showrooms) Cables de batería desmontables diam. 16mm 2x2.5mt



Corredo standard / Standard equipment / Equipamiento estandar

A



B



SHOW ROOM SERVICE



Tutte le immagini dei prodotti pubblicate in questo catalogo sono puramente indicative e possono essere cambiate senza preavviso.
All product images published in this catalogue have explanatory purposes and can be changed with no warning.

CARICABATTERIE • BATTERY CHARGERS • CARGADORES DE BATERIA



SMART

12V WET / VRLA / GEL / MF / AGM (START-STOP)
LA/CA / LITHIUM LIFEPO4 (SMART LITHIUM)



MADE IN ITALY

**“SMART” NUOVA GAMMA
DI CARICABATTERIE AUTOMATICI**

- Aumentano la vita e lo spunto della batteria
- Elevate prestazioni di carica e mantenimento
- Ricaricano di batterie profondamente scariche
- Massima efficienza, minimo consumo energetico
- 100% automatici

CARATTERISTICHE TECNICHE

- > Multi-ciclo con microprocessore
- > Recupero, carica, mantenimento test batterie
- > Idoneo per tutte le batterie al piombo-acido e batterie al litio LiFePO4 (Mod. SMART LITHIUM)
- > Il dispositivo può rimanere sempre collegato alla batteria
- > Cablaggio a tenuta stagna permette un collegamento alla batteria comodo e veloce
- > 100% sicuro: 8 protezioni
- > Alimentazione: 220 ÷ 240V, 50 ÷ 60Hz
- > Resistente agli agenti atmosferici esterni IP 44
- > 3 anni garanzia

CORREDO STANDARD

- > Cavi di collegamento con connessioni “Superseal”

**“SMART” IS THE NEW RANGE OF
MULTI-CYCLE & AUTOMATIC BATTERY CHARGERS**

- Preserve the battery life and power
- High charge performance and maintenance
- Recharge of deep discharged batteries
- Highest efficiency, lowest energy consumption
- 100% automatic

TECHNICAL FEATURES

- > Multi-cycle with microprocessor
- > Recovery, charge, maintenance and battery test
- > Suitable for all types of lead-acid batteries and LiFePO4 batteries (Mod. SMART LITHIUM)
- > The device can stay always connected to the battery
- > The water-proof wiring cable allows a fast and easy connection to the battery
- > 100% safe: 8 different protections
- > IP 44 Weatherproof
- > 3 year warranty

STANDARD OUTFITS

- > External cables with connections “Superseal”



Corredo standard / Standard outfits



- > Cavi di collegamento con connessioni “Superseal”
- > External cables with connections “Superseal”

PROMO 2024

CARICABATTERIE • BATTERY CHARGERS • CARGADORES DE BATERIA

5 ANNI GARANZIA
WARRANTY 5 YEARS
GARANTIA 5 AÑOS
GARANTIE 5 ANS
5 JAHREN GARANTIE



Modelli disponibili Available models	SMART 200 Cod. 03.024.30	SMART 400 Cod. 03.024.31	SMART 1000 Cod. 03.024.32	SMART LITHIUM Cod. 03.024.33
Volt	6/12V	12V	12V	12V
Capacità batterie Battery capacity	3-100Ah	3-150Ah	3-200Ah	3-100Ah
A max	2	4	10	1,5
Piombo acido Lead-Acid (wet, gel, MF, AGM, VRLA)	✓	✓	✓	✓
Litio Lithium (Life PO4)	—	—	—	✓
Programmi di carica speciali Special charging programs	—	Auto&Moto+AGM Car&Bike+AGM	Auto&Moto+AGM Car&Bike+AGM	—
Modalità alimentazione Power Supply Mode	—	✓	✓	—
Algoritmo di carica – 8 passi Charging algorithm – 8 Steps	✓	✓	✓	✓
PROTEZIONI Corto circuito, inversione di polarità, sovraccarica e surriscaldamento PROTECTIONS Short circuit, polarity inversion, overcharging and overheating	✓	✓ + Compensazione temperatura + Temperature Compensation	✓ + Compensazione temperatura + Temperature Compensation	✓ + Polar Mode
Prezzo promo: Promo price:	€ 46,00	€ 67,90	€ 98,50	€ 56,90

ALGORITMO DI CARICA / CHARGING ALGORITHM

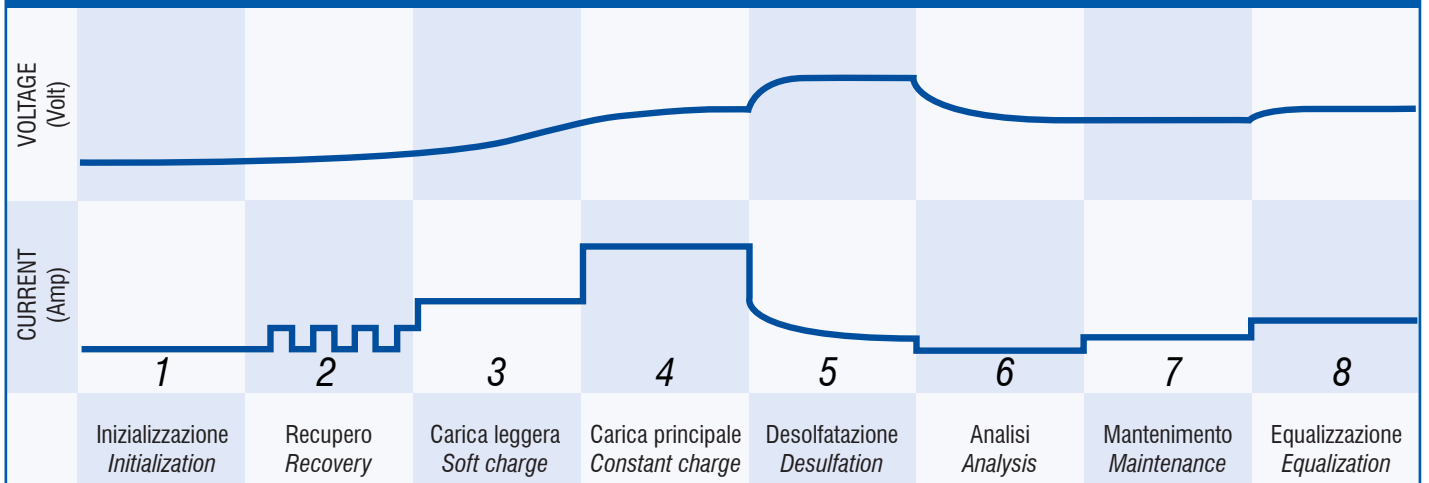





Tutte le immagini dei prodotti pubblicate in questo catalogo sono puramente indicative e possono essere cambiate senza preavviso.
All product images published in this catalogue have explanatory purposes and can be changed with no warning.

CARICABATTERIE RAPIDO INTELLIGENTE INTELLIGENT FLASH BATTERY CHARGERS



PROMO 2024

 <p>CHARGE</p>	<p>La modalità CARICA può essere utilizzata per ricaricare e ricondizionare automaticamente batterie di tutti i tipi e dimensioni, comprese le LiFePo4. Il programma di ricondizionamento automatico riporterà in vita le batterie vecchie e usate prolungandone la durata. Durante la ricarica sullo schermo viene visualizzata la percentuale di carica e la corrente di carica.</p> <p><i>The CHARGE mode can be used to recharge and automatically recondition batteries of all types and sizes including LiFePo4. The automatic reconditioning program will bring life back into old and used batteries extending their life. During charging the percentage of charge is displayed on the screen as well as the charging current.</i></p>
 <p>TEST</p>	<p>Il caricabatterie è in grado di testare sia la batteria che il sistema di avviamento di un veicolo. Il TEST del sistema di avviamento indicherà la tensione più bassa nel sistema durante l'avviamento e visualizzerà graficamente la forma d'onda. Entrambi i test possono aiutare a identificare rapidamente eventuali problemi sul veicolo in modo rapido e senza richiedere apparecchiature aggiuntive.</p> <p><i>The charger is able to TEST both the battery and the starting system of a vehicle. The starting system test will indicate the lowest voltage in the system during cranking as well as displaying the waveform graphically. Both tests can help to rapidly identify any potential issues with a vehicle quickly and without requiring any additional equipment.</i></p>
 <p>DIAGNOSTIC</p>	<p>In modalità DIAGNOSTICA la tensione di uscita dei caricabatterie è selezionabile in modo da poterla adattare ai requisiti del veicolo. Una volta alimentati, i computer di bordo del veicolo possono essere testati e riprogrammati in un ambiente sicuro e stabile. Questo è un requisito fondamentale dei veicoli moderni con elettronica di bordo sensibile e costosa.</p> <p><i>In DIAGNOSTIC mode the output voltage of the chargers is selectable so that it can be tuned to the requirements of a vehicle. Once supplied with power the vehicle's onboard computers can be tested and re-programmed in a safe and stable environment. This is a critical requirement of modern vehicles with sensitive and expensive onboard electronics.</i></p>
 <p>SHOWROOM</p>	<p>In modalità SHOWROOM il caricabatterie fornirà al veicolo tutta la potenza necessaria mentre è in modalità dimostrazione. Ciò consente alle luci, ai sistemi elettronici e agli ausiliari di funzionare continuamente mentre il veicolo viene presentato ai potenziali clienti senza scaricare completamente o danneggiare la batteria di avviamento del veicolo. Il caricabatterie può essere nascosto sotto il veicolo, lontano dalla vista.</p> <p><i>In SHOWROOM mode the charger will supply the vehicle with all of the power required while it is in demonstration mode. This allows lights, electronic systems and auxiliaries to run continuously while the vehicle is being presented to potential customers without deeply discharging or damaging the vehicles starting battery. The charger can be hidden under the vehicle out of sight.</i></p>

Tutte le immagini dei prodotti pubblicate in questo catalogo sono puramente indicative e possono essere cambiate senza preavviso.
All product images published in this catalogue have explanatory purposes and can be changed with no warning.

Cod. 03.024.43

€ 660,00

CBA AUTO F35 12-24V

NEW!
2024

- Ingresso: 200-240V AC (50-60 Hz)
- Tensione di uscita: **12/24V**
- Potenza di ingresso: **1000W**
- Corrente di alimentazione massima: **35A**
- Corrente di alimentazione continua: **35A**
- Lunghezza del cavo: 3m
- Compatibile con batterie al piombo **4-700Ah**

- Input: 200-240V AC (50-60 Hz)
- Output Voltage: **12/24V**
- Input Power: **1000W**
- Max Supply Current: **35A**
- Continuous Supply Current: **35A**
- Cable length: 3m
- Compatible with Lead-acid batteries **4-700Ah**



LEAD ACID

LITHIUM



Cod. 03.024.42

€ 1.080,00

CBA AUTO F150 12V

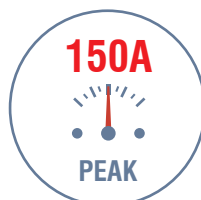
NEW!
2024

- Ingresso: 200-240V AC (50-60 Hz)
- Tensione di uscita: **12V**
- Potenza di ingresso: **1400W**
- Corrente di alimentazione massima: **150A** (3 minuti)
- Corrente di alimentazione continua: **120A**
- Lunghezza del cavo: **3m**
- Compatibile con batterie al piombo **20-2000Ah**

- Input: 200-240V AC (50-60 Hz)
- Output Voltage: **12V**
- Input Power: **1400W**
- Max Supply Current: **150A** (3 minutes)
- Continuous Supply Current: **120A**
- Cable length: **3m**
- Compatible with Lead-acid batteries **20-2000Ah**



LEAD ACID

LITHIUM



Tutte le immagini dei prodotti pubblicate in questo catalogo sono puramente indicative e possono essere cambiate senza preavviso.
All product images published in this catalogue have explanatory purposes and can be changed with no warning.

Prezzi promozionali / IVA e trasporto non incluso • Promotional prices • Precios promocionales

PROMO 2024

65

CARICABATTERIE • BATTERY CHARGERS • CARGADORES DE BATERIA



CHARGEMATE 130A 12V

Cod. 03.024.22

€ 1.230,00

CARICABATTERIA A 8 CICLI E ALIMENTATORE PROFESSIONALE 130A 12V

- Caricabatterie e alimentatore per ogni tipo di batteria (incluso Start&Stop e Lithium)
- Software specifico per la ricarica batterie Lithium (25% - 50% - 75% - 100%) in accordo con norme per lo stoccaggio
- Solo 10 cm di altezza
- Display alfanumerico 4 righe con indicazione del tipo di batteria (1)
- Ampere di carica (2)
- Volt di carica (3)
- Capacità residua della batteria (4)
- Timer (5)
- Ripristina automaticamente la funzione precedente, in caso di black out
- Alimentatore garantito per 24 ore al 100% della capacità selezionata
- 6 livelli di tensione
12.8 / 13.6 / 13.8 / 14.0 / 14.4 / 14.8V selezionabili

Tensione ingresso Input Voltage	100 ÷ 240V ac, 50-60Hz
Tensione carica Output Voltage	13.8V/14.7V - nom. 12V
Corrente di carica Charging Current	da/from 1A a/to 130A, selezionabile / selectable
Capacità batterie Battery Capacity	10-1300Ah
Tensione alimentatore Power Supply Voltage	da/from 12.8V a/to 14.8V, selezionabile / selectable
Sezione cavi Cable Diameter	25 mm ²
Lunghezza cavi Cable Length	3 m
Dimensioni Size	37 x 22 x 10 cm
Peso Weight	4.6 Kg

PROFESSIONAL 8 STEPS CHARGER & POWER SUPPLY 130A 12V

- Charger and power supply for every type of battery (including Start & Stop and Lithium)
- Specific software for recharging Lithium batteries (25% - 50% - 75% - 100%) according to storage standards
- Height 10 cm only
- 4 lines alphanumeric display with battery type indication (1)
- Charged Ampere (2)
- Charged Voltage (3)
- Residual battery capacity (4)
- Timer (5)
- Automatically resets the previous function in case of a blackout
- Guaranteed power supply for 24h at 100% of the selected capacity
- 6 selectable voltage levels:
12.8 / 13.6 / 13.8 / 14.0 / 14.4 / 14.8V

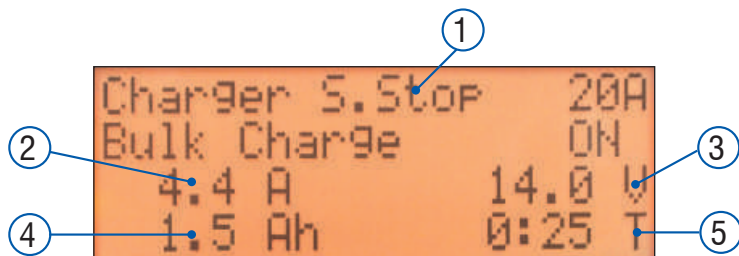

Ultrapiatto, posizionabile sotto le auto in showroom
Ultra-flat, it can be placed under cars in showroom



Tutte le immagini dei prodotti pubblicate in questo catalogo sono puramente indicative e possono essere cambiate senza preavviso.
All product images published in this catalogue have explanatory purposes and can be changed with no warning.

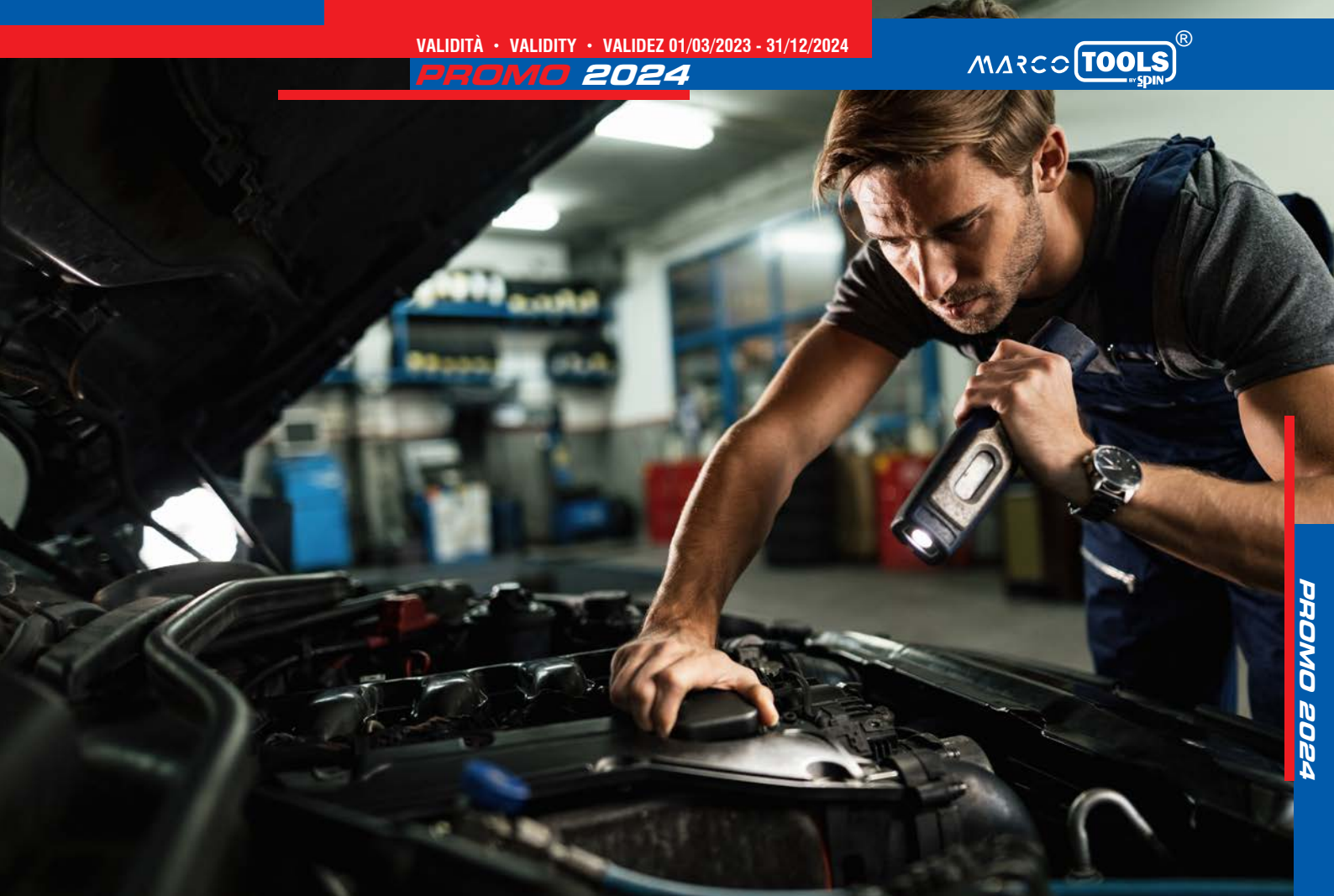

PROMO 2024

LAMPADE
LAMPS
LÁMPARAS



Tutte le immagini dei prodotti pubblicate in questo catalogo sono puramente indicative e possono essere cambiate senza preavviso.
All product images published in this catalogue have explanatory purposes and can be changed with no warning.

Prezzi promozionali / IVA e trasporto non incluso • Promotional prices • Precios promocionales

PROMO 2024

67

Cod. 05.073.53

€ 76,00

LAMPADA SOTTOCOFANO MULTIUSO
UNDER BONNET LAMP (MULTIPURPOSE)

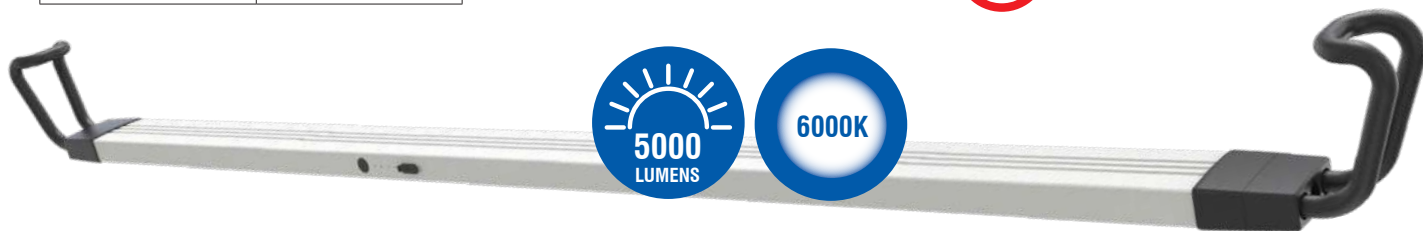

- 3 livelli di potenza luminosa:
- 3 levels of light power:

20% - 1000 lumen / lumens

50% - 2500 lumen / lumens

100% - 5000 lumen / lumens

- Temperatura di colore: 6000K
- Color temperature: 6000

- Luce bianca intensa
- Bright white light

- Robusta struttura in alluminio
- Sturdy aluminum structure

- Autonomia / Autonomy:

Modalità 20% - 15 ore / 20% mode - 15 hours

Modalità 50% - 6 ore / 50% mode - 6 hours

Modalità 100% - 3 ore / 100% mode - 3 hours

- Tempo di ricarica: 5 ore con caricabatterie usb incluso 2A/5V
- Charging time: 5 hours with 2A/5V usb charger

- Ganci rotanti a 360° per le più svariate applicazioni
- 360° rotating hooks for various applications

- Lunghezza: min. 116 / max 170 mm
- Length: min. 116 / max 170mm

116 cm

170 cm

Spessore / Thickness
22 mm

360°

360°

53 mm



Tutte le immagini dei prodotti pubblicate in questo catalogo sono puramente indicative e possono essere cambiate senza preavviso.
All product images published in this catalogue have explanatory purposes and can be changed with no warning.

Cod. 05.073.25T

€ 44,⁰⁰Prezzi netti per quantità
Net prices for min. q.ty**LAMPADA U/V RICARICABILE**
RECHARGEABLE U/V LAMP
LAMPARA U/V RECARGABLE

- Batteria/Battery/Bateria Li-ion/Ion Litio 3,7V 2200mAh
- Isolamento/Insulation/Aislamiento IP65
- Completa di caricabatterie AC e da presa accendisigari / with AC battery charger and cigarette lighter plug / completa con cargador de batería AC y toma de encendedor de cigarrillos: 100/240 V AC
- Occhiali/goggles/gafas
- Funzioni/Functions/Funciones: 100% - 50% - SOS - OFF

Cod. 05.073.24T

€ 22,⁵⁰Prezzi netti per quantità
Net prices for min. q.ty**TORCIA U/V A BATTERIA**
U/V FLASHLIGHT WITH BATTERIES
LAMPARA U/V DE MANO CON BATERIAS

- Torcia U/V a batteria
- U/V flashlight with battery
- 1x1,5V batteria inclusa
- 1x1,5V battery (included)
- Occhiali
- Goggles
- Confezione: cartone
- Packaging: cardboard
- Lampara U/V de mano con 1 batteria
- 1x1,5V batería (incluida)
- Gafas
- Embalaje: carton

Cod. 05.073.25TK

€ 86,⁰⁰Prezzi netti per quantità
Net prices for min. q.ty

Cod. 05.073.24TK

€ 64,⁵⁰Prezzi netti per quantità
Net prices for min. q.ty

HF01234yf

R134a



HF01234yf

R134a

Cod. 05.073.46

€ 12,⁵⁰**SFERA DI LUCE CON MAGNETE**
MAGNETIC LIGHT SPHERE
LÁMPARA ESFÉRICA IMANTADA250
LUMEN

Cod. 05.073.38

€ 43,⁹⁰**SFERA DI LUCE CON MAGNETE (BATTERIE RICARICABILI)**
MAGNETIC LIGHT SPHERE (RECHARGEABLE BATTERIES)
LÁMPARA ESFÉRICA IMANTADA (BATERIAS RECARGABLES)

- Sfera magnetica orientabile a 360°
- 3 posizioni: luce centrale, luce totale, spenta
- Luminosità: 250 lumen
- Alimentazione: 3 x batterie 1,5V AAA (non incluse)

- 360° adjustable magnetic sphere
- 3 positions: central light, total light, off
- Brightness: 250 lumen
- Power supply: 3 x 1,5V AAA batteries (not included)

- Esfera magnética ajustable 360°
- 3 posiciones: luz central, luz total, apagada
- Brillo: 250 lúmenes
- Fuente de alimentación: 3 pilas de lápiz óptico de 1,5 V AAA (no incluido)

Tutte le immagini dei prodotti pubblicate in questo catalogo sono puramente indicative e possono essere cambiate senza preavviso.
All product images published in this catalogue have explanatory purposes and can be changed with no warning.

Prezzi promozionali / IVA e trasporto non incluso • Promotional prices • Precios promocionales

PROMO 2024

69



Cod. 05.073.28

€ 16,00

LAMPADA A LUCE SOLARE DA PARETE,
con sensore di movimento (da esterno)

SUNLIGHT LAMP WITH MOTION SENSOR,
wall mounted (outdoor)

LÁMPARA DE LUZ SOLAR CON SENSOR DE MOVIMIENTO,
montada en pared (para uso en exteriores)

DATI TECNICI:

- Pannello solare da 5,5V/0,6W/ Efficienza 17%
- Batteria al litio 3,7V/1800mAh
- Rileva presenza di persone da 3 a 6mt
- Luminosità: 450 lumen
- Potenza: COB LED 10W
- Grado di isolamento: IP65
- Dimensioni: 153x105x49mm
- Peso: 237gr

TECHNICAL FEATURES:

- Solar panel 5.5V / 0.6W / 17% efficiency
- 3.7V / 1800mAh lithium battery
- It detects the presence of people from 3 to 6mt
- Brightness: 450 lumens
- Power: COB LED 10W
- Degree of insulation: IP65
- Dimensions: 153x105x49mm
- Weight: 237gr

DATOS TÉCNICOS:

- Panel solar de 5.5V / 0.6W / 17% de eficiencia
- Batería de litio 3.7V / 1800mAh
- Detecta la presencia de personas de 3 a 6 mt
- Luminosidad: 450 lúmenes
- Potencia: COB LED 10W
- Grado de aislamiento: IP65
- Dimensiones: 153x105x49mm
- Peso: 237gr

Cod. 05.073.29

€ 21,00



LAMPADA FRONTALE
con batterie ricaricabili a ioni di litio

FRONT LAMP
with rechargeable lithium ion batteries

LÁMPARA FRONTAL
con baterías recargables de iones de litio

DATI TECNICI:

- 5W di potenza lampada frontale
- 3W di potenza luce posteriore
- 4 modalità di regolazione: lampada frontale (100%, 50%, 25%, OFF)
- Autonomia: 100% 2,5-3h; 50% 5-7h; 25% >10h
- **Cavo USB incluso**

TECHNICAL FEATURES:

- 5W of power - front lamp
- 3W of power - rear light
- 4 adjustment modes: front lamp (100%, 50%, 25%, OFF)
- Autonomy: 100% 2.5-3h; 50% 5-7h; 25% > 10h
- **USB cable incl.**

DATOS TÉCNICOS:

- 5W de potencia - luz delantera
- 3W de potencia - luz trasera
- 4 modos de ajuste: luz delantera (100%, 50%, 25%, OFF)
- Autonomía: 100% 2.5-3h; 50% 5-7 h; 25% > 10h
- **Cable USB incluido**

Principali applicazioni

- Settore "bike"
- Settore trekking e climbing
- Cantieristica in genere
- Protezione civile
- Antinfortunistica

Principali applicazioni

- Bike sector
- Trekking and climbing sector
- Building industry in general
- Civil protection
- Accident prevention

Principali aplicaciones

- Sector "Bicicleta"
- Sector trekking y escalada
- Industria de construcción en general
- Protección civil
- Prevención de accidentes



Luce con zoom, angolo regolabile
Twist to zoom, adjustable angle
Torcer para hacer zoom, ángulo ajustable



Cavo di estensione
Extension cable
Cable de extensión



Vano batterie separabile con luce COB
(rossa/bianca)
Detachable battery box with COB light (red/white)
Caja de baterías desmontable con luz COB
(roja / blanca)



Luce di sicurezza rossa COB
Red COB safety light
Luz de seguridad roja COB

Tutte le immagini dei prodotti pubblicate in questo catalogo sono puramente indicative e possono essere cambiate senza preavviso.
All product images published in this catalogue have explanatory purposes and can be changed with no warning.



Cod. 05.073.30

€ 40,⁹⁰

1000 LUMEN

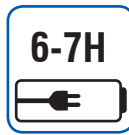

Cod. 05.073.52

€ 24,⁹⁰

LAMPADA LED 5W +1 W COB ricaricabile
5W +1 W COB rechargeable WORK LAMP
LAMPARA LED 5W +1 W COB recargable

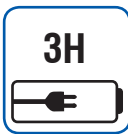

• Luminosità:

Corpo 5W COB (ca. 350 Lumen)
Torchia 1W LED (ca. 180 Lumen)

- Materiale: ABS+PC+TPR
- Batteria: batteria al litio da 3,7V 2000mAh
- Autonomia: ca. 3 ore
- Tempo di ricarica: ca. 3 ore
- Gancio girevole a 360°
- Staffa girevole a 180°
- Spia di carica
- Cavo USB e adattatore 5V 1A
- Funzione di regolazione intensità luce
- Forte magnete sulla staffa e sul retro della lampada

• Brightness:

Body: 5W COB (circa 350 Lumen)
Torch: 1W LED (circa 180 Lumen)

- Material: ABS+ PC+ TPR
- Battery: 3.7V 2000mah Li-ion battery
- Working time: about 3 hours
- Charging time: about 3 hours
- 360° rotating hook
- 180° rotating bracket
- Charging indicator light
- USB cable and 5V 1A adapter
- Stepless dimming function
- Strong magnet on the bracket and back of lamp

• Brillo:

Cuerpo: 5W COB (aprox. 350 lúmenes)
Linterna: LED de 1 W (aprox. 180 lúmenes)

- Material: ABS + policarbonato + TPR
- Batería: batería de litio de 3,7 V 2000 mAh
- Autonomía: aprox. 3 horas
- Tiempo de carga: aprox. 3 horas
- Gancho giratorio de 360°
- Soporte giratorio de 180°
- Luz de carga
- Cable USB y adaptador 5V 1A
- Función de ajuste de la intensidad de la luz
- Fuerte imán en el soporte y en la parte posterior de la lámpara

Cod. 05.073.40

€ 31,00

Prezzi netti per quantità
Net prices for min. q.ty



LAMPADA 5W COB CON 2 ASSI GIREVOLI E TORCIA
2 AXIS ROTATABLE 5W + 1W TORCH COB LAMP

- LED: 5W COB + 1W SMD
- Batteria: 3.7V 2600mAh 18650 Li
- Luminosità: circa 400LM per il corpo lampada COB, circa 80LM per torcia SMD
- Modalità di commutazione: COB regolabile, interruttore ON / OFF per torcia SMD
- Ore di lavoro: circa 3 ore per lampada COB, circa 12 ore per torcia SMD
- Tempo di ricarica: ca. 4 ore
- Con adattatore CA di 5,5 mm di foro di carica CC, con batteria e indicatore di carica
- Un forte magnete alla base della lampada e due forti magneti nella parte posteriore
- Gancio di traino
- Materiale: ABS + alluminio + PC + gomma
- **Cavo e carica batterie 230V incluso**

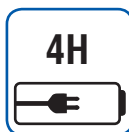

Cod. 05.073.39

€ 32,00

5W +1W COB

Prezzi netti per quantità
Net prices for min. q.ty



LAMPADA INTERCambiabile 2 IN 1
INTERCHANGEABLE 2 IN 1 LAMP

- LED
- Batteria 3,7V 2200mAh ricaricabile
- **Corpo in alluminio**
- Luminosità:
 - COB: 400lm/200lm
 - Torcia: 50lm
 - Torcia elettrica: 350/180lm
- Caricabatterie: 1A 100/240V



Corpo porta batterie orientabile
Adjustable battery holder body

Lampada COB SLIM
COB SLIM lamp

Torcia elettrica
Electric torch

Tutte le immagini dei prodotti pubblicate in questo catalogo sono puramente indicative e possono essere cambiate senza preavviso.
All product images published in this catalogue have explanatory purposes and can be changed with no warning.

Cod. 05.073.47

€ 59,⁰⁰**UV LAMP****INNOVATIVA LAMPADA DISINFETTANTE A RAGGI UV-C
INNOVATIVE UV-C DISINFECTANT LAMP**

- Con 18 led, batteria ricaricabile 3,7V 2000mAh
- Idonea per sterilizzare mascherine, cellulari, tastiere, abiti, piani di lavoro, divani, letti, sanitari, gioielli, oggetti per la cura della persona
- **In meno di 1 minuto abbattimento del 99,9% di batteri**
- Spegnimento automatico se rivolto verso il viso o corpo
- Ricarica automatica con cavo mini USB
- 1° carica: 4-5h; autonomia 3h
- 18 LEDs, 3.7V, 2000mAh rechargeable battery
- Suitable for sterilizing masks, cell phones, keyboards, clothes, worktops, sofas, beds, sanitary ware, jewelry, personal care items
- **In less than 1 minute, 99.9% killing of bacteria**
- Automatic shutdown if facing towards the face or body
- Automatic charging with mini USB cable
- First charge: 4-5h; 3h autonomy



Cod. 05.073.49

€ 34,⁹⁰**FARETTO 10W COB CON MANIGLIA MAGNETICA
10W COB WORK LIGHT WITH MAGNETIC HANDLE
LUZ DE TRABAJO DE 10W COB CON MANGO MAGNÉTICO**

- Proiettore da 10W con luce diffusa
- Materiale: nylon / TPR
- Batteria ricaricabile da 3,7 V 4400 MAh
- Power bank con indicazione di carica
- Caricatore AC / DC
- USB, micro porta
- Manico a 180 gradi
- Dim: 17.2x12.7x4.2 cm
- Dim. imballo: 20.5x15.5x5.5 cm
- Peso netto/lordo: 0,450/0,535 kg
- 10W handle use design flood light
- Material: Nylon /TPR
- 3.7V 4400 MAh rechargeable battery
- Power bank with charging indication
- AC/DC charger
- USB, micro port
- 180 degree handle
- Dim: 17.2x12.7x4.2 cm
- Pack. dim: 20.5x15.5x5.5 cm
- N/G weight: 0,450/0,535 kg
- Proyector de 10W con luz difusa
- Material: nailon / TPR
- Bateria recargable de 3.7V 4400 MAh
- Power bank con indicación de carga
- Cargador AC/DC
- USB, puerto micro
- Mango de 180 grados
- Dim: 17.2x12.7x4.2 cm
- Dim.de embalaje: 20.5x15.5x5.5 cm
- Peso neto / bruto: 0,450/0,535 kg



Tutte le immagini dei prodotti pubblicate in questo catalogo sono puramente indicative e possono essere cambiate senza preavviso.
All product images published in this catalogue have explanatory purposes and can be changed with no warning.

Prezzi promozionali / IVA e trasporto non incluso • Promotional prices • Precios promocionales

PROMO 2024

73

Cod. 05.075.16

€ 1.350,00

420 L
INDUSTRIAL

SABBIATRICE INDUSTRIALE

con aspiratore a ciclone 420 lt con apertura superiore

PNEUMATIC SANDBLASTER

with 420 lts cyclone vacuum, with top opening door



- Comando a pedali
- L'aspiratore a ciclone assicura una estrazione di polvere e sabbia in continuo
- L'illuminazione interna (alogeno)
- Apertura ampia per l'introduzione dei pezzi
- Regolatore di pressione
- Dimensioni esterne: 1210x610x1700 mm
- Dimensioni camera interna: 1200x600x370/600 mm
- Dimensioni porta accesso: 1000x570cm
- Dimetro ugello: 7 mm
- Consumo d'aria: 630 lt/min
- Aspiratore elettrico: 1.200W
- Pressione di lavoro: 3,5 ÷ 5,5 bar
- Max. pressione ammessa: 8 bar
- Alimentazione: 230 V 50H7
- Dim. imballo/peso: 1290x1260x770mm / 160 kg

ACCESSORI STANDARD:

- 4 ugelli
- 1 pistola sabbiatrica (industriale)
- 2 lampade alogene
- 5 protezioni per luce interna
- 2 nastri a rullo
- 1 nastro a rullo teflon
- 1 contenitore a ciclone
- 1 comando a pedale
- 1 separatore acqua-aria

- Foot pedal operated
- The cyclonic vacuum assures the continuous extraction of the dust and the sand
- Inner lighting (halogen)
- Large opening for the insertion of the components
- Pressure regulator
- External dimensions: 1210x610x1700mm
- Blasting cabinet size: 1200x600x370/600mm
- Opening door size: 1000x570cm
- Nozzle size: 7 mm
- Air consumption: 630 lt/min
- Vacuum generator: 1.200W
- Operating pressure: 3,5 ÷ 5,5 bar
- Max. pressure: 8 bar
- Voltage: 230 V 50H7
- Pack.dim./weight: 1290x1260x770mm / 160 kg

STANDARD EQUIPMENT:

- 4 ceramic nozzles
- 1 sand blasting gun (industrial)
- 2 halogen lamps for the inner lighting
- 5 safety films for the inner lighting
- 2 rolls of sealant tape
- 1 roll teflon sealant
- Cyclone tank
- Control pedal
- 1 water-separator

220 L



Cod. 05.075.10

€ 382,00

**SABBIATRICE PNEUMATICA
PNEUMATIC SANDBLASTER**

- Pressione d'ingresso: 2,8÷5,6bar (40-80 PSI)
- Consumo d'aria: 450÷550 lt/min
- Dimensioni camera: 596x838x625mm
- Dimensioni imballo: 96x62x62,5cm
- Peso netto/lordo: 48/51kg
- Predisposizione per aspiratore (non fornito)

ACCESSORI STANDARD:

- Coppia guanti L=60cm
- Set ugelli pistola
- Pistola sabbiatrica

- Inlet pressure: 2.8÷5.6bar (40-80 PSI)
- Air consumption: 450÷550 lt /min
- Chamber size: 596x838x625mm
- Package dimensions: 96x62x62,5cm
- Net/gross weight: 48/51kg
- Predisposition for aspirator (not supplied)

STANDARD ACCESSORIES:

- Pair of gloves L=60cm
- Set nozzles for gun
- Gun for sandblaster

Tutte le immagini dei prodotti pubblicate in questo catalogo sono puramente indicative e possono essere cambiate senza preavviso.
All product images published in this catalogue have explanatory purposes and can be changed with no warning.

Cod. 05.075.17

€ **422,00**

SABBIATRICE CARRELLATA con aspiratore incorporato da 105 lt
105 LT SANDBLASTER WITH WHEELS with built-in vacuum device

105 L



- Aspiratore incorporato
- Consente l'uso continuo dell'apparecchio
- Recupera le parti di abrasivo separandole dalla polvere
- Può essere usato su pietra e superfici metalliche
- Pressione aria compressa: 8 bar
- Consumo di aria: 170÷640 lt/min (a seconda dell'uso)
- **A:** Aspiratore da 1200W
- **B:** Spazzola
- Connessione aria: 1/2"
- Capacità serbatoio: 105lt, 1041x367(Ø)mm
- Dim. imballo: 1020x460x520mm
- Peso netto/lordo: 36kg /40 kg
- Built-in vacuum
- it allows continuous work
- recovers abrasive parts separating them from dust
- It can be used on stone or metallic surfaces
- Compressed air pressure: 8 bar
- Air consumption: 170÷640 lt/min (depending on use)
- **A:** 1200W Vacuum device
- **B:** Brush
- Air connection: 1/2"
- Tank size: 105lt 1041x367(Ø)mm
- Pack. dim: 1020x460x520mm
- Net/gross: 36kg /40 kg

Cod. 05.075.30

€ **152,00**

SABBIATRICE DA BANCO, 90 LT
90 LT TABLE SANDBLASTER

90 L



- Cabinet in acciaio resistente con porta superiore
- Capacità della sabbia nell'imbuto: 6.5 L
- Consumo d'aria: 240/300 lt/min
- Spazio di lavoro: 580x480x350 mm
- Capacità compressore d'aria: 40-120 PSI
- Tensione di uscita: 12V; Potenza: 8W
- Dim. imballo/peso: 630x550x225 mm, 20 kg
- Heavy duty steel cabinet with upper door
- Sand capacity in the funnel: 6.5 L
- Air consumption: 240/300 lt/min
- Work space: 580x480x350 mm
- Air compressor capacity: 40-120 PSI
- Output voltage: 12V; Power: 8W
- Packaging size/weight: 630x550x225 mm, 20 kg

Cod. 05.075.31.R1

Prezzo a richiesta
Price on request



ADATTATORE PER ASPIRAPOLVERE
ESTERNO per sabbiatrici 05.075.10 / 05.075.30
ADAPTER FOR DUST ASPIRATOR
for the sandblasters
05.075.10 / 05.075.30

RICAMBI SABBIATRICI / SANDBLASTERS SPARE PARTS

Ricambi sabbiatrici Sandblasters spare parts	 Cod. 05.075.16	 Cod. 05.075.10	 Cod. 05.075.17	 Cod. 05.075.18
Set ugelli Set of nozzles	 Cod. 05.075.22 € 11,00	 Cod. 05.075.11 € 4,80	 Cod. 05.075.26 € 4,60	 Cod. 05.075.24 € 4,60
Pistola sabbiatrica Blasting gun	 Cod. 05.075.23 <small>Prezzo a richiesta Price on request</small>	 Cod. 05.075.13 € 19,00	 Cod. 05.075.28 € 13,50	 Cod. 05.075.29 € 13,50
Coppia guanti Pair of gloves	 Cod. 05.075.12 € 31,00	 Cod. 05.075.12 € 31,00	Tubo 2,5 mt per sabbiatrica cod. 05.075.18 2,5mt hose for sandblaster cod. 05.075.18 Cod. 05.075.25 € 14,00	

MATERIALE DI CONSUMO
CONSUMABLES

Cod. 05.075.14 € **52,00**

Corindone 80 grana per sabbiatrica. Sacco da 25kg
Corundum 80 micron for the sandblaster, 25kg bag

Cod. 05.075.15 € **52,00**

Corindone 60 grana per sabbiatrica. Sacco da 25kg
Corundum 60 micron for the sandblaster, 25kg bag

Cod. 05.075.27 € **56,00**

Microsfere, grana 40/70 micron, sacco da 25kg
Micro glass beads, grain size 40/70 micron, 25kg bag

Tutte le immagini dei prodotti pubblicate in questo catalogo sono puramente indicative e possono essere cambiate senza preavviso.
All product images published in this catalogue have explanatory purposes and can be changed with no warning.

Prezzi promozionali / IVA e trasporto non incluso • Promotional prices • Precios promocionales

CK-EXPORT
U/S WASHING TANKS

VASCHE AD ULTRASUONI SERIE CK-EXPORT
ULTRASONIC WASHING TANKS CK-EXPORT SERIES



Foto indicativa / Indicative picture

I CAMPI DI UTILIZZO:

- Laboratori di meccanica di precisione (lavaggio minuterie)
- Laboratori di elettronica per lavaggio circuiti stampati
- Autofficine e specialisti iniezione benzina e diesel per pulitura carburatori, elettroiniettori, piccola minuteria meccanica, indotti, statori ecc.
- Carrozzerie per pulizie pistole di verniciatura

FIELDS OF APPLICATION:

- Precision mechanics workshops
- Electronic laboratories for washing printed circuits
- Car repair shops and specialist shops for fuel and diesel injection parts and for cleaning carburetors, electric injectors, small mechanic parts, armatures, stators, etc.
- Workshops for painting guns cleaning

Modelli disponibili Available models	CK 3 02.009.13	CK 6 02.009.16	CK 9 02.009.17	CK 13 02.009.24	CK 27 02.009.25
Dim. vasca / Tank size (cm)	24x14x10	30x15,5x15	30x24x15	33x30x15	50x30x20
Dim. esterne / External size (cm)	27x17x24	33x17x31	33x27x31	36x33x31	53x33x36
Capacità / Tank capacity (lt.)	3	6	9,5	13	27
Potenza ultrasuoni / U/S power	120W	180W	240W	360W	600W
Frequenza / frequency (KHz)	40	40	40	40	40
Alimentazione / Power Supply	220 V 50/60 Hz	220 V 50/60 Hz	220 V 50/60 Hz	220 V 50/60 Hz	220 V 50/60 Hz
Potenza riscaldamento (W) Heating power (W)	100W	300W	300W	400W	500W
Cestello / Basket	✓	✓	✓	✓	✓
Rubinetto di scarico Discharge valve	-	-	✓	✓	✓
Prezzo Promo / Promo Price	€ 139,00	€ 233,00	€ 283,00	€ 445,00	€ 639,00

Cod. 02.000.101 € 11,00



Tanica liquido 5411 per le vasche u/s CK EXPORT, 1 lt
Max diluizione al 10% (90% acqua)

1lt tank of 5411 liquid for CK EXPORT u/s washing tanks
Max 10% dilution (90% water)

Cod. 02.000.43 € 42,00



Tanica liquido 5411 per le vasche u/s CK EXPORT, 5 lt
Max diluizione al 10% (90% acqua)

5lt tank of 5411 liquid for CK EXPORT u/s washing tanks
Max 10% dilution (90% water)

VASCHE ULTRASUONI SERIE CK-EXPORT
ULTRASONIC WASHERS CK-EXPORT SERIES

Foto indicativa / Indicative picture

I CAMPI DI UTILIZZO:

- Applicazioni settore auto: lavaggio testate motori, cerchi in lega, particolari metallici di medie dimensioni.
- Utilizzare solo detersivi a base acquosa a temperatura $\geq 70^\circ$
- Cestello di lavaggio incluso
- Modelli su misura a richiesta

FIELDS OF APPLICATION:

- Automotive Applications: cleaning of motor parts, alloy wheels, metal parts.
- Use water based detergents only, at a temperature of $\geq 70^\circ$
- Basket included
- Special size models on request

ALTRI MODELLI SPECIALI DISPONIBILI SU RICHIESTA
OTHER SPECIAL MODELS AVAILABLE ON REQUEST

Modelli disponibili Available models	CK 800 (T-18S) 02.009.22	CK 2000 (T-36S) 02.009.23	CK 2400 (T-60S) 02.009.18	CK 3600 (T-72S) 02.009.19
Dim. vasca / Tank size (cm)	50x35x30	60x50x45	80x60x55	100x60x60
Dim.esterne / External size (cm)	57x45x65	67x60x78	92x72x88	115x72x95
Capacità /Tank capacity (lt.)	53 L	135 L	264 L	360 L
Potenza u/s / U/s power (W)	0,9 Kw	1,8 Kw	3 Kw	3,6 Kw
Frequenza / Frequency (KHz)	28	28	28	28
Alimentazione / Power Supply	220 V one phase	400 V 50Hz 3 phases	400 V 50Hz 3 phases	400 V 50Hz 3 phases
Potenza riscaldamento (W) Heating power (W)	1,5 Kw	4,5 Kw	6 Kw	9 Kw
Cestello incluso / Basket incl.	✓	✓	✓	✓
Rubinetto di scarico incluso Discharge valve included	✓	✓	✓	✓
Coperchio in acciaio inox Inox steel cover	✓	✓	✓	✓
Peso / Weight / Peso (kg)	80 kg	120 kg	205 kg	260 kg
Prezzo Promo / Promo Price	€ 1.750,00	€ 3.800,00	€ 4.800,00	€ 5.500,00

Cod. 03.036.17 € 178,00
> Vasca lavaggio da 75lt (incluso pennello)

- Con pompa elettrica 230V 50Hz
- Dimensioni imballo: 790x550x320mm
- Peso: 28 kg

> 75lts Cleaning tank (brush included)

- With electric pump 230V 50Hz
- Packaging dimensions: 790x550x320mm
- Weight 28 kgs

Cod. 02.000.96 € 110,00
> Liquido per vasca 03.036.17, 25lt
(diluizione al 50% in acqua)

> 25lt liquid
for the cleaning tank art. 03.036.17
dilution 50% in water

**CONSIGLIATO
ACQUISTO COMBINATO
SUGGESTED
COMBINED PURCHASE**

Tutte le immagini dei prodotti pubblicate in questo catalogo sono puramente indicative e possono essere cambiate senza preavviso.
All product images published in this catalogue have explanatory purposes and can be changed with no warning.

ATTREZZATURE PER LA REFRIGERAZIONE/CONDIZIONAMENTO
REFRIGERATION/AIR CONDITIONING EQUIPMENT
EQUIPO DE REFRIGERACIÓN Y AIRE ACONDICIONADO

KIT CERCAFUGHE AZOTO / IDROGENO (H2N2)
NITROGEN / HYDROGEN (H2N2) LEAK DETECTION KIT
KIT DE DETECCIÓN DE FUGAS DE NITRÓGENO / HIDRÓGENO (H2N2)

Cod. 01.000.310 € **550,00**



KIT CARRELLO PORTA BOMBOLE per servizio aria condizionata
TROLLEY KIT FOR CYLINDERS for A/C service
KIT CARRO PORTABOMBONAS para el mantenimiento A/A

IL KIT INCLUDE:

- Carrello porta bombole con ruote piene Ø 260mm (bombole esclusa)
- Tasca porta strumentazione
- Cercafughe N2H2 (01.000.203M) ①
- Manometro doppio indice ③
- Coppia attacchi LP 134/1234 ⑥ ⑦
- Tubo L=1,5 mt ¼ sae m/m ⑤
- Riduttore di pressione inlet 0-300 bar / outlet 0-60 bar ④
- Può portare una bombole (venduta separatamente) da max 10 lt/220bar

THE KIT INCLUDES:

- Cylinder trolley with inflatable wheels Ø 260mm (bottle esclusa)
- Instrument pocket
- N2H2 leak detector (01.000.203M) ①
- Double scale manometer ③
- 2 quick LP couplers 134/1234 ⑥ ⑦
- Hose L=1,5 mt ¼ sae m/m ⑤
- Pressure reducer: Inlet 0-300 bar / outlet 0-60 bar ④
- It can carry a cylinder (sold separately) of max 10lt/220bar

EL KIT INCLUYE:

- Carro portabombonas con ruedas llenas Ø 260mm (bombole no incluida)
- Compartimento portaherramientas
- Detector de fugas de N2H2 (01.000.203M) ①
- Manómetro de doble índice ③
- Pareja de acoplamiento BP 134/1234 ⑥ ⑦
- Manguera L = 1,5 mt ¼ sae m /m ⑤
- Reductor de presión de entrada 0-300 bar / salida 0-60 bar ④
- Puede llevar una bombole (vendida por separado) de un máximo de 10lt/220bar

01.000.203M	01.090.07	01.090.08.R3	01.090.08.R4	01.000.317
①	②	③	④	⑤
Cercafughe per idrogeno Hydrogen leak detector Detector de fugas de hidrógeno	Bombole azoto/idrogeno 1lt Nitrogen/hydrogen cylinder 1 lt Cilindro de nitrógeno/hidrógeno 1lt	Manometro con tubo e rubinetto Manifold gauge with hose & tap Manómetro con tubo R134a, R1234yf, R404a, R407C, R422D, R507, R22, R32, R410a	Regolatore di pressione Pressure regulator Regulador de presión	Tubo giallo 1,5 m Fx F ¼ SAE 180° Yellow hose 1,5 m Fx F ¼ SAE 180° Manguera amarilla 1,5 m Fx F ¼ SAE 180°
01.000.312	01.000.314	01.090.08.R1	01.000.318	01.000.311.R1
⑥	⑦	⑧	⑨	⑩
Attacco rapido LP ¼ SAE con rubinetto per R134a LP quick coupler ¼ SAE with tap for R134a Acoplamiento rápido LP ¼ SAE con grifo para R134a	Attacco rapido LP ¼ SAE con rubinetto per R1234yf LP quick coupler ¼ SAE with tap for R1234yf Acoplamiento rápido LP ¼ SAE con grifo para R1234yf	Riduttore bombole 1 lt 1 lt cylinder reduction 1 lt cilindro reductor	Adattatore M1/4 SAE per M1234yf – M12x1,5 Adapter M1/4 SAE x M1234yf – M12x1,5 Adaptador M1/4 SAE para M1234yf – M12x1,5	Regolatore di pressione fino 20 bar per bombole non ricaricabili Pressure regulator up to 20 bar for non-refillable cylinders Regulador de presión hasta 20 bar para cilindros no rellenables

Tutte le immagini dei prodotti pubblicate in questo catalogo sono puramente indicative e possono essere cambiate senza preavviso.
All product images published in this catalogue have explanatory purposes and can be changed with no warning.

Cod. 01.000.225

€ 427,⁰⁰

ADVANCE KIT



KIT CERCAFUGHE PER IMPIANTI A/C R134A/R1234YF e refrigerazione con miscela N2-H2 (95%/5%) e cercafughe elettronico

LEAK DETECTION KIT FOR A/C R134A AND R1234YF SYSTEMS and refrigeration systems with a N2-H2 mix (95%/5%) and electronic leak detector

KIT DETECTOR DE FUGAS PARA SISTEMAS DE A/A R134/HFO1234YF y sistemas de refrigeración con una mezcla de N2-H2 (95%-5%) y detector de fugas electrónico

IL KIT INCLUDE:

1. Cercafughe per H2 (2gr/annuo)
2. Bombola da 950cc N2-H2
3. Manometro doppia scala
4. Regolatore di pressione (300 bar)
5. Tubo di collegamento
6. Raccordo BP R134a
7. Raccordo BP R1234yf
8. Riduttore per bombola

THE KIT INCLUDES:

1. Leak detector for H2 (2gr/yearly)
2. 950cc N2-H2 cylinder
3. Double scale gauge
4. Pressure regulator (300 bar)
5. Connecting hose
6. LP coupling R134a
7. LP coupling R1234yf
8. Reducer for cylinder

EL KIT INCLUYE:

1. Detector de fugas H2 (2gr / año)
2. Cilindro 950cc N2-H2
3. Manómetro de doble escala
4. Regulador de presión (300 bar)
5. Tubo de conexión
6. Acoplam. LP R134a
7. Acoplam. LP R1234yf
8. Reductor para cilindro

Cod. 01.090.08

€ 265,⁰⁰

Kit pressurizzazione impianti con bombola azoto-idrogeno N2-H2

Come cod. 01.000.225, ma senza il cercafughe per idrogeno H2

Pressurization systems kit with nitrogen-hydrogen N2-H2

Same as cod. 01.000.225, but without the leak detector for hydrogen H2

Kit para presurización de sistemas con nitrógeno-hidrógeno N2-H2

Lo mismo que el cod. 01.000.225, pero sin el detector de fugas para H2

Cod. 01.000.311

€ 172,⁰⁰

BASIC KIT



KIT CERCAFUGHE PER IMPIANTI A/C R134A/R1234YF

solo per bombole non ricaricabili (150ml, 2200 ml - 110 bar)

LEAK DETECTION KIT FOR A/C R134A AND R1234YF SYSTEMS

only for non-refillable cylinders (150 ml, 2200 ml - 110 bar)

KIT DETECTOR DE FUGAS PARA SISTEMAS DE A/A R134/HFO1234YF

solo para cilindros no recargables (150 ml, 2200 ml - 110 bar)

IL KIT INCLUDE*:

- Bombola N2H2 950 ml, non ricaricabile (2)
- Manometro doppia scala con tubo e rubinetto (3)
- Tubo, 80cm, ¼ SAE FF (5)
- Coppia attacchi rapidi ¼ SAE R134a (LP) - R1234yf (LP) (6) (7)
- Riduttore per bombola (8)
- Riduttore di pressione fino a 20 bar per bombole da 1 lt (10)

THE KIT INCLUDES*:

- N2H2 950 ml cylinder, not refillable (2)
- Double scale pressure gauge with hose and tap (3)
- Tube, 80cm, ¼ SAE FF (5)
- Quick couplings ¼ SAE R134a (LP) - R1234yf (LP) (6) (7)
- Cylinder reduction (8)
- Pressure reducer up to 20 bar for 1 lt cylinders (10)

EL KIT INCLUYE*:

- Cilindro N2H2 de 950 ml, no recargable (2)
- Manómetro de doble escala con manguera y grifo (3)
- Tubo, 80 cm, ¼ SAE FF (5)
- Acoplamientos rápidos ¼ SAE R134a (LP) - R1234yf (LP) (6) (7)
- Reductor para cilindro (8)
- Reductor de presión hasta 20 bar para cilindros de 1 litro (10)



Cod. 01.000.203M

€ 162,00

Cercafughe Elettronico **N2-H2 MULTI REFRIGERANTE** (CFC, HCFC, HFO1234YF, R134A, N2-H2)
MULTI REFRIGERANT N2-H2 Electronic Leak Detector (CFC, HCFC, HFO1234YF, R134A, N2-H2)
Detector de fugas electronico **N2-H2 MULTI-REFRIGERANTE** (CFC, HCFC, HFO1234YF, R134A, N2-H2)

Cod. 01.000.203.R1

€ 70,00

Sensore per cercafughe Multirefrigerante (Ricambio for Cod. 01.000.203M)
Multi Refrigerant Leak Detector **sensor** (Spare part for Cod. 01.000.203M)
Sensor para detector de fugas electronico Multirefrigerante (Pieza de repuesto para Cod. 01.000.203M)

Cod. 01.090.07

€ 26,00

Bombola con miscela azoto-idrogeno N2-H2 (95%/5%), 950cc. Non ricaricabile.
Nitrogen-Hydrogen N2-H2 Cylinder (95%/5%), 950cc. Not rechargeable.



Cod. 01.090.15

€ 238,00

Bombola ricaricabile da 5 lt
di azoto-idrogeno N2-H2 (95%/5%), 200bar
5 lt Refillable Nitrogen-Hydrogen N2-H2 Cylinder
(95%/5%), 200 bars



Cod. 01.090.13

€ 47,00

Bombola da 2 lt con miscela azoto-idrogeno N2-H2 (95%/5%), 110 bar. Non ricaricabile.
2 lt Nitrogen-Hydrogen N2-H2 Cylinder (95%/5%), 110 bars. Not rechargeable.

Cod. 01.090.16

€ 360,00

Bombola ricaricabile da 10 lt
di azoto-idrogeno N2-H2 (95%/5%), 200bar
10 lt Refillable Nitrogen-Hydrogen N2-H2 Cylinder
(95%/5%), 200 bars

Cod. 01.000.100

€ 78,60



Cercafughe elettronico a LED,
per refrigeranti R134a, R22,
R404

LED electronic leak detector
for R134a, R22, R404
refrigerant

Detector electrónico de fugas

LED para refrigerantes R134a,
R22, R404

Cod. 01.000.08IMP

€ 38,00

R134a



Coppia attacchi rapidi per **R134a**,
con rubinetto

Rapid couplings for **R134a**,
with taps

Cod. 01.000.168IMP

€ 59,00

HF01234yf



Coppia attacchi rapidi per **R1234yf**,
con rubinetto

Rapid couplings for **R1234yf**,
with taps

Cod. 05.090.73

€ 16,10



KIT SMONTAGGIO VALVOLE IMPIANTI A/C CON INSERTI PENTALOBATI
KIT FOR DISASSEMBLING VALVES ON A/C SYSTEMS WITH FIVE-POINT BITS

Utile per lo smontaggio dei tappi in plastica e della
valvola interna su impianti di aria condizionata.

Useful for the disassembly of the plastic caps and the
internal valve of air conditioning installations.

IL KIT INCLUDE:

- 2 bussole femmina ottagonali
- 2 chiavi a forchetta 2,2mm/3,2mm
- 1 porta inserti 1/4"
- Kit di 7 inserti pentalobati
(TS10, TS15, TS20, TS25, TS27, TS30, TS40)

IL KIT INCLUDE:

- 2 socket female octagonal wrenches
- 2 open-ended spanners 2.2mm/3.2mm
- 1 bit holder 1/4 "
- Kit of 7 five-lobed inserts
(TS10, TS15, TS20, TS25, TS27, TS30, TS40)

Cod. 01.090.04 € 63,00



Gruppo manometrico a 4 vie con 3 tubi
L=150mm e valigetta di trasporto
(scale R22-R134a-R407c-R410a)

Four-way **manometric group** with 3 hoses
L=150mm and transport case
(for R22-R134a-R407c-R410a)

Grupo manométrico de 4 vías con 3 mangueras
L = 150mm (rojo, azul, amarillo) y caja de
transporte (para gas R22-R134-R407c-R410a)

Cod. 01.090.00 € 63,00

Per/for/para R22-R134a-R404c-R407a)

Cod. 01.090.12 € 95,00

Gruppo manometrico a 4 vie per HF01234yf
Four-way manometric group for HF01234yf
Grupo manométrico de 4 vías para HF01234yf

Cod. 01.017.05 € 976,00

BIG OIL-LESS
R134a/R1234yf

RECUPERATORE GAS. Motore brushless DC ¼ HP, indicatore di pressione digitale, monopistone, compressore oil-less, raffreddato ad aria, separatore olio, motore antiscintilla.
Dimensioni 450x250x365, peso 14,7Kg

GAS RECOVERY UNIT. Brushless DC motor ¼ HP, digital pressure gauge, single piston. **aircooled, oil-less compressor, oil separator, anti-spark engine.** Dimensions: 304x202x260mm, weight: 7,8kg

Cod. 01.017.06 € 837,00

SMALL DIGIT
R134a/R1234yf

RECUPERATORE GAS. Motore brushless DC ¼ HP, indicatore di pressione digitale, monopistone, funzione spurgo automatico.
Dimensioni 304x202x260mm, peso 7,8Kg

GAS RECOVERY UNIT. Brushless DC motor ¼ HP, digital pressure gauge, single piston, automatic purge function
Dimensions: 304x202x260mm, weight: 7,8kg

Cod. 01.000.214 € 182,00



Bilancia elettronica,
alimentazione batteria 9V.
Portata: 100Kg

Electronic scale, 9V battery
power supply. Capacity:100Kg

Balanza electrónica,
con alimentacion bateria 9V.
Capacidad: 100Kg

Cod. 01.000.319 € 10,80



Adattatori per lavaggio tubi interni e esterni per stazioni clima R134a
Adapters for washing of internal and external hoses for R134a A/C stations

Cod. 01.000.320 € 12,80



Adattatori per lavaggio tubi interni e esterni per stazioni clima R1234yf
Adapters for washing of internal and external hoses for R1234yf A/C stations

Cod.01.090.10 € 76,00

Kit Flangiatubi
Flaring Tool Set
Juego de brida de la tubería



Flangiatubi / Flaring / Ensanchador: Ø 6, 8, 10, 12, 16, 19 mm,

Misura tubi / ube size / Diametro del tubo:
1/4", 5/16", 3/8", 5/8", 3/4"

Tagliatubi / Tube cutter / Cortador de tubos:
1/8" ÷ 1.1/8" (4-28mm)

Cod. 01.090.11 € 18,00



Tagliatubi: 1/8" ÷ 1.1/4" (4-32mm)

Tube Cutter: 1/8" ÷ 1.1/4" (4-32mm)

Cortador de tubos: 1/8" ÷ 1.1/4" (4-32mm)

Cod. 01.090.01 € 325,00



Pompa a vuoto bistadio 220V, 50Hz con maniglia, vacuometro e elettrovalvola, portata **170 lt/min**, raccordi 1/4 SAE-3/8 SAE

Dual stage vacuum pump 220V 50Hz with handle, vacuumeter and electro-valve, capacity: **170 lt/min**, 1/4 SAE-3/8 SAE couplings

Bomba de vacío de doble etapa 220V 50Hz con mango, vacuómetro y electroválvula, capacidad: **170lt/1'**, acoplamientos SAE 1/4 SAE-3/8



Cod. 01.000.267 € 42,60

KIT MANUTENZIONE ANNUALE STAZIONI A/C SPIN
(ESCL. ASTRABUS)

ANNUAL MAINTENANCE KIT FOR SPIN A/C STATIONS
(EXCL. ASTRABUS)

IL KIT INCLUDE:

- 0,5 lt olio per pompa a vuoto
- 1 filtro deidratatore 1/4 SAE
- 10 guarnizioni per tubi refrigerante

THE KIT INCLUDES:

- vacuum pump oil, 0,5 lt
- 1/4 SAE dehydrator filter
- 10 gaskets for refrigerant hoses



Cod. 01.000.39 € 18,90

21CR (RL 100)
>Olio POE 100, 1 lt
>POE 100 Oil, 1 lt



Cod. 01.000.252 € 20,90

PAG PREMIUM
>Olio PAG PREMIUM, 1 lt,
per impianti R134a/HF01234yf
>PAG PREMIUM Oil, 1 lt,
for R134a/HF01234yf a/c systems



Cod. 01.000.253 € 23,90

PAG PREMIUM + ADDITIVE
>Olio PAG PREMIUM con ADDITIVO, 1 lt,
per impianti R134a/HF01234yf
>PAG PREMIUM Oil with ADDITIVE, 1 lt,
for R134a/HF01234yf a/c systems



Cod. 01.000.254 € 22,00

ADDITIVE
>Additivo universale, 250 ml,
per impianti R134a/HF01234yf
>Universal additive, 250 ml,
for R134a/HF01234yf a/c systems



Cod. 01.000.255 € 22,70

ADDITIVE
> Kit 12 siringhe, 7,5 ml con l'additivo universale
+ 2 adattatori (R134a /HF01234yf)
>Kit 12 syringes, 7.5 ml with the universal additive
+ 2 adapters (R134a / HF01234yf)



Cod. 01.000.37 € 8,40

AV 68R
>Olio per pompa a vuoto, 0,5 lt
>Vacuum pump oil, 0,5 lt



Cod. 01.000.242 € 27,50

COOL-SHOT ULTRA
>ADDITIVO per impianti di refrigerazione e condizionamento
>PERFORMANCE ENHANCER for air conditioning and
refrigeration systems



Cod. 01.000.241 € 29,50

EXTREME ULTRA
>TURAFALLE ad alte prestazioni per impianti A/C
>High performance innovative LEAK STOP for vehicles
A/C system

HYBRID



Cod. 01.000.125 € 29,50

21CR POE100
>Olio per compressori IBRIDI, 1lt
>Oil for HYBRID compressors, 1lt



Cod. 01.000.124 € 29,90

ADDITIVE
>Tracciante fluorescente U/V per impianti A/C vetture
IBRIDE, 350 ml, senza solventi
>U/V leak detector dye for A/C systems
for HYBRID vehicles, 350 ml, solvent free



Cod. 01.000.127 € 38,50

ADDITIVE
>Tracciante fluorescente U/V per impianti A/C vetture
IBRIDE, 12 x 7,5 ml, con adattatore, senza solventi
>U/V leak detector dye for A/C systems for HYBRID
vehicles, 12 x 7,5 ml, with adapter, solvent free



Cod. 01.000.167 Prezzo a richiesta
Price on request

>Refrigerante R134a
in bombole da 12 kg ricaricabili
>Refrigerant R134a (refillable 12 kg bottles)
secondo disponibilità/according to the availability



Cod. 01.000.01 € 4,20

>Adattatore 1/4 SAE per collegare la stazione A/C con la
bombola gas R134a
>Adapter for freon bottles 1/4 SAE to connect
the station to the R134a bottle



Cod. 01.000.207 € 5,00

>Adattatore alta pressione 1/4F SAE per collegamento
bombola ricaricabile R134a
>High pressure adapter 1/4F SAE for the rechargeable
R134a bottle



Cod. 01.000.187 Prezzo a richiesta
Price on request

>Bombola ricaricabile per HF01234yf con 5 kg di gas,
attacco rapido incluso
>Refrigerant HF01234yf in refillable 5 kg bottle, rapid
coupling included
secondo disponibilità/according to the availability



Cod. 01.000.208 € 9,90

>Adattatore per bombola ricaricabile HF01234yf
>Adapter for the HF01234yf bottle

Tutte le immagini dei prodotti pubblicate in questo catalogo sono puramente indicative e possono essere cambiate senza preavviso.
All product images published in this catalogue have explanatory purposes and can be changed with no warning.

PRAESIDIUM SALUTIS

PRODOTTI PER LA SANIFICAZIONE E PROTEZIONE PERSONALE
SANITATION AND PERSONAL PROTECTION PRODUCTS

SANITAZIONE

#ozonizzatori
#nebulizzatori
#atomizzatore



#lampade uv
#box uv

#mascherine
#barriere protettive
#dispenser
sanificanti



#purificatori d'aria
#liquidi disinfettanti



#termometri
#vasche u/s



Tutte le immagini dei prodotti pubblicate in questo catalogo sono puramente indicative e possono essere cambiate senza preavviso.
All product images published in this catalogue have explanatory purposes and can be changed with no warning.

Cod. 01.000.308

€ 435,00

GENERATORE DI "NEBBIA" IGIENIZZANTE per ambienti civili e automotive
SANITIZING "FOG" GENERATOR for civil and automotive environments
GENERADOR DE "NIEBLA" DESINFECTANTE para entornos civiles y automotive



IL PIÙ RAPIDO SISTEMA IGIENIZZANTE PER GRANDI AMBIENTI!!!

THE FASTEST SANITIZING SYSTEM FOR LARGE ROOMS!!!



CARATTERISTICHE TECNICHE

- Capacità erogazione: 500 m³/min
- Preriscaldamento: 6 min
- Alimentazione: 240V 50Hz
- Potenza: 1000W
- Cavo comando a distanza: 9 mt
- Dimensioni: 385x270x247mm
- Peso: 5,8 kg
- Serbatoio: 1,35 lt

• Bassi costi di sanificazione € 1,15 per ogni minuto di lavoro

• Dotato di telecomando a distanza (9 metri)

• È possibile operare anche in presenza di persone addette e/o animali

• L'attrezzo deve essere usato solo da personale professionale e addestrato

• Il dispositivo è per un uso intermittente

• Il livello del liquido necessario deve essere controllato prima di ogni sanificazione

• Un operatore professionale deve essere presente durante il trattamento, l'unità non deve restare incontrollata

• Lasciare l'apparecchio con almeno 50cm da persone o cose attorno

TECHNICAL FEATURES

- Supply capacity: 500 m³/min
- Warm-up time: 6 min
- Power supply: 240V 50Hz
- Power: 1000W
- Remote control cable: 9 mt
- Dimensions: 385x270x247mm
- Weight: 5.8 kg
- Tank capacity: 1.35 lt

• Low sanitation costs: € 1.15 per minute of work

• It is also possible to operate in the presence of personnel and/or animals

• The tool must only be used by professional and trained personnel

• The device is for intermittent use

• The level of the necessary liquid must be checked before each sanitization

• A professional operator must be present during the treatment, the unit must not remain uncontrolled

• Leave the device with at least 50cm from people or things around

Cod. 01.000.309

€ 66,50

LIQUIDO IGIENIZZANTE, 5LT
SANITIZING LIQUID, 5LT
LÍQUIDO HIGIENIZANTE, 5LT



PROTEZIONE PER IL VISO • FACE SHIELD

Cod. 01.000.279

€ 1,95



- Protezione per il viso
- Fornisce una visione chiara
- Buona funzione anti-appannamento
- Misura: 32x22 cm
- Weight: 39 gr
- Min. ordine 10 pz*
- non sterilizzata

- Face shield
- Provides a clear view
- Good anti-fog function
- Dimension: 32x22 cm
- Weight: 39 gr
- Min. order 10 pcs*
- not sterilized

Tutte le immagini dei prodotti pubblicate in questo catalogo sono puramente indicative e possono essere cambiate senza preavviso.
All product images published in this catalogue have explanatory purposes and can be changed with no warning.

Cod. 01.000.281

€ 159,⁰⁰**NEBULIZZATORE ELETTRICO A BATTERIA, 16 L**
ELECTRIC BATTERY-OPERATED SPRAYER, 16 L

- Batteria al litio rimovibile: 18 V 2,5 Ah
- Pressione di esercizio: 5 bar
- Orario di lavoro: 100 min
- Tempo di ricarica: 150 min
- Cinturino comodo
- Grilletto pesante
- Lancia di metallo
- Dimensioni imballo: 36,5x27x55 cm
- Peso: 3,5 kg
- **INCLUSO: CARRELLO COD. 01.000.281/C**

- Removable lithium battery: 18V 2,5 Ah
- Working pressure: 5 bar
- Working time: 100 min
- Charging time: 150 min
- Comfortable strap
- Heavy duty trigger
- Metal lance
- Pack. dimensiones: 33x57x20cm
- Weight: 3,5kg
- **INCLUDED: TROLLEY COD. 01.000.281/C**



Cod. 01.000.278

€ 34,⁰⁰**NEBULIZZATORE PORTATILE, 16 L**
PORTABLE SPRAYER, 16 L

- Nebulizzatore portatile da 16 lt di capacità con pompa a mano e sonda in fibra di vetro
- Portable 16 liter capacity nebulizer with hand pump and fiberglass probe

PRODOTTO CONSIGLIATO
RECOMMENDED PRODUCTCod. 01.000.280 € 31,⁵⁰**SaniBact**

> Disinfettante, 1L

Diluito in acqua 1:25

> Liquid disinfectant, 1L

Diluted in water 1:25



Num. Reg. Min. 20145

Tutte le immagini dei prodotti pubblicate in questo catalogo sono puramente indicative e possono essere cambiate senza preavviso.
All product images published in this catalogue have explanatory purposes and can be changed with no warning.

Prezzi promozionali / IVA e trasporto non incluso • Promotional prices • Precios promocionales



Cod. 01.000.283E

€ 282,00

PUREZONE HOME

ATOMIZZATORE PER LA DISINFEZIONE DI AMBIENTI
DESINFECTATION ATOMIZER FOR ROOMS



CARATTERISTICHE TECNICHE

- Touch screen LCD
- Capacità: 13L
- Timer fino 12 ore
- Selezione dimensione gocce
- Selezione grado di umidità richiesto
- Quantità di nebulizzazione: ≤ 1800 ml / h
- Area di applicazione: 80-120m²
- Telecomando
- Dimensioni: 30x39x60cm
- Peso: 5 kg

TECHNICAL FEATURES

- LCD touch screen
- Tank capacity: 13L
- Timer: up to 12 h
- Adjustable droplet dimension
- Humidity level selection
- Nebulization quantity: ≤ 1800 ml / h
- Application area: 80-120m²
- Remote control
- Dimensions: 30x39x60cm
- Weight: 5 kg

PUREZONE HOME Kit include:

- 10lt di liquido igienizzante **ECASAN**, diluibile al 50% in acqua demineralizzata

PUREZONE HOME Kit includes:

- 10lt of sanitizing liquid **ECASAN**, 50% dilution in demineralized water

Cod. 01.000.306

€ 49,00

ECASAN

- > Liquido sanificante per atomizzatore, 5 lt
- > Hygienizing liquid for u/s atomizer 5 lt



5+5 LT
INCLUSI



ATOM MACHINE

ATOM MACHINE is an electronic ultrasound device that instantly generates the nebulization of a sanitizing liquid that propagates in the environment and in the recirculation system of the A/C system to be sanitized by hygienisation of the air and all the surfaces present.

The main feature of the Ultrasonic Nebulization System consists in obtaining atomized particles of liquid at room temperature, avoiding the phenomenon of condensation that occurs differently when a liquid is atomized by heating. The ATOM ULTRA particles thus obtained have a size of less than 5 μm and perfectly propagate in the environment and in the A / C system.

A sanitizing treatment cycle with ATOM ULTRA lasts about 30 minutes at 20°C and stops automatically.

The exposure time has been studied to ensure that an environment of 20 m² or all parts of the system are reached, the environment is saturated and the active ingredients have the right contact time to guarantee good sanitation.

ATOM MACHINE KIT includes:

- ATOM MACHINE nebulizer
- 48 bottles ATOM ULTRA, 120 ml (lemon-scented)



Cod. 01.000.286

€ 145,00

ATOM MACHINE è un'apparecchiatura elettronica ad ultrasuoni che genera istantaneamente la nebulizzazione di un liquido igienizzante che si propaga nell'ambiente e nel sistema di ricircolo dell'Impianto A/C da igienizzare sanificando l'aria e tutte le superfici presenti.

La caratteristica principale del Sistema di Nebulizzazione per ultrasuoni consiste nell'ottenere particelle nebulizzate di liquido a temperatura ambiente, evitando il fenomeno della condensazione che si verifica diversamente quando un liquido è nebulizzato per riscaldamento. Le particelle di ATOM ULTRA così ottenute hanno una dimensione inferiore ai 5 μm e si propagano perfettamente nell'ambiente e nell'Impianto di A/C.

Un ciclo di trattamento igienizzante con ATOM ULTRA dura circa 30 minuti a 20°C e si ferma automaticamente.

Il tempo di esposizione è stato studiato per garantire che un ambiente di 20 mq o tutte le parti dell'impianto vengano raggiunte, l'ambiente venga saturato e gli attivi abbiano il giusto tempo di contatto per garantire una buona igienizzazione.

ATOM MACHINE KIT include:

- Nebulizzatore ATOM MACHINE
- 48 ricariche ATOM ULTRA da 120 ml (al profumo di limone)



Cod. 01.000.297

€ 47,00

> ATOM ULTRA ricariche al profumo di limone, (liquido sanificante per nebulizzatore Atom Machine), 12 pz x 120 ml

> ATOM ULTRA lemon-flavored refills (purifying treatment for Atom Machine nebulizer), 12 pcs x 120 ml



Cod. 01.000.286.R2

€ 32,00

> Alimentatore 220V per Atom Machine
> 220V power supply for Atom Machine



OZONIZZATORI PORTATILI
PORTABLE OZONE GENERATORS
GENERADORES DE OZONO PORTÁTILES



Esempio di calcolo tempo di sanificazione di una stanza:

$$\text{volume } 3 \times 4 \times 3 \text{ mt} = 36 \text{ m}^3$$

$$\text{Tempo: } 36/2 = 18 \text{ minuti}$$

Calculation example of the necessary time for a deep cleaning of a room: $\text{volume } 3 \times 4 \times 3 \text{ mt} = 36 \text{ m}^3$

$$\text{Time: } 36/2 = 18 \text{ minutes}$$

Ejemplo de cálculo del tiempo necesario para una limpieza profunda de una habitación: $\text{volumen } 3 \times 4 \times 3 \text{ mt} = 36 \text{ m}^3$

$$\text{Tiempo: } 36/2 = 18 \text{ minutos}$$

Cosa è l'ozono?

L'ozono (O₃) è un gas dal caratteristico odore agliaceo, le cui molecole son formate da 3 atomi di ossigeno. E' un potente agente antimicrobico che grazie alla sua azione ossidante è in grado di rendere inattivi batteri, muffe, lieviti, parassiti e virus.

Cosa può fare l'ozono?

L'azione deodorante e disinfettante dell'ozono dipende dalla sua forte capacità ossidante che a livello gassoso offre molti vantaggi. L'ozono purifica l'aria ed elimina totalmente gli odori sgradevoli.

Benefici:

- Elimina completamente gli odori dagli ambienti e dalle superfici (autoveicoli, imbarcazioni, abitazioni, celle frigorifere, ecc.)
- Efficace contro l'odore di tabacco
- Efficace contro l'odore di cibo e animali
- Uccide rapidamente tutti i microrganismi (virus, batteri, spore, muffe, parassiti e protozoi, ecc.)
- Non necessita di manutenzione ordinaria e di nessun apporto di manodopera, di nessun prodotto o materiale di consumo
- Non utilizza sostanze dannose per l'ambiente e non lascia residui (si decompone in O₂)

Applicazioni:

La bonifica degli ambienti deve essere compiuta in totale assenza di persone o animali domestici usando un ventilatore per la diffusione.

What is ozone?

Ozone (O₃) is a gas with a typical garlic-like smell whose molecules are made of 3 atoms of oxygen. It is a powerful anti-microbial that thanks to its oxidizing action it can deactivate bacteria, molds, yeasts, parasites and viruses.

What can ozone do?

The deodorizing and disinfectant action of the ozone depends on its strong oxidizing capacity which at a gaseous state offers many advantages. Ozone purifies air and eliminates any unpleasant smells.

Benefits:

- It completely eliminates odors from spaces and surfaces (vehicles, boats, houses, cold storage, etc.)
- Efficient against tobacco smell
- Efficient against food and animals smell
- It rapidly kills all microorganisms (viruses, bacteria, spores, molds)
- It does not need any ordinary maintenance or labor work, nor any product or consumables
- It does not use any substance dangerous for the environment nor it leaves any residuals (it breaks down in O₂)

Applications:

The cleaning of the environment must be carried out in total absence of people or pets and by using a fan to spread the ozone.



Cod. 01.000.299



Prezzo a richiesta
Price on request

OZONIZZATORE PORTATILE ARIA-ACQUA
AIR-WATER OZONE MAKER
OZONIZADOR PORTÁTIL AIRE-AGUA

- Idoneo sia per il trattamento dell'acqua che dell'aria. Effetto sterilizzante e deodorante.
- Tubo in silicone da un metro e 2 ugelli per il trattamento dell'acqua.
- Tubo di ozono da 2,4 g con elettrodo in acciaio inossidabile, stabile e ad alte prestazioni
- Timer di 3 ore per controllare il tempo di purificazione
- Alimentazione e pompa dell'aria incorporata: 10 l/min
- Per l'uso con acqua: posizionare l'ugello dell'aria nell'acqua per ozonizzare
- With 1 mt silicone tube and 2 air nozzles for water treatment
- Both for water and air treatment
- Portable Design: Small and compact, convenient to use anywhere
- 2.4g ozone tube with stainless steel electrode, stable and high performance
- 3 hours timer to control purification time
- Air feed and built-in air pump: 10L/min
- For water application: place the air nozzle in the water to ozonize it

Tutte le immagini dei prodotti pubblicate in questo catalogo sono puramente indicative e possono essere cambiate senza preavviso.
All product images published in this catalogue have explanatory purposes and can be changed with no warning.

OZONIZZATORI PORTATILI • PORTABLE OZONE GENERATORS • GENERADORES DE OZONO PORTÁTILES

MODELLI DISPONIBILI MODELS AVAILABLE MODELOS DISPONIBLES						
	Cod. 01.000.215	Cod. 01.000.215W	Cod. 01.000.269	Cod. 01.000.224	Cod. 01.000.224L	Cod. 01.000.257
Capacità Capacity Capacidad	3,5 gr/h	5 gr/h	4 gr/h pacco ceramico sostituibile da esterno replaceable ceramic ozone module	3,50 ÷ 7 gr/h Con potenza regolabile with adjustable power con potencia ajustable	10 gr/h	5/10/15/20 gr/h Con potenza regolabile with adjustable power con potencia ajustable
Timer Temporizador	2 ore/hours/horas	2 ore/hours/horas	3 ore/hours/horas	2 ore/hours/horas 12 ore a richiesta/hours on request horas bajo solicitud	2 ore/hours/horas	135 min con timer digitale with digital timer con temporizador digital
Rumorosità / Noisiness Ruido	<40dB	<40dB	<40dB	<40dB	<40dB	<40dB
Alloggiamento Housing Alojamiento	Cabinet in acciaio verniciato Cabinet made of painted steel Alojamiento de acero pintado	Cabinet in acciaio verniciato Cabinet made of painted steel Alojamiento de acero pintado	Cabinet in acciaio verniciato Cabinet made of painted steel Alojamiento de acero pintado	Cabinet in acciaio inossid. Stainless steel cabinet Alojamiento en acero inoxidable	Cabinet in acciaio verniciato Cabinet made of painted steel Alojamiento de acero pintado	Cabinet in acciaio inossid. Stainless steel cabinet Alojamiento en acero inoxidable
Potenza/Power/Potencia	65W	65W	50W DC/AC	100W	100W	270W
Dimensioni Dimensions Dimensiones	205x175x150 mm	205x175x150 mm	205x175x150 mm	210x180x260 mm	210x180x260 mm	202x379x285 mm
Volume flusso aria Airflow volume Volumen del flujo de aire	2,5 m ³ /min	2,5 m ³ /min	2,5 m ³ /min	2 ÷ 4 m ³ /min	2 ÷ 4 m ³ /min	4,8 m ³ /min
Peso netto-lordo Net-gross weight Peso neto-bruto	2Kg/2,6Kg	2Kg/2,6Kg	2Kg/2,6Kg	2,9Kg/3,9Kg	2,9Kg/3,9Kg	6,2Kg/7,6Kg
Alimentazione: Power supply: Alimentación:	220/240V	220/240V	BIPOWER 12V DC 120 ÷ 240V AC	220/240V	220/240V	210/230V
Trattamento aria Air treatment Tratamiento de aire	✓	✓	✓	✓	✓	✓
Telecomando Remote control Control remoto	—	—	—	—	—	✓
Prezzo promo: Promo price:	€ 84,³⁰	€ 86,⁵⁰	€ 115,⁰⁰	€ 162,⁰⁰	€ 203,⁰⁰	€ 262,⁰⁰



**Areare completamente l'ambiente
bonificato prima di accedervi**

**Ventilate completely the area after
sanification and before entering**

**Ventile completamente el área después
de la higienización y antes de entrar**



Tutte le immagini dei prodotti pubblicate in questo catalogo sono puramente indicative e possono essere cambiate senza preavviso.
All product images published in this catalogue have explanatory purposes and can be changed with no warning.

Prezzi promozionali / IVA e trasporto non incluso • Promotional prices • Precios promocionales

PROMO 2024

89

PURIFICATORE D'ARIA • UV HUMIDIFIER AIR PURIFICATIO

PURIFICATORE D'ARIA

con azione germicida a raggi uv-c

UV HUMIDIFIER AIR PURIFICATION

with germicidal action

Cod. 01.000.300

€ 299,00



AZIONE ANTIBATTERICA DEI RAGGI ULTRAVIOLETTI

su acari, muffe, batteri e virus (20 milioni di ioni/cm²).

THE ANTIBACTERIAL ACTION OF ULTRAVIOLET RAYS

on mites, molds, bacteria and viruses (20 million ions / cm²)

CARATTERISTICHE TECNICHE

- Capacità di trattamento aria: 488 m³/h
- Ideale per ambienti da 34 a 58m²
- Allarmi: filtro intasato, blocco per bambini, analizzatore pm 2.5, touch screen e WiFi standard
- Filtri interni: alluminio (lavabile), catalitico, antibatterico, carboni attivi e HEPA.
- Sterilizzatore con UV-C a 365 nm

TECHNICAL FEATURES

- Air treatment capacity: 488 m³/h
- Ideal for rooms from 34 to 58m²
- Alarms: clogged filter, child lock, pm 2.5 analyzer, touch screen and standard WiFi
- Internal filters: aluminum (washable), catalytic, antibacterial, activated carbon and hepa.
- UV-C / 365 nm sterilizer

FILTRAGGIO DELLE PARTICELLE PM 2.5 FINO AL 99,99%

PARTICLE FILTERING PM 2.5 UP TO 99.99%

Cod. 01.000.300.R1

€ 10,00

Filtro antipolline (K08EF1)

Cod. 01.000.300.R2

€ 40,00

- > 2 filtri (carboni attivi + HEPA)
- > Carbon + HEPA filters, 2 pcs

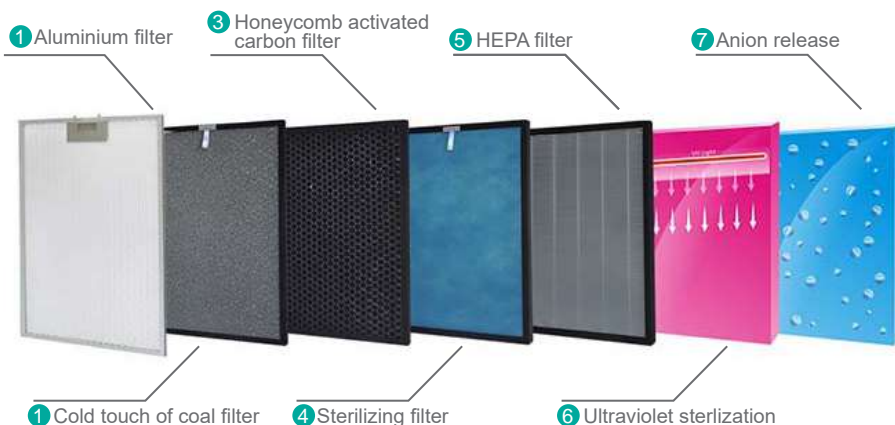

Tutte le immagini dei prodotti pubblicate in questo catalogo sono puramente indicative e possono essere cambiate senza preavviso.
All product images published in this catalogue have explanatory purposes and can be changed with no warning.



FUNZIONE "NEBULIZZATORE"
per liquidi sanificanti e/o profumanti

"NEBULIZER" FUNCTION
for sanitizing and / or perfuming liquids

- l'apparecchio è dotato di vaschetta porta liquido ad ultrasuoni per nebulizzare prodotti sanificanti e profumanti
 - con comando a distanza e 5 gradi di filtraggio) con indicatore digitale dell'intasamento
 - con comando tramite smartphone, scaricando l'app SmartLife
 - Dimensions: 400x230x620mm
 - Weight: 13.6kg
 - Power supply: 110 ÷ 265V / 50Hz 85W
- the device is equipped with an ultrasonic liquid holder to nebulize sanitizing and perfuming products
 - with remote control and 5 degrees of filtering) with digital clogging indicator
 - Use of the app SmartLife to smart control with the smartphone
 - Dimensions: 400x230x620mm
 - Weight: 13,6kg
 - Power supply: 110 ÷ 265V/50Hz 85W

Smart Life App

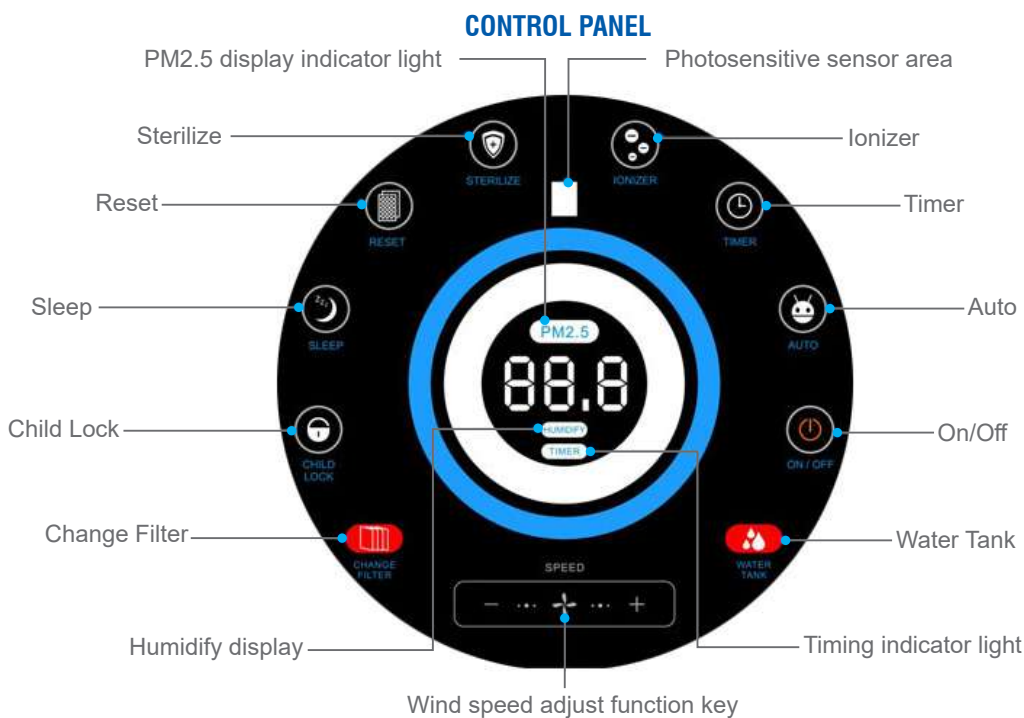

REGOLAZIONE AUTOMATICA DEL FLUSSO ARIA

a seconda del grado di contaminazione

AUTOMATIC REGULATION OF THE AIR FLOW

according to the degree of contamination



- L'ampio display riporta l'analizzatore del tasso di Pm 2.5, il timer, il pulsante attivazione uv-c, indicatori di livello dell'acqua nel serbatoio e la regolazione del flusso d'aria (automatico a seconda del livello di contaminazione rivelata (rosso – alto, giallo – medio, verde – basso)
- The large display shows the Pm 2.5 rate analyzer, the timer, the uv-c activation button, water level indicators in the tank and the air flow regulation (automatic according to the level of contamination detected (red - bad, yellow - ordinary, green - good)

Tutte le immagini dei prodotti pubblicate in questo catalogo sono puramente indicative e possono essere cambiate senza preavviso.
All product images published in this catalogue have explanatory purposes and can be changed with no warning.

Prezzi promozionali / IVA e trasporto non incluso • Promotional prices • Precios promocionales

PROMO 2024

91

DISPOSITIVI DI STERILIZZAZIONE A RAGGI UV-C • ULTRAVIOLET STERILIZATION DEVICES

Cod. 05.073.47

€ 59,⁰⁰

UV LAMP



INNOVATIVA LAMPADA DISINFETTANTE A RAGGI UV-C
INNOVATIVE UV-C DISINFECTANT LAMP

- Con 18 led, batteria ricaricabile 3,7V 2000mAh
- Idonea per sterilizzare mascherine, cellulari, tastiere, abiti, piani di lavoro, divani, letti, sanitari, gioielli, oggetti per la cura della persona
- In meno di 1 minuto abbattimento del 99,9% di batteri
- Spegnimento automatico se rivolto verso il viso o corpo
- Ricarica automatica con cavo mini USB
- 1° carica: 4-5H; autonomia 3H
- 18 LEDs, 3.7V, 2000mAh rechargeable battery
- Suitable for sterilizing masks, cell phones, keyboards, clothes, worktops, sofas, beds, sanitary ware, jewelry, personal care items
- In less than 1 minute, 99.9% killing of bacteria
- Automatic shutdown if facing towards the face or body
- Automatic charging with mini USB cable
- First charge: 4-5h; 3h autonomy



Cod. 05.073.48

€ 29,⁹⁰

UV BOX

BOX DI STERILIZZAZIONE A RAGGI UV-C
UVC LIGHT STERILIZATION BOX



- **Multifunzionale:** idoneo per smartphone, giocattoli, occhiali, spazzolini, chiavi, gioielli e piccoli oggetti.
- Agisce anche come profumatore oltre che sanificatore
- Raggi UV-C
- Il tasso battericida è fino al 99,9% utilizzando la banda d'onda di sterilizzazione ad alta efficienza UV-C 253,7nm
- Potenza totale: 6W
- Batterie ricaricabili
- Dimensioni: 227x125x50mm
- Peso: 337 gr
- **Multifunctional:** suitable for smartphones, toys, glasses, toothbrushes, keys, jewelry and small objects.
- It also acts as a perfumer as well as sanitizer
- UV-C rays
- The bactericidal rate is up to 99.9% by using high efficiency sterilization wave band UV-C 253.7nm
- Total power: 6W
- Rechargeable batteries
- Dimensions: 227x125x50mm
- Weight: 337 gr



Tutte le immagini dei prodotti pubblicate in questo catalogo sono puramente indicative e possono essere cambiate senza preavviso.
All product images published in this catalogue have explanatory purposes and can be changed with no warning.

SICUREZZA ALIMENTARE • FOOD SAFETY SYSTEM

HACCP

HAZARD ANALYSIS AND CRITICAL CONTROL POINT

Cos'è il piano HACCP?

È un insieme di documenti e regole di prevenzione da mettere in atto per ogni azienda della filiera **ALIMENTARE**.

È un elemento obbligatorio per lavorare in sicurezza e in osservanza delle normative stabilite dal regolamento CE 852/2004.

Per chi è obbligatorio il piano HACCP?

È obbligatorio per le 3 grandi categorie:

- **A: Preparazione, produzione e confezionamento** (macellerie, panifici, laboratori alimentari)
- **B: Trasporto, deposito, stoccaggio e distribuzione** (distributori automatici alimentari/bevande, magazzini, trasporto alimentari)
- **C: Commercio, somministrazione, vendita** (ristoranti/bar, supermercati, banchi di frutta etc., erboristerie e farmacie che vendono farmaci, medicine e dispositivi medicanti che necessitano di trattamento di temperature particolari)

What is HACCP?

It is a set of documents and prevention rules to be implemented for each company in the **FOOD CHAIN**.

It is a mandatory element to work in safety and in compliance with the regulations established by the EC regulation 852/2004.

For whom is the HACCP plan mandatory?

It is mandatory for the 3 main categories:

- **A: Preparation, production and packaging** (butchers, bakeries, food laboratories)
- **B: Transport, storage, storage and distribution** (food / drink vending machines, warehouses, food transport)
- **C: Commerce, administration, sale** (restaurants/bars, supermarkets, fruit shops etc., herbalists and pharmacies that sell drugs, medicines and medical devices that need to treat them under particular temperatures)

DISINFETTANTE CONCENTRATO BATTERICIDA E LEVURICIDA (NUM. REG. MIN. 20145)
LIQUID DISINFECTANT FOR SURFACES WITH BACTERICIDE AND VIRUCIDAL EFFICACY

SANIBACT, 1L



Cod. 01.000.280

€ 31,50

HACCP
PRODUCT

Num. Reg. Min. 20145

- Disinfettante **Presidio Medico Chirurgico** (Num. Reg. Min. 20145)
- Uccide germi e batteri garantendo la disinfezione profonda di evaporatori, canali di areazione e di tutte le superfici
- Efficace contro i virus di influenza, epatite B/C, HIV, rota virus, noro virus e ebola virus. Per i batteri supera i test EN1276 - EN13697. Per le muffe supera i test EN13697
- È un prodotto estremamente concentrato: necessita di una **diluizione pari a 1:25**. (con 1 Litro di Sanibact si ottengono 25 Litri di disinfettante pronto all'uso)
- Può essere utilizzato anche su superfici a contatto con alimenti (in questo caso è necessario risciacquare la superficie trattata dopo l'applicazione). **Idoneo per il piano HACCP**
- Agisce in soli 5 minuti
- Garantisce un profondo livello di disinfezione
- Disinfettante **Presidio Medico Chirurgico** (Reg. Min. 20145); reg. in Germany with authorization no. 69542; reg. in Poland with nr. 6979/17
- It kills germs and bacteria by ensuring the deep disinfection of evaporators, ventilation channels and all surfaces
- Effective against influenza viruses, hepatitis B / C, HIV, rota virus, noro virus and ebola virus. For bacteria it passes the EN1276 - EN13697 tests. For molds it passes the EN13697 tests
- It is an extremely concentrated product: it needs a **1:25 dilution**. (with 1 liter of Sanibact you get 25 liters of ready-to-use disinfectant)
- It can also be used on surfaces in contact with food (in this case it is necessary to rinse the treated surface after application). **Suitable for the HACCP plan**.
- It works in just 5 minutes
- It guarantees a deep level of disinfection



Tutte le immagini dei prodotti pubblicate in questo catalogo sono puramente indicative e possono essere cambiate senza preavviso.
All product images published in this catalogue have explanatory purposes and can be changed with no warning.

Cod. 01.000.276

13,⁰⁰

POTENTE IGIENIZZANTE A BASE DI ALCOOL 80%

per superfici in bombola spray da 400 ml - idoneo per tutte le superfici

POWERFUL 80% ALCOHOL-BASED SANITIZER

for surfaces in 400 ml spray can - suitable for all surfaces

CleanSi



CLEANSI grazie al suo elevato contenuto di alcool all'80% garantisce un profondo livello di igienizzazione. Evapora rapidamente e completamente senza lasciare residui e aloni.

E' LA SOLUZIONE IDEALE PER L'IGIENIZZAZIONE DI:

Ambienti domestici e uffici: maniglie, sedie, tavoli, tavoli in vetro, mazzi di chiavi, telecomandi e schermi TV, smartphone e tablet, console videogiochi, giocattoli, suppellettili, tasti ascensore, accessori bagno, piani di lavoro in cucina e piccoli elettrodomestici, corrimano e serramenti. E' adatto anche per la pulizia di vetri, lenti (anche di occhiali) e superfici in vetro.

Autoveicoli: spruzzato direttamente su maniglie, cruscotti, leve del cambio, volante. Filtri e condotti di ventilazione degli impianti di climatizzazione.

RIMUOVE GERMI E ALLERGENI

CleanSi rimuove germi, allergeni (provenienti da acari della polvere, cani, gatti, pollini), polvere e sporco ambientale. Può essere utilizzato anche per pulire e igienizzare filtri e condotti di ventilazione degli impianti di climatizzazione eliminando i microorganismi che pregiudicano la qualità e la salubrità dell'aria immessa negli ambienti o negli abitacoli.

RAPIDO ED EFFICACE

Il trattamento igienizzante CleanSi è rapido ed efficace e rilascia un fresco profumo di pulito. CleanSi è un prodotto idoneo per il piano HACCP, può quindi essere utilizzato anche sulle superfici a contatto con gli alimenti.

CLEANSI thanks to its high alcohol content of 80% guarantees a deep level of sanitation. It evaporates quickly and completely without leaving residues and streaks.

IT IS THE IDEAL SOLUTION FOR THE SANITATION OF:

Home environments and offices: handles, chairs, tables, glass tables, bunches of keys, remote controls and TV screens, smartphones and tablets, video game consoles, toys, furnishings, elevator keys, bathroom accessories, kitchen worktops and small appliances, handrails and frames. It is also suitable for cleaning glass, lenses (including glasses) and glass surfaces.

Vehicles: sprayed directly on handles, dashboards, shift levers, steering wheel.

Filters and ventilation ducts of air conditioning systems.

REMOVES GERMS AND ALLERGENS

CleanSi removes germs, allergens (from dust mites, dogs, cats, pollens), dust and environmental dirt. It can also be used to clean and sanitize filters and ventilation ducts of air conditioning systems by eliminating microorganisms that affect the quality and healthiness of the air introduced into the rooms or interiors.

QUICK AND EFFECTIVE

The CleanSi sanitizing treatment is quick and effective and releases a fresh clean scent. CleanSi is a product suitable for the HACCP hob, therefore it can also be used on surfaces in contact with food.



Tutte le immagini dei prodotti pubblicate in questo catalogo sono puramente indicative e possono essere cambiate senza preavviso.
All product images published in this catalogue have explanatory purposes and can be changed with no warning.

PRODOTTI PER IL LAVAGGIO E LA MANUTENZIONE DI SPLIT PER ARIA CONDIZIONATA PRODUCTS FOR WASHING AND MAINTENANCE OF A/C SPLITS

Cod. 01.000.282 € 12,⁹⁵ CHINOOK, 1L

PULITORE PER FILTRI A/C UNITÀ INTERNE CLEANER FOR INDOOR A/C FILTERS

É un efficace pulitore per i filtri di qualsiasi tipo di unità interna, non aggressivo per i loro materiali. Pulisce in modo rapido ed efficace, rimuovendo facilmente smog, polvere, muffe e contaminanti microbici e lasciando un piacevole profumo di pulito.

It is an effective cleaner for filters of any type of indoor unit, non-aggressive for their materials. It cleans quickly and effectively, easily removing smog, dust, mold and microbial contaminants and leaving a pleasant clean scent.



Cod. 01.000.284 € 12,²⁹ LUXEDO, 1L

PULITORE IGIENIZZANTE PROFUMATO per climatizzatori e superfici, 1L SCENTED SANITIZING CLEANER for air conditioners & surfaces, 1L

- Rimuove germi, batteri e allergeni
- Rimuove residui organici, sporco ambientale e grasso
- Disinfettante registrato in Germania (N° 69541)
- Non necessita di risciacquo
- Profumato
- Removes germs, bacteria and allergens
- Removes organic residues, environmental dirt and grease
- German Registered Disinfectant (No. 69541)
- It does not require rinsing
- Scented



Cod. 01.000.294 € 15,⁵⁷ WALLY

COVER PER PULIZIA MINI-SPLIT MINI-SPLIT CLEANING COVER



- WALLY è una cover in Polietilene (PE) trasparente riutilizzabile che assicura la completa protezione dell'area attorno allo split durante le operazioni di pulizia.
- Grazie a WALLY il tecnico può pulire l'evaporatore e le sue batterie alettate con un disassemblaggio minimo, lasciando lo split a muro.
- La coulisse, infatti, garantisce la perfetta aderenza sui climatizzatori a parete di qualsiasi dimensione.
- Cleaner, acqua di risciacquo e sporco defluiscono nel secchio (non fornito), senza rischiare di danneggiare le superfici circostanti.

- WALLY is a reusable transparent polyethylene (PE) cover that ensures complete protection of the area around the split during cleaning.
- Thanks to WALLY, the technician can clean the evaporator and its finned batteries with minimal disassembly, leaving the wall split.
- The drawstring, in fact, guarantees perfect adherence to wall mounted air conditioners of any size.
- Cleaner, rinse water and dirt will flow into the bucket, without risking damaging the surrounding surfaces.



Tutte le immagini dei prodotti pubblicate in questo catalogo sono puramente indicative e possono essere cambiate senza preavviso.
All product images published in this catalogue have explanatory purposes and can be changed with no warning.

BARRIERE ANTICONTAMINAZIONE BATTERICA per uffici, farmacie e pubblici esercizi
BACTERIAL CONTAMINATION BARRIERS for offices (open spaces), pubs, restaurants etc.

Modelli disponibili Available models	Cod. 05.088.114	Cod. 05.088.115 	Cod. 05.088.116	Cod. 01.000.295 
Dimensioni	1200x800 mm	1000x600 mm	750x660 mm	500x700 mm
Spessore Thickness	5 mm	4 mm	4 mm	4 mm
Foro passa fogli	✓	✓	✓	✓
Min. ordine Min. order	5 pz / pcs* indivisibili non-divisible	1 pz	12 pz / pcs* indivisibili non-divisible	5 pz / pcs* indivisibili non-divisible
Prezzo Promo Promo Price	€ 268,00*	€ 72,00	€ 370,00*	€ 195,00*

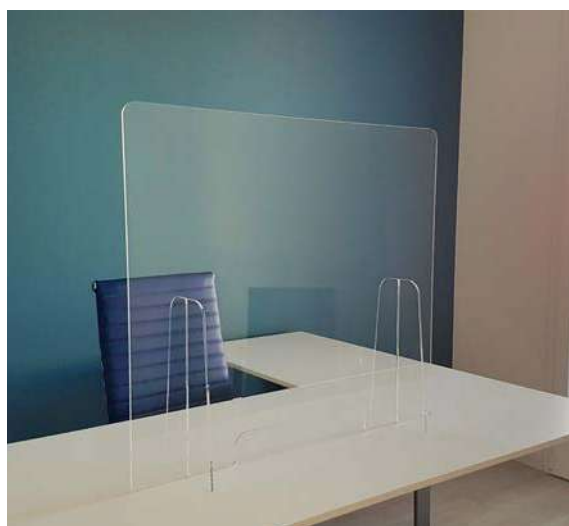

Cod. 01.000.296 € **68,00**

> Barriera anticontaminazione batterica in acetato e cartone pressato (struttura 580x780 mm; schermo 467x620 mm).

Min. ordine: 10 pz indivisibili*

> Transparent ROLL-UP barrier in acetate for separating entrances to passage areas / corridors (1000 x 2000 cm)

Min. order: non divisible 10 pcs*



Cod. 05.088.117 € **80,00**

> Barriera ROLL-UP trasparente in acetato per separazione ingressi aree di passaggio/corridoi (1000 x 2000 cm)

> Transparent ROLL-UP barrier in acetate for separating entrances to passage areas / corridors (1000 x 2000 cm)

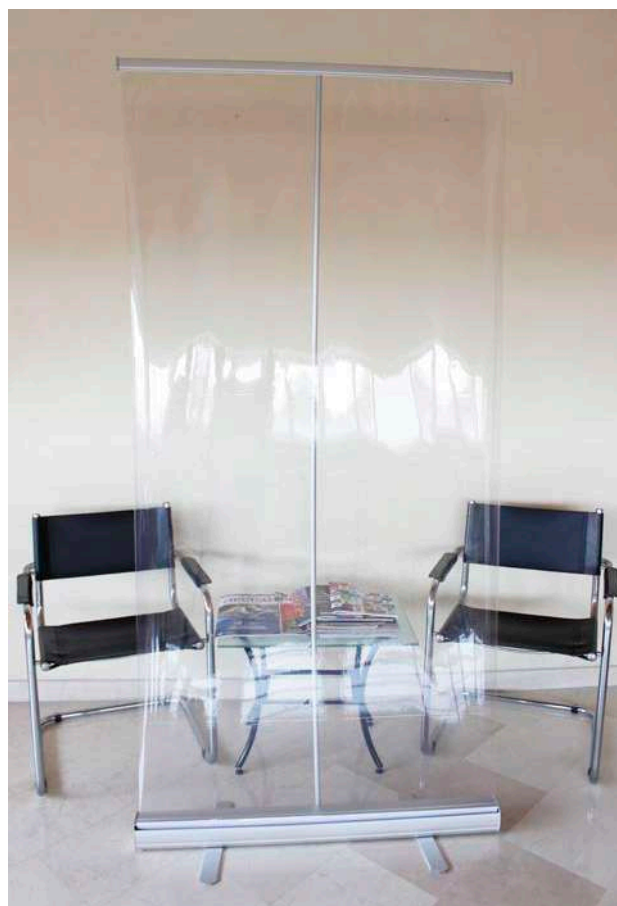

Cod. 04.052.06

€ 75,00

Prezzi netti per quantità
Net prices for min. q.ty**TERMOMETRO FRONTALE A PISTOLA (CORPO / SUPERFICI)**

digitale a infrarossi senza contatto

FRONTAL GUN THERMOMETER (BODY / SURFACE)

digital, with infrared, contactless

TERMÓMETRO PISTOLA FRONTAL (CORPORAL / SUPERFICIAL)

digital, con infrarrojos, sin contacto

- Temperatura di allarme automatica di $\geq 38^\circ\text{C}$
- **Conforme EN 61000-6-1:2007, EN 61000-6-3:2007, A1:2011**
- Display grande, retroilluminato
- Velocità della misurazione: 0,5 secondi
- Distanza di misurazione: 5-15 cm
- Dimensioni del prodotto: 160x100x40mm
- Peso: 100g
- 2 batterie AAA (non incluse)

- Automatic alarm temperature at $\geq 38^\circ\text{C}$
- **Compliant w. EN 61000-6-1:2007, EN 61000-6-3:2007, A1:2011**
- Large backlit display
- Time measurement sensitivity: 0.5 seconds
- Distance measurement: 5-15 cm
- Product dimensions: 160x100x40mm
- Weight: 100g
- 2 x AAA batteries (not included)

- Alarma automática de temperatura a $\geq 38^\circ\text{C}$
- **Conforme con EN 61000-6-1:2007, EN 61000-6-3:2007, A1:2011**
- Pantalla grande retroiluminada
- Sensibilidad medición tiempo: 0.5 segundos
- Medida de distancia: 5-15 cm
- Dimensiones del producto: 160x100x40mm
- Peso: 100g
- 2 x pilas AAA (no incluidas)



temperatura CORPO / SUPERFICI
BODY / SURFACE temperature
temperatura CORPORAL / SUPERFICIAL



Cod. 04.013.05

€ 30,00

TERMOMETRO DIGITALE A RAGGI INFRAROSSIcon puntatore laser ($-50^\circ/+400^\circ$)**DIGITAL INFRARED THERMOMETER**with laser pointer ($-50^\circ/+400^\circ$)**TERMÓMETRO DIGITAL DE RAYOS INFRARROJOS**con puntador laser ($-50^\circ/+400^\circ$)

- | | | |
|---|--|---|
| • Misura della temperatura senza contatto | • Non-contact temperature measurement | • Medición de la temperatura sin contacto |
| • Spegnimento automatico | • Auto Power Off | • Apagado automático |
| • Grado di emissività regolabile 0,95 (fisso) | • Adjustable emissivity: from 0,95 (fixed) | • Grado de emisión regulable 0,95 (fijo) |
| • Rapporto distanza-dimensioni: 12:1 | • Distance spot ratio: 12:1 | • Relación distancia-dimensiones: 12:1 |
| • Data hold | • Data hold | • Data hold |



Cod. 04.052.00

€ 5,95

TERMOMETRO DIGITALE A PENNA $-50^\circ/+150^\circ\text{C}$ **DIGITAL PEN THERMOMETER $-50^\circ/+150^\circ\text{C}$** **TERMÓMETRO TIPO BOLÍGRAFO DIGITAL $-50^\circ/+150^\circ\text{C}$** 

Tutte le immagini dei prodotti pubblicate in questo catalogo sono puramente indicative e possono essere cambiate senza preavviso.
All product images published in this catalogue have explanatory purposes and can be changed with no warning.

Prezzi promozionali / IVA e trasporto non incluso • Promotional prices • Precios promocionales

PROMO 2024

97

**ATTREZZATURE PER GOMMISTI
TYRE SHOP EQUIPMENT
EQUIPO DE TIENDA DE NEUMÁTICOS**



Tutte le immagini dei prodotti pubblicate in questo catalogo sono puramente indicative e possono essere cambiate senza preavviso.
All product images published in this catalogue have explanatory purposes and can be changed with no warning.

Cod. 03.001.06

€ 990,00

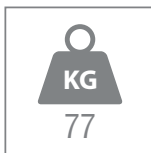
NITRO BASIC 3000**GENERATORE DI AZOTO PER GONFIAGGIO PNEUMATICI**

di auto e veicoli commerciali (sistema psa)

NITROGEN GENERATOR

for car and commercial vehicle tyre inflating (psa system)

GENERADOR DE NITRÓGENO PARA INFLADO NEUMÁTICO

de automóviles y vehículos comerciales (sistema psa)

- Pressione max. aria ingresso: 10 bar
- Pressione azoto in uscita: 6-8 bar
- Capacità: 50 lt/min
- Purezza minima: 96%
- Capacità serbatoio: 50lt
- Alimentazione: 220V 50/60Hz

Accessori standard:

- 2 tubi + pistola per vuoto-gonfiaggio

- Max. inlet air pressure: 10 bar
- Outlet nitrogen pressure: 6-8 bar
- Capacity: 50 lt/min
- Min. purity: 96%
- Tank capacity: 50lt
- Power supply: 220V 50/60Hz

Standard accessories:

- 2 hoses + vacuum-inflating gun

- Presión max. de aire en entrada: 10 bar
- Presión de nitrógeno en salida: 6-8 bar
- Capacidad: 50 lt/min
- Pureza mínima: 96%
- Capacidad del tanque: 50lt
- Alimentación: 220V 50/60Hz

Accesorios estándar:

- 2 tubos y generador di vacío

Cod. 03.031.16

€ 109,00

KIT DI 2 FLANGE Ø 240 MM

Per sospensioni anteriori di fuoristrada, station wagon

KIT OF 2 FLANGES Ø 240 MM

For front-wheel suspensions of all-terrain vehicles and station wagons

KIT DE 2 BRIDAS Ø 240 MM

Para suspensiones delanteras de todo terreno y station wagon

BMW 7ER (E38)
CHRYSLER
RENAULT
GM-X & C
LANCIA (GAMMA)



Cod. 03.031.01

€ 149,00

SMONTAMOLLE PER SOSPENSIONI MACPHERSON**SPRING COMPRESSOR FOR MACPHERSON SUSPENSIONS****EXTRACTOR DE MUELLES PARA SUSPENSIONES MACPHERSON**

① ø 110 mm

② ø 150 mm

③ ø 200 mm

SMONTAMOLLE SPECIALI PROFESSIONALI PER MOLLE AD ELICA SINISTRA E DESTRA
SPECIAL PROFESSIONAL SPRING COMPRESSOR FOR LEFT AND RIGHT SPRINGS
COMPRESOR DE MUELLES PROFESIONAL ESPECIAL PARA MUELLES DE HÉLICE IZQUIERDA Y DERECHA

sinistra/left/izquierda destra/right/derecha

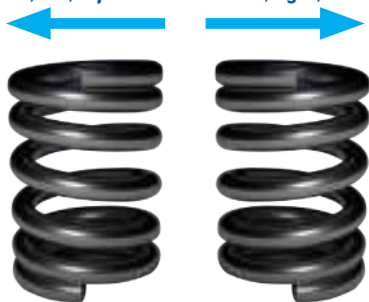

- I nostri nuovi compressori per molle elicoidali sono stati appositamente progettati per le molle elicoidali con avvolgimento sinistro che si trovano sui moderni veicoli. Il nuovo design delle flange consente alle molle ad avvolgimento sinistro di appoggiarsi in modo sicuro alla curva delle flange.
- Adatto per molle elicoidali MacPherson
- Fornito con cinque paia di flange intercambiabili di dimensioni diverse, per molle elicoidali destre/sinistre
- Protezione delle flange in plastica che protegge il rivestimento della molla da danni, che possono invalidare la garanzia del produttore del veicolo
- Flange di sicurezza accuratamente sagomati per impedire l'incurvamento della molla durante la compressione

- Our new coil spring compressors have been specially designed for the left winding coil springs found on same modern vehicles. Our new flanges design allows left winding springs to seal safely and securely to the curve of the flanges
- Suitable for MacPherson strut coil springs
- Supplied with five pairs of different sized interchangeable flanges, for right/left-handed coil springs
- Plastic flanges protection that protects the spring coating from damage, which can invalidate the vehicle manufacturer's guarantee
- Safety flanges carefully shaped to stop the spring bowing while under compression

Cod. 03.031.38

€ 298,00

SMONTAMOLLE PER MOLLE AD ELICA

sinistra e destra

PROFESSIONAL COIL SPRING COMPRESSOR SET

right hand/left hand

COMPRESOR DE MUELLES PARA MUELLES DE HÉLICE

izquierda y derecha



- Portata: 2500 kg
- 1 paio di flange per un campo d'applicazione da Ø80 a 105mm
- 1 paio di flange per un campo d'applicazione da Ø105 a 140mm
- 1 paio di flange per un campo d'applicazione da Ø145 a 190mm
- Apertura massima: 265 mm
- Guida: esagonale da 21 mm

- Capacity: 2500kg
- 1 pair of flanges for an application range Ø80-105mm
- 1 pair of flanges for an application range Ø105-140mm
- 1 pair of flanges for an application range Ø145-190mm
- Maximum opening: 265mm
- Guidance: 21mm hex

- Capacidad: 2500kg
- 1 par de bridas para un rango de aplicación de Ø80-105 mm
- 1 par de bridas para un rango de aplicación de Ø105-140 mm
- 1 par de bridas para un rango de aplicación de Ø145-190 mm
- Apertura máxima: 265mm
- Guía: hexagonal de 21 mm

Cod. 03.031.39

€ 195,00

SMONTAMOLLE PER MOLLE AD ELICA

sinistra

PROFESSIONAL COIL SPRING COMPRESSOR SET

left hand

COMPRESOR DE MUELLES PARA MUELLES DE HÉLICE

izquierda



- Portata: 2500 kg
- 1 paio di flange per un campo d'applicazione da Ø80 a 105mm
- 1 paio di flange per un campo d'applicazione da Ø105 a 140mm
- 1 paio di flange per un campo d'applicazione da Ø145 a 190mm
- Apertura massima: 265 mm
- Guida: esagonale da 21 mm

- Capacity: 2500kg
- 1 pair of flanges for an application range Ø80-105mm
- 1 pair of flanges for an application range Ø105-140mm
- 1 pair of flanges for an application range Ø145-190mm
- Maximum opening: 265mm
- Guidance: 21mm hex

- Capacidad: 2500kg
- 1 par de bridas para un rango de aplicación de Ø80-105 mm
- 1 par de bridas para un rango de aplicación de Ø105-140 mm
- 1 par de bridas para un rango de aplicación de Ø145-190 mm
- Apertura máxima: 265mm
- Guía: hexagonal de 21 mm

Tutte le immagini dei prodotti pubblicate in questo catalogo sono puramente indicative e possono essere cambiate senza preavviso.
All product images published in this catalogue have explanatory purposes and can be changed with no warning.

Cod. 03.000.38

€ 337,00

GONFIATORE ELETTRONICO PER USO INTERNO E ESTERNO ELECTRONIC TYRE INFLATOR FOR INDOOR AND OUTDOOR USE INFLADOR NEUMATICOS DE ALTO FLUJO PARA USO INTERNO Y EXTERNO



- Pressione max. in entrata **10,5 bar**
- Tubo da 8 mt + valvola di gonfiaggio
- Ideale per: centri servizi rapidi, noleggio auto, concessionari
- Max. inlet pressure **10,5 Bar**
- 8 m hose with clip-on chuck
- Ideal for: Quick Service Centers, Rental Car Facilities and Car Dealers
- Max. presión de entrada **10,5 bar**
- Manguera de 8 m con boquilla con traba
- Ideal para: Centros de servicio rápido, Alquiler de coches

Cod. 03.000.40

€ 425,00

GONFIATORE ELETTRONICO AD ALTO FLUSSO PER USO INTERNO E ESTERNO HIGH FLOW TYRE INFLATOR FOR INDOOR AND OUTDOOR USE INFLADOR NEUMATICOS DE ALTO FLUJO PARA USO INTERNO Y EXTERNO



- Pressione max. in entrata **13 Bar**
- Collettore a 4 uscite + 4 tubi da 2 mt con valvole di gonfiaggio di serie
- Può gonfiare fino a 4 pneumatici per volta
- Ideale per: gommisti, autocarri, grandi flotte

- Max. inlet pressure **13 Bar/188 Psi**
- Inflates 1 to 4 tyres simultaneously
- 4 way manifold kit with 4x2m hoses
- Ideal for Tyre Service Centers, Tyre Mounters and Fleet Operations

- Max. presión de entrada **13 bar**
- Infla 1-4 neumáticos simultáneamente
- Kit colector de 4 vías con mangueras de 4x2m
- Ideal para centros de servicio montadores neumáticos y trabajo con las flotas

Cod. 03.000.45

€ 59,00

PISTOLA DI GONFIAGGIO DIGITALE "HIGH QUALITY" HAND HELD ELECTRONIC INFLATOR "HIGH QUALITY" PISTOLA DE INFLADO DIGITAL „HIGH QUALITY“



- Corpo in alluminio, copertura in gomma
- Separazione batteria
- Display di ampia dimensione retroilluminato
- Accuratezza $\pm 0,08$ bar
- Gamma misura 12 bar
- Misura in PSI, BAR, KPA, KGF
- Certificato di taratura incluso

- Aluminum body, gum cover
- Battery separation
- Big backlight display
- Accuracy $\pm 0,08$ bar
- Measure range 12 bar
- Measure units: PSI, BAR, KPA, KGF
- Calibration certificate included

- Estructura de aluminio, cobertura de goma
- Separación batería
- Amplia pantalla retroiluminada
- Precisión $\pm 0,08$ bar
- Gama medición 12 bar
- Medición en PSI, BAR, KPA, KGF
- Certificación de calibración incluido

Tutte le immagini dei prodotti pubblicate in questo catalogo sono puramente indicative e possono essere cambiate senza preavviso.
All product images published in this catalogue have explanatory purposes and can be changed with no warning.

Prezzi promozionali / IVA e trasporto non incluso • Promotional prices • Precios promocionales

PROMO 2024

101

Cod. 03.000.54

€ 139,00



TALLONATORE PER PNEUMATICI 20L
BEAD SEATER FOR TUBELESS TYRES, 20L
CALZADOR DE TALON PARA NEUMÁTICOS, 20L

DISPONIBILE DA GIUGNO 2024 / AVAILABLE FROM JUNE 2024 / DISPONIBLE A PARTIR DE JUNIO 2024



- Capacità serbatoio: 20 lt
- Valvola di sicurezza per sovrappressione
- Pressione d'esercizio: 8 bar
- Pressione massima serbatoio: 10 bar
- Manometro con scala graduata
- Seconda maniglia vicino al pulsante (per non staccare le mani durante l'uso)
- Dimensioni imballo: 45x40x33 cm,
- Peso: 12 kg

- Tank capacity: 20 lt
- Overpressure safety valve
- Operating pressure: 8 bar
- Max. tank pressure: 10 bar
- Pressure gauge with graduated scale
- Second handle near the button (so as not to remove your hands during use)
- Packaging dimensions: 45x40x33 cm
- Weight: 12 kg



- Capacidad del tanque: 20 lt
- Válvula de seguridad de sobrepresión
- Presión de funcionamiento: 8 bares
- Presión máxima del tanque: 10 bar
- Manómetro con escala graduada
- Segunda manija cerca del botón (para no quitar las manos durante el uso)
- Dimensiones del embalaje: 45x40x33 cm
- Peso: 12 kg

Cod. 03.000.52

€ 92,00

TALLONATORE PER PNEUMATICI TUBELESS
BEAD SEATER FOR TUBELESS TYRES
CALZADOR DE TALON PARA NEUMÁTICOS SIN CAMARA

- Bombola da 19 lt
- Valvola di sicurezza
- Specifico per uso in tubeless fino a 22.5"
- Manometro Ø 60mm
- Dimensioni imballo: 46x40x31 cm
- Peso: 14 kg

- 19 lt tank
- Safety release valve
- Designed for use on tires up to 22.5 "
- Ø 60mm pressure gauge
- Packaging dimensions: 46x40x31 cm
- Weight: 14 kg



- Cilindro de 19 lt
- Válvula de seguridad
- Especifico para uso sin cámara de hasta 22,5 "
- Manómetro Ø 60 mm
- Dimensiones del embalaje: 46x40x31 cm
- Peso: 14 kg



Cod. 05.088.94W

€ 39,⁹⁰

CARRELLO PORTA GOMME
TYRE TRANSPORT DOLLY
CARRO DE TRANSPORTE PARA NEUMÁTICOS



- Carrello porta gomme è progettato per un facile trasporto di pneumatici
- Rende facile e veloce spostare fino a 5 pneumatici attraverso le aree di servizio e le aree di stoccaggio
- Due unità possono essere collegate insieme e utilizzate come carrello spostare altre attrezzature leggere
- Include spazio porta accessori al centro del carrello

- Tire trolley is designed for easy transportation of tyres
- Can handle up to 5 tyres through service areas and storage areas
- Two units can be connected together and work as a ramp or cart to move other lightweight appliances, furniture, etc
- Includes accessory storage space in the center of the trolley



- Portata max: 135 kgs
- Dimensioni: 63,5 x h 11,4 cm
- 3 ruote da 76 mm (una ruota con il freno)
- Dimensioni: 63,5 x h 11,4 cm
- Dim. imballo: 65,4x58,42x8,25 cm; 4,96 kg

- Max load: 135 kgs
- Dimensions: 63.5 x h 11.4 cm
- 3 x 76mm wheels (one wheel with brake)
- Dimensions: 63.5 x h 11.4 cm
- Packing size: 65.4x58.42x8.25cm; 4.96kg



Cod. 03.000.47

€ 9,⁹⁰

MISURATORE DIGITALE DI PROFONDITÀ BATTISTRADA
DIGITAL TREAD DEPTH GAUGE

Campo di misura/range: 0-1 "/0-25.4mm/0-11/16"



Tutte le immagini dei prodotti pubblicate in questo catalogo sono puramente indicative e possono essere cambiate senza preavviso.
All product images published in this catalogue have explanatory purposes and can be changed with no warning.

Prezzi promozionali / IVA e trasporto non incluso • Promotional prices • Precios promocionales

PROMO 2024

103

Cod. 05.088.58

€ 175,00

Ø
max 800
mm



TYRES' TRANSPORT TROLLEY
CARRO DE TRANSPORTE NEUMÁTICOS
CARRELLO TRASPORTO PNEUMATICI

- Materiale: Acciaio
- Portata: 150 kg
- Ruote: 2x Ø 260mm, 2x Ø 125mm
- Diametro massimo ruota trasportabile: 800mm
- Dimensioni imballaggio: 980x680x280 mm
- Peso: 21kg
- Material Steel
- Capacity: 150 kg
- Wheels: 2x Ø 260mm, 2x Ø 125mm
- Maximum diameter transportable wheel: 800mm
- Packing dimensions: 980x680x280 mm
- Weight: 21kg
- Material: acero
- Capacidad: 150 kg
- Ruedas: 2x Ø 260mm, 2x Ø 125mm
- Diámetro máximo rueda transportable: 800mm
- Dimensiones embalaje: 980x680x280 mm
- Weight: 21kg



Ø
max 1800
mm



Foto indicativa
Indicative picture

Cod. 05.084.11L

€ 850,00

SOLLEVATORE MECCANICO
(CON MANOVELLA) PER RUOTE
DI VEICOLI COMMERCIALI,
INDUSTRIALI, MACCHINE AGRICOLE

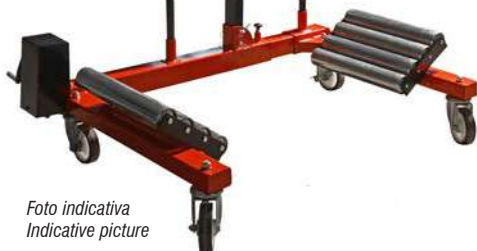
- Diametro max pneumatico: 1800mm
- Altezza di sollevamento: 0-770mm
- Capacità: 1200kgs
- Dimensioni macchina montata: 1270x990x1340mm
- Peso netto/lordo: 106/121kgs
- Dimensioni imballo: 1398x448x368mm
- Smontabile

MECHANIC LIFT FOR WHEELS
OF COMMERCIAL, INDUSTRIAL
VEHICLES AND AGRICULTURAL
MACHINERY

- Max tyre diameter: 1800mm
- Lifting height: 0-770mm
- Capacity: 1200kgs
- Assembled machine size: 1270x990x1340mm
- Net/gross weight: 106/121kgs
- Package dimensions: 1398x448x368mm
- Dismountable

GATO MECÁNICO PARA
RUEDAS DE VEHÍCULOS
COMERCIALES, INDUSTRIALES
Y MÁQUINAS AGRÍCOLAS

- Max diámetro neumático: 1800mm
- Altura de elevación: 0-770mm
- Capacidad: 1200kgs
- Tamaño máquina montada: 1270x990x1340mm
- Peso neto/bruto: 106/121kgs
- Dimensiones del embalaje: 1398x448x368mm
- Desmont

Cod. 05.088.130

€ 176,00



CARRELLO TRASPORTO GOMME TIPO PESANTE
TRANSPORT TROLLEY FOR HEAVY TYPE TIRES
CARRITO TRANSPORTE DE NEUMÁTICOS PESADOS

- Facilità d'uso per installare e togliere pneumatici per van e camion
- Rulli rotanti tipo industriale su cuscinetti
- 3 possibilità di regolazione di ampiezza per tipo di pneumatico
- Per pneumatici da 6.5"-22.5"
- Capacità di trasporto: 250 kg
- Dimensioni imballo: 73x33x15 cm, peso: 15 kg

- Easy installation and dismantling of truck wheel assemblies
- Compact design makes one person operation possible
- Three positions for rollers depending on wheel size
- Avoid damage to wheel bolts and expensive modern rims
- For all wheels from 6.5"-22.5"
- Capacity: 250 kg
- Packing dimensions: 73x33x15 cm, weight: 15 kg

- Facilidad de uso para instalar y quitar neumáticos de furgonetas y camiones
- Rodillos giratorios de tipo industrial sobre rodamientos
- 3 posibilidades de ajuste de ancho para cada tipo de neumático
- Para neumáticos de 6.5 "-22.5"
- Capacidad de transporte: 250 kg
- Dimensiones del embalaje: 73x33x15 cm, peso: 15 kg

Tutte le immagini dei prodotti pubblicate in questo catalogo sono puramente indicative e possono essere cambiate senza preavviso.
All product images published in this catalogue have explanatory purposes and can be changed with no warning.

GABBIE DI SICUREZZA PER GONFIAGGIO PNEUMATICI
SAFETY CAGES FOR TIRE INFLATION
JAULAS DE SEGURIDAD PARA INFLAR NEUMÁTICOS



Cod. 03.000.50

€ 2.590,00

BASIC

- *Per pneumatici fino a 385/60 22.5"*
- Pressione max: 10 bar
- Tubo interno con valvola di gonfiaggio inclusi
- Dim. esterni: 133x75x133 cm
- Dim. interni: 119x53x119,5 cm
- Peso: 160 kg
- Imballo in legno

- *For tires up to 385X60 22.5"*
- Max operating pressure: 10 bar
- Internal hose with inflation valve included
- External dim.: 133x75x133 cm
- Internal dim.: 119x53x119,5 cm
- Weight: 160 kg
- Delivered in wooden box

Cod. 03.000.51

€ 2.990,00

HD

PER GOMMISTI SPECIALIZZATI
FOR FOR PROFESSIONAL TIRE SPECIALISTS

- *per tutti i tipi di pneumatico inclusi quelli delle pale meccaniche gommate*
- Pressione max: 10 bar
- Tubo interno con valvola di gonfiaggio inclusi
- Dim. esterni: 155x85x150 cm
- Dim. interni: 138x64x139 cm
- Peso: 210 kg
- Imballo in legno

- *for all tyres including wheel loaders*
- Max operating pressure: 10 bar
- Internal hose with inflation valve included
- External dim.: 155x85x150 cm
- Internal dim.: 138x64x139 cm
- Weight: 210 kg
- Delivered in wooden box

• **TELAIO IN ROBUSTO TUBOLARE DI ACCIAIO Ø45MM**

- Sono dotate di una rete a maglie strette in grado di fermare frammenti di gomma o di cerchioni in caso di incidenti

- Costruita in accordo con direttiva EU 2006/42/CE – si rilascia una dichiarazione di conformità per ciascun modello.

- Le gabbie di gonfiaggio per veicoli industriali sono previste dalla **normativa C.U.N.A. NC 195-09 e UNI 10558:2005**

- Il mancato utilizzo di questi dispositivi di sicurezza, in caso di infortunio grave o morte dell'operatore, comporta la responsabilità del datore di lavoro

- Il **modello BASIC** è destinato soprattutto a imprese di autotrasporto, che svolgono al loro interno la manutenzione dei pneumatici delle trattrici e dei rimorchi

- Il **modello HD** è destinato per gommisti professionali in conto terzi. Entrambe le gabbie possono essere equipaggiate con i gonfiatori elettronici (mono tubo) cod. 03.000.38 (per modello BASIC) o con pistole di gonfiaggio manuali con tubo di lunghezza adeguata (almeno 2 mt)

• **STRONG Ø45MM TUBULAR STEEL FRAME**

- Equipped with a tightly meshed net capable of stopping rubber fragments or rims in case of accidents

- Built in accordance with EU directive EU 2006/42/CE - a declaration of conformity is issued for each model

- The inflation cages for industrial vehicles are laid down in the **C.U.N.A. NC 195-09 and UNI 10558: 2005 regulations**

- Failure to use these safety devices, in the event of serious injury or death of the operator, entails the responsibility of the employer

- The **BASIC model** is mainly intended for road haulage companies, which carry out the maintenance of tractor and trailers' tires internally

- The **HD model** is intended for professional tire specialists on behalf of third parties. Both cages can be equipped with electronic inflators (single tube) cod. 03.000.38 (for BASIC model) or with manual inflation guns with a hose of suitable length (at least 2 meters)



AVVITATORI CON SISTEMA DI RAFFREDDAMENTO AD ARIA

Il sistema di raffreddamento ad aria mantiene gli avvitatori sempre a bassa temperatura

IMPACT WRENCH WITH AIR COOLING SYSTEM

Air cooling system keeps tools in low temperature all the time



Cod. 05.091.12CX

€ 295,00

BUDGET
LINE

3/4" AVVITATORE AD IMPULSI

in materiale composito a DOPPIO battente

3/4" IMPACT WRENCH

in composite material with DOUBLE hummer

3/4" LLAVE DE IMPACTO

en material compuesto con percutor DOBLE

3/4"

COPPIA DI SERRAGGIO MAX
MAX. WORKING TORQUE
TORSIÓN DE APRIETE MAX
1.280 Nm



DOPPIO BATTENTE

TWIN HAMMER

209 MM

3,8 KG

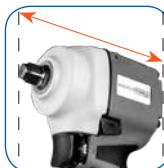
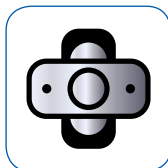

6000 RPM

2.092 NM



6,2 Bar
max

Cod. 05.091.12.R1

€ 48,00

Kit riparazione
Repair kit
Kit de reparación



Cod. 05.091.13

€ 110,00

BUDGET
LINE

1/2" AVVITATORE AD IMPULSI

con sistema di raffreddamento ad aria

1/2" IMPACT WRENCH

with air cooling system

1/2" LLAVE DE IMPACTO

con sistema de refrigeración por aire

1/2"

COPPIA DI SERRAGGIO MAX
MAX. WORKING TORQUE
TORSIÓN DE APRIETE MAX
2.230 Nm



DOPPIO BATTENTE

TWIN HAMMER

185 MM

2,2 KG

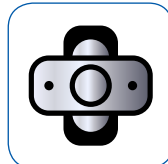

7.500 RPM

2.230 NM



6,2 Bar
max

Air Flow
184 lt/1

Cod. 05.091.14 € **82,00**

**BUDGET
LINE**



1/2" AVVITATORE AD IMPULSI
con sistema di raffreddamento ad aria

1/2" IMPACT WRENCH
with air cooling system

1/2" LLAVE DE IMPACTO
con sistema de refrigeración por aire

1/2"
COPPIA DI SERRAGGIO MAX
MAX. WORKING TORQUE
TORSIÓN DE APRIETE MAX
1.200 Nm

DOPPIO BATTENTE

TWIN HAMMER

120 MM

1,2 KG

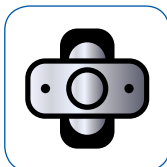

9.000 RPM

1.200 NM



**6,2 Bar
max**

**Air Flow
170 lt/1**

Cod. 05.091.11 € **135,00**

**BUDGET
LINE**



1/2" AVVITATORE ANGOLARE AD IMPULSI

1/2" RIGHT ANGLE IMPACT WRENCH

1/2" LLAVE DE IMPACTO ANGULAR

1/2"
COPPIA DI SERRAGGIO MAX
MAX. WORKING TORQUE
TORSIÓN DE APRIETE MAX
500 Nm

MONOBATTENTE

JUMBO HAMMER

7500 RPM

1,42 KG

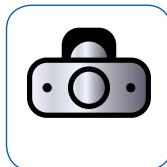

88 MM

248 MM

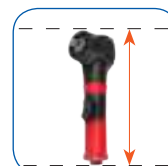
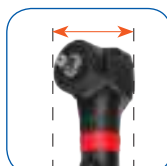

**6,2 Bar
max**



Tutte le immagini dei prodotti pubblicate in questo catalogo sono puramente indicative e possono essere cambiate senza preavviso.
All product images published in this catalogue have explanatory purposes and can be changed with no warning.

Cod. 05.091.05DP

€ 171,00

1/2" AVVITATORE AD IMPULSI

in materiale composito a DOPPIO battente

1/2" IMPACT WRENCH

in composite material with DOUBLE hammer

1/2" LLAVE DE IMPACTO

en material compuesto con percutor DOBLE

1/2"

COPPIA DI SERRAGGIO MAX
MAX. WORKING TORQUE
TORSIÓN DE APRIETE MAX

1.283 Nm



DOPPIO BATTENTE

TWIN HAMMER

179 MM

1,6 KG

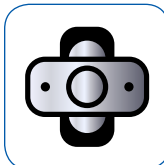

8500 RPM

1.283 NM



6,2 Bar
max

Cod. 05.091.05DPR1

€ 30,00

Kit riparazione / Repair kit / Kit de reparación



Cod. 05.091.04DP

€ 148,00

1/2" AVVITATORE NANO AD IMPULSI

in materiale composito a DOPPIO battente

1/2" MINI IMPACT WRENCH

in composite material with DOUBLE hammer

1/2" MINI LLAVE DE IMPACTO

en material compuesto con percutor DOBLE

1/2"

COPPIA DI SERRAGGIO MAX
MAX. WORKING TORQUE
TORSIÓN DE APRIETE MAX

610 Nm



DOPPIO BATTENTE

TWIN HAMMER

125 MM

1,25 KG

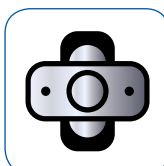

10000 RPM

610 NM



6,2 Bar
max

Cod. 05.091.04DPR1

€ 30,00

Kit riparazione
Repair kit
Kit de reparación



ACCESSORI PER AVVITATORI A IMPATTO
ACCESSORIES FOR IMPACT WRENCHES
ACCESORIOS PARA LLAVES DE IMPACTO

Cod. 05.090.58 € 30,00



5pcs 1/2" Drive Impact Socket Set
The 6pt sockets are externally sleeved to prevent damage to alloy wheels.
Color coding for ease of size selection.
Size: 15, 17, 19, 21, 22mm

Bussola smontaggio bulloni 1/2", 5pz
Le bussole da 6pt sono dotate di manica per prevenire danni ai cerchi in lega.
I colori permettono un facile riconoscimento delle misure.
Misure: 15, 17, 19, 21, 22mm

Juego de 5pcs de dados de impacto 1/2"
Los dados de 6pt tienen una manga externa para evitar daños en las llantas de aleación.
Codificación de colores para facilitar la selección de las dimensiones:
15, 17, 19, 21, 22mm

Cod. 05.090.61 € 38,00

FINE SERIE
SELL OUT

CR-MO



Set bussole 1/2" 10 pz
EXTRA CORTE per chiave a impulso 10-24mm
Prolunga 150mm
Giunto girevole

1/2" 10pcs kit of impact sockets
EXTRA SHORT for impact wrench 10-24mm
Extension bar 150mm
Universal joint

Juego de 10pcs de dados 1/2" de impacto para llave de impacto 10-24mm
Barra de extensión de 150mm
Junta universal

Cod. 05.090.54 € 30,90

CR-MO



12.5 1/2"

Kit 9pz 1/2" inserti bussole
9pcs 1/2" Drive Impact Bits Socket
Juego de 9pcs 1/2" insertos dados
Taglie/ Sizes/ Tallas:
4, 5, 6, 8, 9, 10, 12, 14, 16 mm

Cod. 05.090.56 € 30,90

CR-MO



12.5 1/2"

Kit 9pz 1/2" inserti bussole
9pcs 1/2" Impact Sockets Set
Juego de 9pcs 1/2" insertos dados
Taglie/ Sizes/ Tallas:
T20, T25, T30, T40, T45, T50, T55, T60, T70

Cod. 05.090.88 € 8,00



Bussola per smontaggio bullone antifurto, con profilo Toyota / Hyundai / Kia
Socket for removing anti-theft bolt with Toyota / Hyundai / Kia profile
Junta de extracción perno antirrobo con contorno Toyota / Hyundai / Kia

Cod. 05.090.66 € 8,00

MERCEDES



Ø17 L = 80mm

Bussola per smontaggio bullone antifurto, con profilo Mercedes
Socket for removing anti-theft bolt with Mercedes profile
Junta de extracción perno antirrobo con contorno Mercedes
Idonea per i modelli:
Suitable for the models:
Compatible con los modelos:

C&GLK	W204
E	W211, W212, W207
SLK	W172
CL	W216
S	W221, W222

Cod. 05.090.24 € 15,00



Supporto magnetico per avvitatore ad aria e bussole
2-magnets holder for air impact wrench and sockets
Soporte de 2 magnetos para llaves de impacto y brujulas

Cod. 05.090.55 € 30,90

CR-MO



12.5 1/2"

Kit 9pz 1/2" inserti bussole
9pcs 1/2" Drive Impact Bits Socket
Juego de 9pcs 1/2" insertos dados
Taglie/ Sizes/ Tallas:
5, 6, 7, 8, 9, 10, 12, 13, 14 mm

Cod. 05.090.57 € 30,90

CR-MO



12.5 1/2"

Kit 8pz 1/2" inserti bussole esagonali
8pcs 1/2" Drive Impact Hex Bits Socket
Juego de 8 pcs 1/2" insertos dados hexagonales
Taglie/ Sizes/ Tallas:
5, 6, 8, 10, 12, 14, 17, 19mm

Tutte le immagini dei prodotti pubblicate in questo catalogo sono puramente indicative e possono essere cambiate senza preavviso.
All product images published in this catalogue have explanatory purposes and can be changed with no warning.

Prezzi promozionali / IVA e trasporto non incluso • Promotional prices • Precios promocionales

PROMO 2024

109

PROMO 2024

SET BUSSOLE RIMOZIONE DADI ANTIFURTO
SET OF SOCKETS FOR REMOVING ANTI-THEFT BOLTS
JUNTAS DE EXTRACCIÓN PERNOS ANTIRROBO



ATTENZIONE! NON UTILIZZARE AVVITATORI A PERCUSSIONE con questi kit bussole rimozione dadi antifurto!



WARNING! DO NOT USE IMPACT WRENCH for these sets of sockets for removing anti-theft bolts!



ATENCIÓN! NO SE PUEDEN UTILIZAR LLAVES DE IMPACTO a percusión con estos juntas de extracción pernos antirrobo!

Cod. 05.090.68

€ 69,00



PORSCHE

Set 20 chiavi a bussola per rimozione dadi antifurto PORSCHE
20 pcs anti theft wheel nut remover for PORSCHE
20 llaves de vaso para tornillos antirrobo de ruedas PORSCHE

OEM T10190

Cod. 05.090.77

€ 65,00



BMW

Set 21 chiavi a bussola per rimozione dadi antifurto BMW
21 pcs anti theft wheel nut remover for BMW
21 llaves de vaso para tornillos antirrobo de ruedas BMW

OEM 36-1-335

Cod. 05.090.79

€ 89,00



VW

Set 20 chiavi a bussola per rimozione dadi antifurto VW
20 pcs anti theft wheel nut remover for VW
20 llaves de vaso para tornillos antirrobo de ruedas VW

OEM T10133

Cod. 05.090.67

€ 98,00



BMW

Set 20 chiavi a bussola per rimozione dadi antifurto BMW
20 pcs anti theft wheel nut remover for BMW
20 llaves de vaso para tornillos antirrobo de ruedas BMW

OEM 36-2-010

Cod. 05.090.78

€ 69,00



VW

Set 23 chiavi a bussola per rimozione dadi antifurto VW
23 pcs anti theft wheel nut remover for VW
23 llaves de vaso para tornillos antirrobo de ruedas VW

OEM T-101-01 / T40004

Cod. 05.090.80

€ 89,00



AUDI

Set 20 chiavi a bussola per rimozione dadi antifurto AUDI
20 pcs anti theft wheel nut remover for AUDI
20 llaves de vaso para tornillos antirrobo de ruedas AUDI

OEM T40073

Cod. 05.090.81

€ 126,00



MERCEDES

Set 35 chiavi a bussola per rimozione dadi antifurto MERCEDES
35 pcs anti theft wheel nut remover for MERCEDES
35 llaves de vaso para tornillos antirrobo de ruedas MERCEDES

OEM 301-332

Cod. 05.090.102

€ 59,00

NEW!
2024

UNIVERSAL RIM LOCK DISMANTLING TOOL SET

SET DI STRUMENTI UNIVERSALI PER LO
SMONTAGGIO DELLA SERRATURA DEL CERCHIO

- Per lo smontaggio di serrature da applicare con filettatura destra con profilo della presa della serratura da applicare difettoso e chiavi di azionamento difettose o smarrite
- Consente l'allentamento e lo smontaggio di oltre 24 diversi tipi di bloccaruota e dei loro sottogruppi con molti profili di bloccaggio della ruota
- Adatto per BMW, Ford, Opel/Vauxhall, PSA, VAG, Volvo

- For dismantling right-hand thread rim locks with defective rim lock socket profile and defective or lost drive keys
- Enables the loosening and dismantling of over 24 different types of wheel locks and their subgroups with many wheel lock profiles
- Suitable for BMW, Ford, Opel/Vauxhall, PSA, VAG, Volvo.

Cod. 05.098.01

€ 34,00

SERIE BUSSOLE SMONTAGGIO TAPPI OLIO MOTORE
e pulegge distribuzione
1/2" 18 PCS OIL-CHANGE AND DISTRIBUTION
pulley socket set

- Cricco 3/8" e bussole quadre da:
3/8" ratchet and square sockets:
5/16, 3/8, 7, 8, 10, 11, 12, 13, 14 mm
- Chiavi esagonali / Square sockets:
8, 9, 10, 11, 12, 14 mm
- Riangolari / Triangular: 10mm
- Chiavi esagonali / Square sockets:
8, 9, 10, 11, 12, 14 mm

Cod. 02.022.91

€ 12,00

PINZA DISTACCO RACCORDI RAPIDI
per tubi olio-benzinaPLIERS FOR DETACHMENT OF QUICK FITTINGS
for oil and petrol hosesPINZA PARA SEPARACIÓN DE CONEXIONES RÁPIDAS
para mangueras de aceite y gasolina

Cod. 05.062.00

€ 59,50

KIT DI 7 PINZE SMONTAGGIO FASCETTE PER TUBI
KIT OF 7 HOSE CLAMP PLIERS

Cod. 05.062.00.R1

€ 21,00



Cod. 05.062.02

€ 13,20

PINZA PER RIMOZIONE SUPPORTI IN GOMMA PER TUBAZIONI
DI SCARICO, utilizzabile per una vasta gamma di auto e veicoli
commercialiPLIERS FOR REMOVING RUBBER SUPPORTS OF EXHAUST GAS
SYSTEMS, suitable for a wide range of cars and commercial
vehicles

Cod. 03.036.04

€ 13,00



- Tanica scarica olio esausto (15lt)
- Temperatura di lavoro -30°/+80°C
- Comode maniglie anteriore e posteriore
- Sufficiente per tutte le applicazioni
- Tank to diascharge exhaust oil (15lt)
- Working temperature -30°/+80°C
- Comfortable front and rear handles
- Capacity enough for all the applications

Tutte le immagini dei prodotti pubblicate in questo catalogo sono puramente indicative e possono essere cambiate senza preavviso.
All product images published in this catalogue have explanatory purposes and can be changed with no warning.

SPURGAFRENI ELETTRICI ELECTRIC BRAKE BLEEDERS

Cod. 03.036.35ECO

€ 840,00

BRAKE MATE ECO

CARATTERISTICHE TECNICHE

- 2 pompe: una per il recupero del liquido usato e una per l'inserimento del liquido nuovo
- Portata pompa: 1 lt/min
- Liquidi compatibili: Pre DOT - DOT2 - DOT3 - DOT4 - DOT5 - DOT5.1 - DOT6 - DOT6.1 - LHM
- Pressione di esercizio: 0 - 4 bar
- Lunghezza tubo mandata: 7.5 m
- Lunghezza tubo aspirazione: 7.5 m
- La carrozzeria è dotata di apposito vano per riporre il corredo (A)
- 5 adattatori di varie dimensioni (B)
- Spazio per la cassetta dei nuovi tappi a richiesta cod. 03.036.28 (C)
- Spazio per taniche commerciali fino a 25 lt (D)
- Tanica da 5 lt per fluido nuovo (E)
- Tanica da 5 lt per fluido esausto (F)
- Coppia tanichette raccolta liquido usato da pinza freni (G)
- Lunghezza cavo alimentazione: 3 m
- Alimentazione: 230V 50-60 Hz
- Dimensioni: 67x54x90H cm
- Peso: 35 Kg

TECHNICAL FEATURES

- 2 pumps: one for the waste liquid recovery and one for the insertion of the new liquid
- Pump capacity: 1 lt/min
- Compatible liquids: Pre DOT - DOT2 - DOT3 - DOT4 - DOT5 - DOT5.1 - DOT6 - DOT6.1 - LHM
- Operating pressure: 0 - 4 bar
- Delivery hose length: 7.5 m
- Suction hose length: 7.5 m
- The cabinet is equipped with a special compartment for storing the accessories (A)
- 5 adapters of various sizes (B)
- Space for the optional box with new caps, cod. 03.036.28 (C)
- Space for commercial tanks up to 25 lt (D)
- 5 lt tank for the new fluid (E)
- 5 lt tank for the waste liquid (F)
- Two bottles for the used liquid collection (G)
- Power supply cable length: 3 m
- Power supply: 230V 50-60 Hz
- Dimensions: 67x54x90 cm
- Weight: 35 Kg

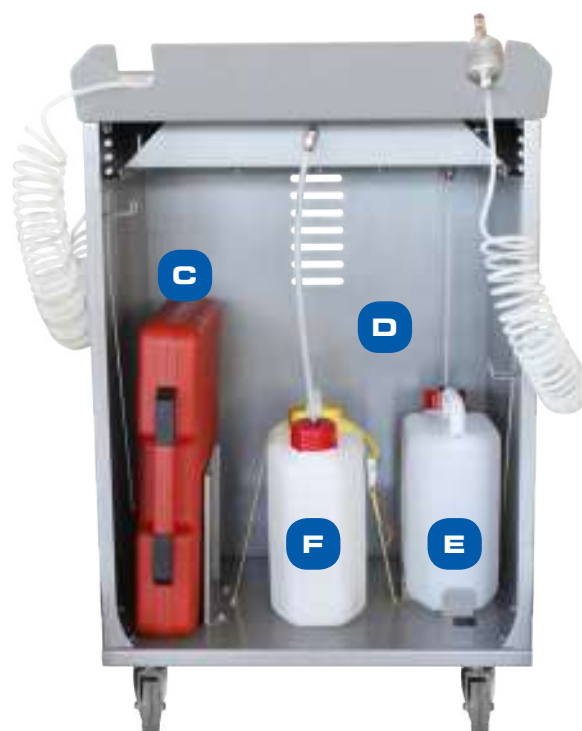
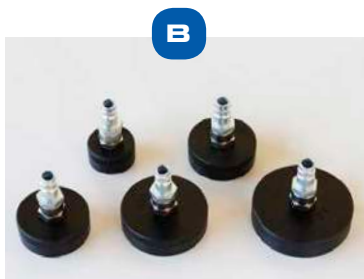

Tutte le immagini dei prodotti pubblicate in questo catalogo sono puramente indicative e possono essere cambiate senza preavviso.
All product images published in this catalogue have explanatory purposes and can be changed with no warning.

Cod. 03.036.41

€ 330,⁰⁰

BRAKE MATE BASIC PAC

NEW!
2024

CARATTERISTICHE TECNICHE

- Tensione di alimentazione:
 - DC 12/24V
 - AC 90-240V
 - Batteria a litio 21V
- Potenza massima: 48 W
- Portata massima: 2,2 Lt/minuto
- Pressione di esercizio: 0,6-3,0 bar (Non è consentito superare 3,0 bar per evitare di danneggiare la tubazione dei freni del veicolo o il sistema di tubazioni dell'attrezzatura.)
- Sistema di protezione del livello olio
- Lunghezza del tubo di riempimento: 3,5 m
- Rumore: <50 dB
- Dimensioni: 240 x 200 x 280 mm
- Accessori standard:
 - Convertitore AC-DC
 - Cavo con pinze per alimentazione da batteria
 - Batteria
 - 16 adattatori inclusi
 - 4 taniche per il recupero del fluido esausto

TECHNICAL FEATURES

- Voltage and power supply:
 - DC 12/24V
 - AC 90-240V
 - 21V lithium battery
- Maximum power: 48W
- Maximum flow rate: 2.2 Lt/minute
- Working pressure: 0.6-3.0 bar (It is not allowed to exceed 3.0 bar to avoid damaging of the vehicle brake line or equipment system)
- Oil level protection system
- Filling hose length: 3.5m
- Noise: <50dB
- Dimensions: 240 x 200 x 280 mm
- Standard accessories:
 - AC-DC converter
 - Cable with pliers for battery supply
 - Battery
 - 16 adapters
 - 4 waste fluid recovery tank

ACCESSORI STANDARD
STANDARD ACCESSORIES

Tutte le immagini dei prodotti pubblicate in questo catalogo sono puramente indicative e possono essere cambiate senza preavviso.
All product images published in this catalogue have explanatory purposes and can be changed with no warning.

Prezzi promozionali / IVA e trasporto non incluso • Promotional prices • Precios promocionales

PROMO 2024

113

Cod. 05.036.04

€ 249,00

TESTER LIQUIDO FRENI CON RISCALDATORE
BRAKE FLUID BOILING POINT TESTER 12V DC

- Alimentazione: 12V DC da batteria
- Range di misurazione: 0-320 °C
- Display a colori TFT
- Software semplice e affidabile per differenti tipi di fluido per i freni (DOT3, DOT4, SUPER DOT4, DOT5, DOT5.1).
- Power supply: 12V DC from battery
- Measuring range: 0-320 °C
- TFT color display
- Simple and reliable software for different types of brake fluid (DOT3, DOT4, SUPER DOT4, DOT5, DOT5).



Cod. 03.036.28

€ 98,00

KIT TAPPI PER SPURGOFRENI (PER BRAKE MATE ECO 03.036.35ECO)
MASTER CYLINDER ADAPTER KIT (FOR BRAKE MATE ECO 03.036.35ECO)
JUEGO DE TAPONES PARA SANGRADORES DE FRENO (PARA BRAKE MATE ECO 03.036.35ECO)



- adatto per la maggior parte degli spurgafreni a pressione
- adattatore per tappi europei, tappi multiveicolo, tappo americano (GM), BMW/Audi, Nissan, Mazda e Honda
- adattatori universali e tappi di produttori specifici
- gli adattatori son compatibili col 90% dei serbatoi attuali
- suitable for most pressure brake bleeders
- European cap adapter, multi vehicle caps, American adapter (gm), BMW/Audi, Nissan, Mazda & Honda
- universal adapters and manufacturer specific caps
- adapters fit 90% of current reservoirs
- adecuado para la mayoría de los sangradores de freno de presión
- Adaptador para tapon europeo, tapones multi-vehículo, tapon americano (GM), BMW/Audi, Nissan, Mazda y Honda
- adaptadores universales y tapones específicos del fabricante
- los adaptadores caben el 90% de los depósitos actuales

Cod. 03.036.39

€ 39,00

- Kit for Toyota



Cod. 03.036.40

€ 39,00

- Kit for Toyota Hino



Tutte le immagini dei prodotti pubblicate in questo catalogo sono puramente indicative e possono essere cambiate senza preavviso.
All product images published in this catalogue have explanatory purposes and can be changed with no warning.



Cod. 05.019.03

€ 120,00

PROVA RADIATORI E RIEMPIMENTO RADIATORI SOTTOVUOTO (26PZ)
COOLING SYSTEM ANALYZER AND RADIATORS FILL VACUUM (26PCS)
PROBADOR DE RADIADORES Y LLENADOR DE RADIADORES BAJO VACÍO (26UDS)

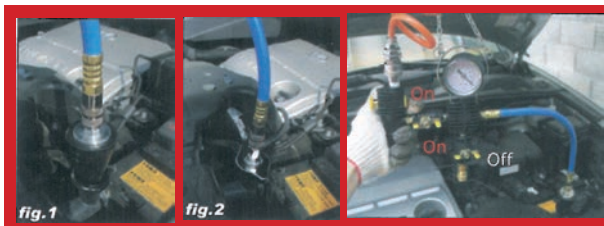

Cod. 05.090.72

€ 119,00

KIT DI 36 UTENSILI PER ESTRAZIONE E INTRODUZIONE
 silent blocks, paraoli e cuscinetti
 attrezzatura universale per settore auto e camion

KIT OF 36 TOOLS FOR THE EXTRACTION AND INSERTION
 of silent-blocks, oil blocks and bearings
 universal equipment for the vehicles' and trucks' industry

KIT DE 36 HERRAMIENTAS PARA LA EXTRACCIÓN E INSERCIÓN
 de silent-blocks, bloques aceite y cojinetes
 Equipo universal para el sector de los camiones y vehículos

Il kit contiene:

4 barre filettate
(M10, M12, M14, M16) e
20 boccole per: interni
Ø (34, 36, 38, 70, 72mm)
ed esterni
Ø (44,46, 48, 80, 82mm)

The kit includes:

4 threaded bars
(M10, M12, M14, M16),
20 bushings for:
internal Ø (34, 36, 38, 70,72mm)
and external
Ø (44, 46, 48, 80, 82mm)

El kit incluye:

4 barras roscadas
(M10, M12, M14, M16),
20 bushings para: diámetros
internos (34, 36, 38, 70, 72 mm)
y externos (44, 46, 48, 80, 82 mm)

Cod. 05.056.12

€ 41,00



CHIAVE REGOLABILE PER
SMONTAGGIO
GHIERE GALLEGGIANTI
RANGE: 89-170MM

Utilizzabile sia all'interno che
all'esterno della ghiera

ADJUSTABLE WRENCH FOR REMOVING FLOATS'
FERRULES RANGE: 89-170 MM

It can be used both inside and outside the ring

LLAVE AJUSTABLE PARA QUITAR CABEZAS
DE RANGO: 89-170MM

Se puede utilizar tanto dentro como fuera de la cabeza



Cod. 05.056.08

€ 9,90

CHIAVE SMONTAGGIO FILTRO GASOLIO (MOTORI HDI)

FUEL FILTER SOCKET (HDI ENGINES)

Specialist socket required for the removal of diesel fuel filter
fit for HDi engines

LLAVE PARA FILTRO DE COMBUSTIBLE (MOTORES HDI)

Llave para especialistas requerida para la remoción del
filtro de combustible diesel para motores HDi



• Modelli / Models / Modelos:

- C4 2.0 HDi 16v, C4 Picasso 2.0/2.2 HDi, C5, C8 2.0/2.2 HDi 16v, Jumpy 2.0/ 2.2 HDi;
- Fiat Scudo, Ulysse Mk II 2.0 JTD 16v;
- Ford Focus/ Focus C-Max Galaxy/ Kuga S-Max 2.0 TDCi;
- Peugeot 307/ 308/ 407/ 607 807/ Expert 2.0 HDi 16v;
- Volvo C30/ C70/ S40 Mk II, V50 2.0 Diesel (136 HP).



Cod. 05.058.01

€ 77,⁹⁰

NUOVO KIT REGISTRO PISTONCINI FRENI
con pistone pneumatico

NEW BRAKE CALIPER TOOL KIT
with pneumatic piston

NUEVO CALIBRADOR NEUMÁTICO DE FRENOS
con pistón neumáticos

Il pistone pneumatico mantiene la pressione sul cilindretto che può essere facilmente ruotato verso destra o verso sinistra dalla leva.

The pneumatic piston maintains the pressure on the cylinder that can be easily turned right or left by using a lever.

El pistón neumático presiona el cilindro que se puede girar a la derecha o a la izquierda utilizando la palanca.

Cod. 05.058.07

€ 29,⁵⁰



AGGIORNAMENTO AL KIT
UPGRADE FOR KIT
ACTUALIZACIÓN PARA KIT
05.058.01

APPLICAZIONI / APPLICATIONS / APLICACIONES

B1 Ford	B4 BMW	W Passat VW
B3 BMW	B5 Mini/BMW	B2 Iveco Daily

Cod. 05.058.09

€ 22,⁰⁰

SET 3PCS ARRETRATORI PISTONCINI
KIT OF 3 PCS OF SMALL PISTONS' PULLERS
KIT DE 3 PIEZAS DE EXTRACTORES PARA PISTONES PEQUEÑOS



Aggiornamento al kit - Upgrade for kit - Actualización para kit 05.058.01

Cod. 05.058.08

€ 10,⁵⁰



KIT RIMOZIONE
PINZE FRENO, 3PZ
BRAKE CALIPERS'
DISMANTLING KIT, 3PCS
KIT DE DESMONTAJE
PINZAS DE FRENO, 3 UN.

Il kit include:
Chiave pentagonale da 14mm per Opel Zafira, Astra, Smart
Chiave pentagonale da 19 mm per pinze Bendix (Citroen, Peugeot, Renault)
Chiave pentagonale da 10mm per pinze Girling

The kit includes:
14mm pentagonal socket wrench for Opel Zafira, Astra, Smart
19mm pentagonal socket wrench for Bendix calipers (Citroen, Peugeot, Renault)
10 mm male pentagonal socket wrench for Girling calipers

El kit incluye:
Llave pentagonal de 14mm para Opel Zafira, Astra, Smart
Llave pentagonal de 19mm para pinzas Bendix (Citroen, Peugeot, Renault)
Llave pentagonal de 10mm para pinzas Girling

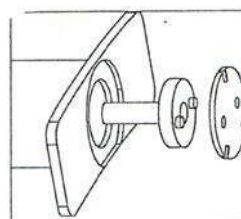

Il kit include/the kit includes/el kit incluye:

- A) VW, Audi A4-5-6-8, VW Passat, Tiguan 2007
- B) BMW, Mini, Smart, VW
- C) Nissan - Opel - Toyota

Cod. 05.056.20

€ 3,⁹⁰

CHIAVE UNIVERSALE PER FILTRI OLIO/GASOLIO
regolabile 50-100mm diametro

OIL FILTER STRAP WRENCH
adjustable 50-100mm diameter



Cod. 05.056.07

€ 64,00

SET DI CHIAVI SMONTAGGIO FILTRI OLIO PER AUTO E FURGONI
OIL FILTERS CUPS KITS FOR CARS-VANS
SET DE LLAVES PARA FILTROS ACEITE COCHES-CAMIONETAS



Cod. 05.056.03

€ 19,00

Mercedes, Smart, VW, Opel, BMW
(24/27/32/36/38mm)

FINE SERIES
SELL OUT

66mm/6P	Fiat Punto, 1 2) Renault (Clio 1 2 Express, Kangoo Twingo) etc	86mm/16P	Volvo (S40.S60.S70,S80) etc
65mm/14P	Champ. Hastings GnVAc. wix, Napa, Purolator, Diahatsu, Toyota, Nissan etc	86mm/18P	VW Golf (MKIIITdi,passatTdi.) Audi A6 Tdi, Renault (ClioRapid19D Laguna Safrane Espace 21D) Citroen, Peugeot, Renault, etc
65-67mm/14P	Fits same filters as made in Canada including PH4386 PH4967 PH6017 PH6018 Daihatsu etc.	90mm/15P	Fits Honda Accord Mitsubishi Mopar Isuzu
68mm/14P	Hastings, Mazda, Ford Escor, Capri, Subaru, Fran PH6607 (tram filters made in Korea), Motorcraft FLS16	92mm/10P	Fiat Cinquecento, Coupe, Croma. Fiat. Panda Regata Ritmo Fiat. Seicento Tempra. Tipo.Lancia (Beta Dedra Kappa Monte Carlo Prisma Thema Trevi) etc
73mm/14P	Toyota / Lexus, etc	93mm/15P	Casite, Champ. Champion, GM Fram. Hastings Opel, Mazda, Volvo, Mitsubishi Purolator. Wix, Nissan, VW, Porsche. Renault Ford, Honda, Audi etc
74mm/15P	MF. Audi, #056-115-561g, GM. Rover. Chrysler, etc.	93mm/36P	Fits Motorcraft only-FL1A, FLA1B. FL300. FL820. Ford, etc
74-76mm/15P	Fits Fram, Ac. Saturn. etc	93mm/45P	VW-Audi (Tdi2 4.2 6,2 8L)etc
75-77mm/15P	VW, Audi Casite, GM/AC, Hastings, Wix.NAPA, Ford, Isuzu, Mercedes, Opel,etc.	95mm/15P	Toyota #15600-41010 Alfa. GM, Ford. ALFA, Chrysler, etc
76mm/12P	Fiat (Ducato. ScurJo. Ulysee), Renault. (Megane Laguna Espace III) etc	96mm/18P	Audi (A4A6Tdi). VW(Passaf97Tdi) Renault (Laguna2.2d Safrane2.2D.) Espace2.2DR19. RAPID.MEGANE.19/21DTDi) etc
76mm/14P	Champion, Champ Lee, Purolator, Mopar. VW, Porsche, Mercedes Benz, BMW, Audi. (I. B. A3TD) Opel etc.	100mm/15P	Fits fram, Motorcraft. wix, Isuzu and Mitsubishi, etc
76mm/30P	Fits Motorcraft only-FL400A. Ford etc	106mm/15P	Fiat (Ducato 2 5D Td) etc
76mm/8P	Fiat(Marea), Lancia (Delta) etc.	108mm/15P	Volvo(C70.S70.V70.Tdi TD)(Turbo. Diesel 850 Tdi Diesel)etc
78mm/15P	Nissan #15208H8991. Ford, Toyota, Accord etc	108mm/18P	Renault (Espace, Laguna. Master, Safrane, Traffic 2.4, 2.5, 2.8D, TD) etc
80mm/15P	Hastings Fram, Purolator, Nissan, Honda. Motorcraft, Mazda, Isuzu, Subaru. Opel. Toyota, etc	A2089	
80-82mm/15P	Wix filters branded for Mazda, Subaru, Toyota, Honda, Acura Nissan, NAPA etc.	Adapter	

Cod. 05.056.09

€ 43,00

SET 6 CHIAVI PER FILTRI OLIO (COLORATE)
KIT OF 6 WRENCHES FOR OIL FILTERS (COLOURED)
JUEGO DE 6 LLAVES PARA FILTROS ACEITE (COLORADAS)



IL KIT INCLUDE: THE KIT INCLUDES: EL KIT INCLUYE:

	COLORE COLOUR COLOR	APPLICAZIONI USES USOS	Ømm/lati sides lados
A	Rosso - Red - Rojo	Mercedes Benz Jeep - Chrysler	Ø84 - 14
B	Verde-Green-Verde	BMW - Volvo	Ø86 - 16
C	Blu - Blue - Azul	Kia Hyundai	Ø89 - 15
D	Giallo - Yellow - Amarillo	Alfa Romeo - Fiat Opel - Suzuki	Ø75 - 16
E	Azzurro - Light Blue Azul claro	Hyundai	Ø77 - 15
F	Celeste - Pale blue Azul palido	Alfa Romeo, Fiat, Lancia	Ø90 - 10



Cod. 05.062.05

€ 11,90

Pinza per filtri olio Ø46mm (VW, Audi, Skoda, Seat)

Pliers for oil filters Ø46mm (VW, Audi, Skoda, Seat)

Alicates para filtros de aceite Ø46mm (VW, Audi, Skoda, Seat)

Tutte le immagini dei prodotti pubblicate in questo catalogo sono puramente indicative e possono essere cambiate senza preavviso.
 All product images published in this catalogue have explanatory purposes and can be changed with no warning.

Prezzi promozionali / IVA e trasporto non incluso • Promotional prices • Precios promocionales

PROMO 2024

117

Cod.02.022.113

€ 136,00



POMPA MANUALE PER L'INSERIMENTO DI OLIO NEI CAMBI MANUALI, AUTOMATICI E NEI DIFFERENZIALI

- Il kit include 12 adattatori per la connessione diretta
- Valvola di non ritorno per un'efficace azione di inserimento dell'olio senza perdite
- Portata: 70cc a pompata
- Capacità serbatoio: 7 lt
- Massima viscosità olio utilizzabile: SAE 140

MANUAL PUMP FOR THE INSERTION OF OIL IN MANUAL, AUTOMATIC AND DIFFERENTIAL TRANSMISSIONS

- The kit includes 12 adapters for direct connection
- Non-return valve for an effective oil insertion action without leaks
- Flow: 70cc per stroke
- Tank capacity: 7 lt
- Maximum viscosity of usable oil: SAE 140

BOMBA MANUAL PARA LA INSERCIÓN DE ACEITE EN TRANSMISIONES MANUALES, AUTOMÁTICAS Y DIFERENCIALES

- El kit incluye 12 adaptadores para conexión directa
- Válvula de retención para una acción efectiva de inserción de aceite sin fugas
- Flujo: 70cc por carrera
- Capacidad del tanque: 7 lt
- Viscosidad máxima del aceite utilizable: SAE 140



FORD 1/8 NPT	AT-101
UNIVERSAL (BMW, Honda, Nissan etc.)	AT-102
VW-AUDI	AT-103
VW-AUDI-PORSCHE	AT-104
VW-AUDI-MINI COOPER 10X1.0	AT-105
MERCEDES 722.9 12X1.5	AT-106
DSG 24X1.5	AT-107
VW-AUDI CVT 22X1.5	AT-108
VOLVO 5/16X24	AT-109
TOYOTA-LEXUS 18X1.5	AT-110
SKODA 30X1.5	AT-111
VW PASSAT/TIGUAN <2007	AT-112

Cod. 05.056.16

€ 27,93

Set 5 chiavi esagonali per smontaggio filtri olio in zone di difficile accesso - Ø3/8"

Set of 5 hexagonal wrenches for oil filters removal in difficult-to-access areas - Ø3/8"

Juego de 5 llaves hexagonales para la extracción de filtros de aceite en zonas de acceso difícil - Ø3/8"

Misure: Measures: Medidas: 24/27/32/36/38mm

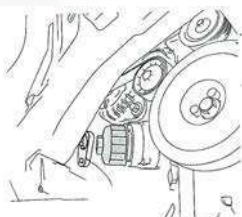



Cod. 05.067.01

€ 39,00

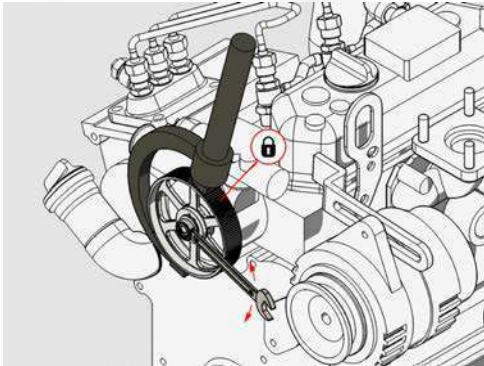

UTENSILE UNIVERSALE A MEZZALUNE BLOCCAPULEGGIE PER SMONTAGGIO PULEGGIE DI DISTRIBUZIONE

Regolabile tramite manico girevole, blocca la puleggia dell'esterno evitando eventuali danni a sensori circostanti

UNIVERSAL CRESCENT-SHAPED TOOL FOR HOLDING PULLEYS IN POSITION AND DISMANTLING DISTRIBUTION PULLEY

Adjustable via turning handle, it locks the pulley from outside avoiding damage to surrounding sensors

HERRAMIENTA UNIVERSAL EN FORMA DE MEDIALUNA PARA SUJETAR POLEAS EN POSICIÓN Y DESMONTAR LA POLEA DE DISTRIBUCIÓN

Ajustable mediante mango giratorio, bloquea la polea para evitar daños a los sensores circundantes

Cod. 05.090.75 € 9,00



Chiave smontaggio tappi olio in plastica (Gruppo VW-Audi)

Wrench for dismantling oil caps in plastic (VW-Audi Group)

Llave para desmontar las tapas de aceite en plástico (Grupo VW-Audi)



Cod.03.036.25

€ 21,00



Convogliatore olio in alluminio rivestito in gomma
Aluminum oil conveyor coated in plastic
Embudo transportador aceite recubierto en plástico

Cod. 05.062.01

€ 38,00



Pinza per serraggio e taglio fascette in acciaio inox
Pliers for tightening and cutting stainless steel clamps
Pinza para apretar y cortar abrazaderas de acero inoxidable



Cod. 05.090.76

€ 34,00

**ESTRATTORE PER GIUNTI OMOCINETICI
PULLER FOR HOMOKINETIC JOINTS
EXTRACTOR DE JUNTAS HOMOCINÉTICAS**

Permette l'estrazione dei giunti omocinetici incastrati e difficilmente rimovibili. Particolarmente indicato per vetture gruppo VAG, Ford, Fiat, CSA, BMW, Mercedes Benz, Suzuki, Volvo, Opel

LAVORA DIRETTAMENTE SUL VEICOLO

It allows the extraction of stuck and difficult to remove homokinetic joints. Especially designed for VAG, Ford, Fiat, CSA, BMW, Mercedes Benz, Suzuki, Volvo, Opel group cars

IT WORKS DIRECTLY ON THE VEHICLE

Permite la extracción de juntas homocinéticas pegadas y difíciles de quitar. Especialmente diseñado para los coches del grupo VAG, Ford, Fiat, CSA, BMW, Mercedes Benz, Suzuki, Volvo, Opel. Trabaja directamente sobre el vehículo

TRABAJA DIRECTAMENTE SOBRE EL VEHÍCULO

Tutte le immagini dei prodotti pubblicate in questo catalogo sono puramente indicative e possono essere cambiate senza preavviso.
All product images published in this catalogue have explanatory purposes and can be changed with no warning.

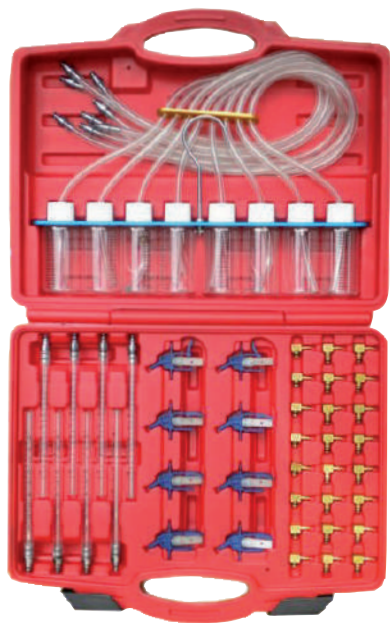

Cod. 02.016.04

€ 69,⁰⁰

NUOVO KIT MASTER PER CONTROLLO PORTATA DI RITORNO

impianto common rail

NEW KIT MASTER FOR THE BLACK FLOW CONTROL
of common rail systems

NUEVO KIT MASTER PARA EL CONTROL DE LA CAPACIDAD DE RETORNO
de las instalaciones common rail

Permette un rapido controllo delle portate di iniettori Bosch, Siemens, Delphi dei principali sistemi common rail (auto e veicoli commerciali) identificando eventuali anomalie.

It enables you to perform a quick control of the back flow of the main common rail systems (cars and commercial vehicles) detecting possible anomalies.

Permite un control rápido de las capacidades de retorno de los inyectoros Bosch, Siemens, Delphi de las principales instalaciones common rail (coches y vehículos comerciales) detectando posibles anomalías.

Il kit include:

1. Rampa con 8 burette graduate, 8 tubi e raccordi dritti per collegamento alle uscite degli iniettori
2. 8 raccordi per iniettori Delphi
3. 24 raccordi a 90° per iniettori Bosch, Siemens, Delphi
4. 8 burette da 10cc per collegamento diretto a iniettori common rail Mercedes.

The kit includes:

1. Manifold with 8 graduated burettes, 8 straight hoses and couplings for the connection to the injector outlet.
2. 8 couplings for Delphi injectors
3. 24 90° couplings for injectors iniettori Bosch, Siemens, Delphi
4. 8 10 cc burettes for direct connection to Mercedes common rail injectors

El kit incluye:

1. Rampa con 8 buretas graduadas, 8 tubos y empalmes rectos para la conexión a las salidas de los inyectoros
2. 8 empalmes para inyectoros Delphi
3. 24 empalmes de 90° para inyectoros Bosch, Siemens, Delphi
4. 8 buretas de 10cc para la conexión directa a inyectoros common rail Mercedes

Cod. 05.090.70

58,⁰⁰

KIT 17PCS FRESE PER SEDI GUARNIZIONI PARAFIAMMA/INIETTORI DIESEL

17PCS SET OF FIREPROOF SEALS/DIESEL INJECTORS SEAT CUTTERS

JUEGO DE 17 PCS DE CORTADORES DE ASIENTO PARA GUARNICIONES IGNIFUGAS/ INYECTORES DIESEL 1PZ

- | | |
|---------------------|---|
| 1pc 15.5mm x 15.5mm | fresa angolare/angled reamer/fresadora angular |
| 1pc 17mm x 17mm | fresa angolare/angled reamer/fresadora angular |
| 1pc 17mm x 21mm | fresa angolare /angled reamer/fresadora angular |
| 1pc 14mm x 14mm | fresa piana/flat reamer/fresadora regular |
| 1pc 15mm x 15mm | fresa piana/flat reamer/fresadora regular |
| 1pc 15mm x 19mm | fresa piana/flat reamer/fresadora regular |
| 1pc 17mm x 17mm | fresa piana/flat reamer/fresadora regular |
| 1pc 17mm x 17.5mm | fresa piana/flat reamer/fresadora regular |
| 1pc 17mm x 19mm | fresa piana/flat reamer/fresadora regular |
| 1pc 17mm x 19.5mm | fresa piana/flat reamer/fresadora regular |
| 1pc 17mm x 20mm | fresa piana/flat reamer/fresadora regular |
| 1pc 17.5mm x 20.5mm | fresa piana/flat reamer/fresadora regular |
| 1pc 19mm x 21.5mm | fresa piana/flat reamer/fresadora regular |
| 1pc | manico a "T"/T-handle/mango en T |
| 1pc | Pilo Post |
| 1pc 15.5mm x 225mm | fresa/cutter/cortador |
| 1pc 2.5mm | chiave esagonale/hex key/llave hexagonal |



FINE SERIE
SELL OUT

Cod. 02.020.05

€ 290,⁰⁰

POMPA MANUALE PER PROVA INIETTORI DIESEL

fino a 600 bar

MANUAL PUMP FOR DIESEL INJECTOR TESTER

up to 600 bars

BOMBA MANUAL PARA PROBA INYECTORES DIESEL

hasta 600 bar

Tutte le immagini dei prodotti pubblicate in questo catalogo sono puramente indicative e possono essere cambiate senza preavviso.
All product images published in this catalogue have explanatory purposes and can be changed with no warning.



Cod. 05.090.47

€ 130,00

M8-M9-M10

**KIT RIMOZIONE CANDELETTE
GLOW PLUG DRILLING SET
KIT DE EXTRACCION DE BUJIAS DE PRECALENTAMIENTO**

Semplice estrazione di candele
danneggiate o ingrippate su molti
moderni motori diesel
Non necessaria la rimozione della
testa del cilindro che potrebbe
danneggiare lo stampo
Adatto a motori diesel Mercedes
Benz CDI

Easy extraction of the damaged/
seized glow plugs on many
modern diesel engines
No cylinder head extraction
needed which may cause damages
to cylinder head castings
Suitable for Mercedes Benz CDI
diesel engines

Extracción fácil de las bujias
dañadas / gripadas en muchos
motores diesel modernos
No extracción de la culata
necesaria que puede causar daños
a la fundición de la culata
Adecuado para motores diesel
Mercedes Benz CDI

Cod. 05.090.07

€ 48,00



**SERIE DI 6 BUSSOLE SNODATE
PER CANDELETTE (LUNGHE)**

**KIT 6 JOINTED SOCKETS
FOR PLUGS (LONG)**

**KIT DE 6 CASQUILLOS
PARA BUJÍAS (LARGOS)**

8 mm L=155mm;
9 mm L=155mm;
10 mm L=155mm;
11 mm L=155mm;
12 mm L=155mm;
14 mm L=155mm;
16 mm L=155mm;



Per uno smontaggio sicuro delle candele
anche in posizioni difficili da raggiungere.
Includono anello in gomma
per mantenimento candele.

To dismount safely the plugs also those positioned in
difficult positions to be reached. It includes a rubber ring to
hold the plug.

Para desmontar en seguridad las bujias que están colocadas
en zonas difíciles de llegar. Incluye un anillo de goma
para la bujía.

Cod. 04.024.02

€ 175,00

**POMPA VUOTO E PRESSIONE "MYTIVAC"
VACUUM AND PRESSURE PUMP "MYTIVAC"
BOMBA DE VACÍO Y PRESIÓN "MYTIVAC"**

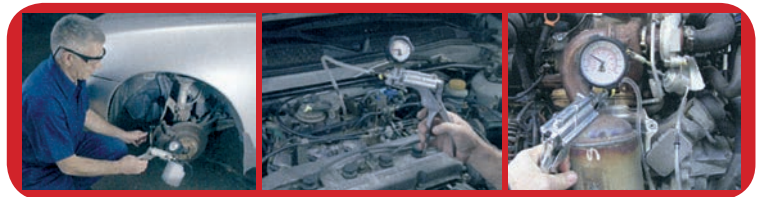

Maggiori prestazioni
(-1/+4 bar)

Manometro con protezione in
gomma rotante a 360° A

Selezione vuoto-pressione con
una sola mano

Impugnatura ergonomica C

Contenitore olio freni esau-
sto collegato direttamente alla
pompa B

Better performance
(-1/+4 bar)

Gauge with rubber protection
rotating 360° A

Selection vacuum-pressure with
only one hand

Ergonomical handle C

Exhausted brake oil recipient
connected directly to the pump B

Mayores prestaciones
(-1/+4 bar)

Manómetro con protección de
caucho giratorio de 360° A

Selección vacío-presión con
una sola mano

Empuñadura ergonómica C

Recipiente de aceite frenos
usado conectado directa-
mente a la bomba B

Cod. 04.024.01

€ 119,00

**POMPA A VUOTO E PRESSIONE (-1/3 BAR)
Completa di accessori in valigetta ABS
VACUUM-PRESSURE PUMP (-1/3 BAR)
Supplied with accessories in ABS case
BOMBA MANUAL PRESIÓN-DEPRESIÓN (-1/3 BAR)
Con accesorios en maletín de ABS incluidos**



Tutte le immagini dei prodotti pubblicate in questo catalogo sono puramente indicative e possono essere cambiate senza preavviso.
All product images published in this catalogue have explanatory purposes and can be changed with no warning.

Prezzi promozionali / IVA e trasporto non incluso • Promotional prices • Precios promocionales

PROMO 2024

121

Cod. 04.053.08

€ 165,00



**KIT TEST POMPA INIEZIONE BENZINA
FUEL INJECTION TEST SET
JUEGO DE HERRAMIENTAS PARA LA PRUEBA
DE SISTEMAS DE INYECCIÓN GASOLINA**

IL KIT INCLUDE:

- Gli adattatori più comuni per tutti i tipi di sistemi iniezione benzina
- Ampio manometro con doppia lettura Kpa, Psi da 0 a 1000Kpa (10bar)
- Un manometro di bassa pressione per misurazione accurata da 0 a 100Kpa (1bar)
- Sistema di connessione rapida

THE KIT INCLUDES:

- The most popular adaptors for all types of fuel injection systems(Petrol)
- A large gauge with dual readings Kpa, Psi from 0 to 1000Kpa (10bar)
- A low pressure gauge for accurate reading from 0 to 100Kpa (1bar)
- Quick coupling system

EL JUEGO INCLUYE:

- Los adaptadores más populares para todos los tipos de sistemas de inyección de combustible
- Un gran manómetro con lecturas dobles Kpa, Psi de 0 a 1000 kPa (10 bares)
- Un indicador de presión baja para una lectura precisa de 0 a 100 kPa (1 bar)
- Sistema de acoplamiento rápido

Cod. 04.053.09

€ 35,00

Adattatore per cod. 04.053.08 (per FIAT PANDA / PUNTO)
Adapter for cod. 04.053.08 (for FIAT PANDA / PUNTO)
Adaptador para cod. 04.053.08 (para FIAT PANDA / PUNTO)

Cod. 04.043.00

€ 69,00

Art. 060



**KIT CONTROLLO TENUTA DI GUARNIZIONI
TESTATE MOTORI BENZINA E DIESEL**

**KIT CONTROL SEALS PETROL AND DIESEL
ENGINES**

**CONPROBADOR DE FUGAS DE CULATAS
MOTORES DIESEL Y GASOLINA**

Rivela in modo sicuro incrinature e perdite sulle testate cilindri, sulle guarnizioni e sul blocco motore. Il liquido di prova si colora automaticamente nel caso di mancata ermeticità.

Detecta con precisión grietas y pérdidas en las culatas de los cilindros, en las juntas y en el motor. El liquido de prueba se colora automáticamente en caso de no estanqueidad.

It detects certainly cracks and water leaks on cylinder heads, seals and engine blocks. The test detector will colour immediately, if there are leaks.

Cod. 04.043.01

€ 27,00



**LIQUIDO DI RICAMBIO
TEST LIQUID
LIQUIDO DE RECAMBIO**

Cod. 05.098.02

€ 49,00

**KIT 114PCS TAPPI COPPA OLIO E DIFFERENZIALI
KIT OF 114PCS OIL PAN AND DIFFERENTIALS CAPS
KIT 114PCS DE TAPAS PARA CÁRTER DE ACEITE Y DIFERENCIALES**



Misure / Sizes / Tallas:

- M13 x 1
- 25-M13 x 1
- 5-M15 x 1
- 5-M17 x 1
- 5-M20 x 1
- 5-M22x1,5mm

Cod. 04.029.01

€ 38,00

**TESTER PROVA PRESSIONE OLIO MOTORE
ENGINE OIL PRESSURE TEST TESTER
TESTER PRUEBA PRESIONES ACEITE MOTOR**



- Manometro doppia scala di facile lettura fino a 10 bar
- Attacchi rapidi con valvole per operare in sicurezza e velocità
- Double-range gauge easily reading up to 10 bar
- Rapid couplings with valves to work safely and quickly
- Manómetro con doble escala, lectura fácil, hasta 10 bar
- empalmes rápidos con válvulas para trabajar en seguridad y rápidamente

Tutte le immagini dei prodotti pubblicate in questo catalogo sono puramente indicative e possono essere cambiate senza preavviso.
All product images published in this catalogue have explanatory purposes and can be changed with no warning.

Cod. 05.090.08

€ 48,⁰⁰

ESTRATTORI PER INIETTORI COMMON RAIL
COMMON RAIL INJECTORS EXTRACTOR SET
EXTRACTORES INYECTORES COMMON RAIL

THE KIT INCLUDES:

- Slide Hammer (Kg 1,75)
- adaptor M17x1.0
- adapter M27x1 for Bosch injector head
- Adapter with M12x1,75

IL KIT INCLUDE:

- Martello a battente (Kg 1,75)
- adattatore M17x1.0
- Adattatore M27x1.0 per iniettore CR Bosch
- adattatore M12x1,75

EL JUEGO INCLUYE:

- Martillo de oscilacion (Kg 1,75)
- Adaptador M17x1.0
- Adaptador M27x1 para la cabeza del inyector Bosch
- Adaptador con M12x1,75



Foto indicativa/indicative image

Cod. 04.053.05

€ 350,⁰⁰**038K9M/3000**

PROVA COMPRESIONE DIESEL
(ANCHE COMMON RAIL)

COMPRESSION TESTER FOR DIESEL
(ALSO COMMON RAIL)

TESTER PRUEBA COMPRESIÓN DIESEL
(TAMBIÉN COMMON RAIL)

Applicazioni / Applications / Aplicaciones:

Alfa Romeo, BMW, Chrysler, Daewoo, Fiat, Ford, Hyundai, ISU24, Landrover, LDV, Mazda, Mercedes, Mitsubishi, Nissan, Opel, PSA, Renault, SAAB, Suzuki, Toyota, VAG, Vauxhall, Volvo
Injectors: M20, M22, M24 e Ford Stanadyne TDI Inject

Cod. 04.053.01

€ 72,⁰⁰

TESTER PROVA COMPRESIONE MOTORI DIESEL
(auto e commerciali) con manometro 0-70 (psi)

COMPRESSION TESTER DIESEL ENGINES (cars and deliveries vans) with gauge 0-70 (psi)

TESTER PRUEBA COMPRESIÓN MOTORES DIESEL
(coches y vehículos comerciales) con manómetro 0-70 (psi)

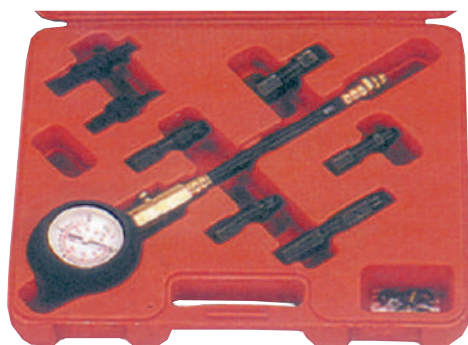

Cod. 04.053.00

€ 49,⁸⁰

Tester prova compressione motori benzina con manometro 0-20bar (psi)

Il kit include:

attacco M10x1,0 (moto)
attacco M12x1,25 (moto)
attacco M14x1,25 (2 pezzi)
attacco M18x1,5
maschio per filetti M10/M12
maschio per filetti M14/M18

Compression tester for petrol engines with manometer 0-20bar

The kit includes:

M10x1,0 coupling (motorcycles), M12x1,25 coupling (motorcycles)
M14x1,25 coupling (2 pieces)
M18x1,5 coupling
male for threads M10/M12
male for threads M14/M18

Tester prueba compresión motores de gasolina con manómetro 0-20bar (psi)

El kit incluye:

empalme M10x1,0 (moto)
empalme M12x1,25 (moto)
empalme M14x1,25 (2 unidades)
empalme M18x1,5
macho para filetes M10/M12
macho para filetes M14/M18

Cod. 04.053.07

€ 39,00

COPPIA BARRE DI ESTENSIONE PER PROVA COMPRESIONE 12/14MM
COMPRESSION TEST ADAPTORS (2PCS) 12/14MM
ADAPTADORES DE PRUEBA DE COMPRESION (2PCS) 12/14MM



Questo adattatore extra lungo per prova compressione è progettato per adattarsi a candele di 12/14mm
Questo utensile è essenziale su BMW E90 335i con motori N54 >2006, BMW MINI, MERCEDES M156, FORD DURATECH 16V
Utilizzabile anche su motori Peugeot 207/307 e Renault 1.2 16 valvole
Design speciale per estendere la filettatura delle candele in sede profonda per facilitare i test

This extra-long compression test adaptor is designed to fit 12 and 14mm spark plugs
This tool is now essential on BMW E90 335i with N54 engine 2006, BMW MINI, MERCEDES M156, FORD DURATECH 16V
Also used on Peugeot 207/307 and Renault 1.2 16 valve engines
Special design to extend the spark plug thread in the deep hole for easier testing

Este adaptador de prueba de compresión extra largo está diseñado para adaptarse a bujías de 12 y hasta 14 mm. Este instrumento es ahora esencial sobre BMW E90 335i con motor N54 2006, BMW MINI, MERCEDES M156, FORD DURATECH 16V. También se utiliza en Peugeot 207/307 y Renault 1.2 motores de 16 válvulas. Diseño especial para extender el hilo de la bujía en el agujero profundo para pruebas más fáciles.

Cod. 05.090.83

€ 79,00

INSERITORE A PERCUSSIONE PER CUSCINETTI/PARAOLI
da Ø 18÷90mm, regolabile
Peso: 15,3kg

PERCUSSION INSERTER FOR BEARINGS/OIL SEALS
from Ø 18÷90mm, adjustable
Weight: 15,3kg

DISPOSITIVO COLOCADOR DE PERCUSIÓN PARA COJINETES/RETENES PARA ACEITE
de Ø 18÷90 mm, ajustable
Peso: 15,3kg

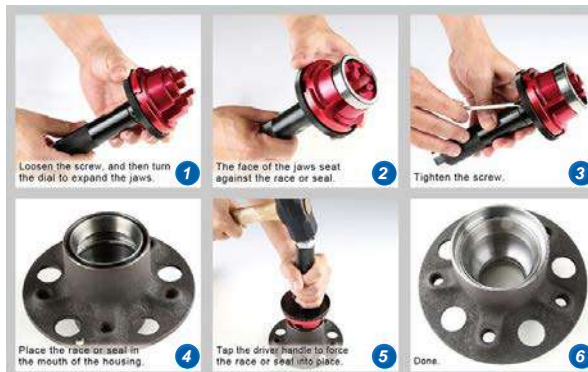

Cod. 05.062.06

€ 12,00

SET DI 3 PINZE PER MANICHETTA FLESSIBILE
3 PCS HOSE CLIP PLIERS

JUEGO DE TRES PINZAS PARA MANGUERAS FLEXIBLES

1/2" - 5/8" - 2/4"



Cod. 05.078.07

€ 79,00

LEVA DI TRAZIONE UNIVERS
WISHBONE LEVER TOOL
EXTRACTOR BRAZO DE SUSPENSION



- Lunghezza: 120cm
- Diametro tubo: 3.5cm
- Distanza fissaggio: 50, 45, 40, 35, 30cm
- Length: 120cm
- Diameter tube: 3.5cm
- Brace distance: 50, 45, 40, 35, 30cm

Tutte le immagini dei prodotti pubblicate in questo catalogo sono puramente indicative e possono essere cambiate senza preavviso.
All product images published in this catalogue have explanatory purposes and can be changed with no warning.



**ATTREZZATURE PER MOTOFFICINE
MOTOR BIKES EQUIPMENT
EQUIPOS PARA MOTOS**



Tutte le immagini dei prodotti pubblicate in questo catalogo sono puramente indicative e possono essere cambiate senza preavviso.
All product images published in this catalogue have explanatory purposes and can be changed with no warning.

Prezzi promozionali / IVA e trasporto non incluso • Promotional prices • Precios promocionales

Cod. 05.085.17

€ 1.360,00

SOLLEVATORE PER MOTO ELETTOIDRAULICO
ELECTROHYDRAULIC MOTO LIFTER
ELEVADOR ELECTROHIDRÁULICO PARA MOTOS



- Capacità di sollevamento / Lifting capacity / Capacidad de levantamiento: **600 kgs**
- Dimensioni piattaforma / Platform dimensions / Dimensiones plataforma: **1800 x 600 mm**
- Lunghezza totale / Total length / Longitud total: **2600 mm**
- Telecomando per salita/discesa / Remote control for raise/descent / Mando a distancia para levantar/bajar: **standard**

- Altezza di sollevamento / Lifting height / Altura levantamiento: **260 – 880 mm**
- Apertura morsa / Vise opening / Anchura prensa: **40 – 200 mm**
- Motore / Motor: **230V 50Hz 550W**
- Dim. imballo / Pack. dim. Peso / Weight: **2070x700x400 mm / 220 kgs**

Cod. 05.085.18

€ 1.680,00

SOLLEVATORE PER MOTO E QUAD ELETTOIDRAULICO
ELECTROHYDRAULIC MOTO & QUAD LIFTER
ELEVADOR ELECTROHIDRÁULICO PARA MOTOS Y QUAD



- Capacità di sollevamento / Lifting capacity / Capacidad de levantamiento: **600 kgs**
- Dimensioni piattaforma / Platform dimensions / Dimensiones plataforma: **1800 x 1200 mm**
- Lunghezza totale / Total length / Longitud total: **2600 mm**
- Telecomando per salita/discesa / Remote control for raise/descent / Mando a distancia para levantar/bajar: **standard**

- Altezza di sollevamento / Lifting height / Altura levantamiento: **260 – 880 mm**
- Apertura morsa / Vise opening / Anchura prensa: **40 – 200 mm**
- Motore / Motor: **230V 50Hz 550W**
- Dim. imballo / Pack. dim. Peso / Weight: **2040x800x400 mm / 300 kgs**

Tutte le immagini dei prodotti pubblicate in questo catalogo sono puramente indicative e possono essere cambiate senza preavviso.
All product images published in this catalogue have explanatory purposes and can be changed with no warning.

Cod. 05.085.04L

€ 570,⁰⁰**PONTE SOLLEVATORE PER MOTO/SCOOTER**

con pompa idraulica a pedale

LIFT FOR MOTORCYCLES/SCOOTERS

equipped with foot hydraulic pump

LEVANTADOR HIDRÁULICO DE PESO

accionado por pie para motos /scooters

- Capacità: 450 Kg
- Altezza min: 18,5 cm
- Altezza max: 85 cm
- Misura piano con rampa laterale: 266x65 cm
- Misura piano: 220x65 cm
- Misura rampa laterale: 60x65 cm
- Dimensione imballi: 224x70x21 cm
- Imballo in legno
- Peso lordo: 167,8kg
- Peso netto: 145,5kg
- Colore: Blu Ral 5015

- Capacity: 450 Kg
- Min.Height: 18,5 cm
- Max.Height: 85 cm
- Table size with side ramp: 266x65cm
- Table size: 220x65cm
- Side ramp size: 60x65cm
- Package size: 224x70x21 cm
- Plywood Cases
- G.W.: 167,8kg
- N.W.: 145,5kg
- Color: Blue Ral 5015

- Capacidad: 450 Kg
- Altura Min.: 18,5 cm
- Altura Max.: 85 cm
- Tamaño de la superficie de apoyo con placa lateral: 266x65cm
- Tamaño de la superficie de apoyo: 220x65cm
- Placa lateral: 60x65 cm
- Tamaño del embalaje: 224x70x21 cm
- Embalaje Plywood
- Peso bruto: 167,8kg
- Peso neto: 145,5kg
- Color: Azul Ral 5015



Cod. 05.085.04C

€ 451,⁰⁰**PONTE SOLLEVATORE PER MOTO/SCOOTER**

con pompa idraulica a pedale

LIFT FOR MOTORCYCLES/SCOOTERS

equipped with foot hydraulic pump

LEVANTADOR HIDRÁULICO DE PESO

accionado por pie para motos /scooters

- Capacità: 360Kg
- Altezza min: 20 cm
- Altezza max: 85 cm
- Misura piano con rampa laterale: 220x49 cm
- Misura piano: 135x49 cm
- Misura rampa laterale: 85x49cm
- Dimensione imballi: 150x80x40 cm
- Imballo in legno
- Peso lordo: 120 kg
- Peso netto: 107 kg
- Colore: Blu Ral 5015

- Capacity: 360 Kg
- Min.Height: 20 cm
- Max.Height: 85 cm
- Table size with side ramp: 220x49 cm
- Table size: 135x49 cm
- Side ramp size: 85x49cm
- Package size: 150x80x40 cm
- Plywood Cases
- G.W.: 120 kg
- N.W.: 107 kg
- Color: Blue Ral 5015

- Capacidad: 360 Kg
- Altura Min.: 20 cm
- Altura Max.: 85 cm
- Tamaño de la superficie de apoyo con placa lateral: 220x49 cm
- Tamaño de la superficie de apoyo: 135x49 cm
- Placa lateral: 85x49cm
- Embalaje Plywood
- Tamaño del embalaje: 150x80x40 cm
- Peso bruto: 120 kg
- Peso neto: 107 kg
- Color: Azul Ral 5015



Cod. 05.087.16

€ 210,⁰⁰**RAMPA IN ALLUMINIO RICHIUDIBILE E TRASPORTABILE****ALUMINUM CLOSABLE AND PORTABLE RAMP****RAMPA DE ALUMINIO RECERRABLE Y PORTÁTIL**

- Portata/ Capacity/ Capacidad: 300 kg
- Dimensioni/dimensions: 185x38x8cm
- Peso/ Weight: 18kg /20,5 kg

300
Kg

Tutte le immagini dei prodotti pubblicate in questo catalogo sono puramente indicative e possono essere cambiate senza preavviso.
All product images published in this catalogue have explanatory purposes and can be changed with no warning.

Prezzi promozionali / IVA e trasporto non incluso • Promotional prices • Precios promocionales

PROMO 2024

127

Cod. 05.085.05

€ 148,⁰⁰

SOLLEVATORE IDRAULICO A PEDALE

per scooter e moto da cross

FOOT HYDRAULIC WEIGHT LIFTER

for scooters and enduros

LEVANTADOR HIDRÁULICO DE PESO ACCIONADO POR PIE

para motos y enduros

- Capacità: 135kgs
- Altezza minima: 340mm
- Altezza massima: 890mm
- Peso: 28,5kgs
- Load range: 135kgs
- Minimum height: 340mm
- Maximum height: 890mm
- Weight: 28,5kgs
- Capacidad: 135kgs
- Altura mínima: 340 mm
- Altura máxima: 890mm
- Peso: 28,5kgs



Cod. 05.085.14

€ 62,⁸⁰

CAVALLETTO DI SOLLEVAMENTO MOTO SU PONTE

MOTO LIFTING EASEL FOR MOTO LIFTER

GATO DE ELEVACIÓN MOTOS PARA LEVANTADORES DE MOTOCICLETAS

- Capacità max: 500 kg
- Altezza max.: 420mm
- Altezza min.: 90mm
- Dim. piattaforma: 450x150mm
- Peso netto: 15KG
- Dim. imballo: 495x310x90mm
- Max.Capacity: 500 kg
- Max.Height:420mm
- Min Height:90mm
- Platform size:450x150mm
- Net weight:15KG
- Carton size:495x310x90mm
- Capacidad max: 500 kg
- Altura max.: 420mm
- Altura min.: 90mm
- Dim. plataforma: 450x150mm
- Peso: 15KG
- Dim. embalaje: 495x310x90mm



Cod. 05.088.128

€ 124,⁰⁰

SET DI 3 CONTENITORI PORTA TUTTO IN TELAIO DI ALLUMINIO

per lavoro - tempo libero - sport

SET OF 3 STORAGE BOXES IN ALUMINUM FRAME

for work - leisure - sport

JUEGO DE 3 CAJAS DE ALMACENAMIENTO CON ESTRUCTURE DE ALUMINIO

para el trabajo - tiempo libre - deporte

- Materiale: alluminio - ABS - 3,9mm MDF + 2mm EVA
- Piccolo: 47,5x26x21 cm
- Medio: 68x31x32 cm
- Grande: 73x38x36 cm
- Non vendibili separatamente
- Dimensioni imballo: 76,5x41x41 cm / peso: 12,7 kg
- Material: aluminum - ABS - 3,9mm MDF + 2mm EVA
- Small: 47.5x26x21 cm
- Medium: 68x31x32 cm
- Large: 73x38x36 cm
- Not for separate sale
- Packaging dimensions: 76.5x41x41 cm / weight: 12.7 kg
- Material: aluminio - ABS - MDF de 3,9 mm + EVA de 2 mm
- Pequeño: 47,5x26x21 cm
- Mediano: 68x31x32 cm
- Grande: 73x38x36 cm
- No para venta separada
- Dimensiones del embalaje: 76,5x41x41 cm / peso: 12,7 kg



Cod. 05.090.62

€ 30,00

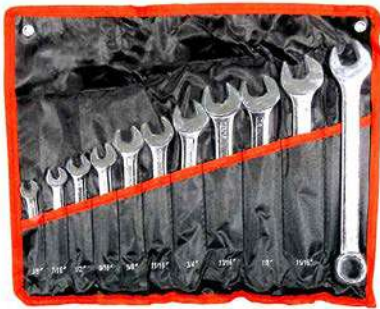
SET 11 CHIAVI COMBinate
KIT OF 11 COMBINED WRENCHES
JUEGO DE 11 LLAVES COMBINADAS

- 3/8"
- 7/16"
- 1/2"
- 9/16"
- 5/8"
- 11/16"
- 3/4"
- 13/16"
- 7/8"
- 5/16"
- 1"

Cod. 05.090.63

€ 28,50

SET PER LA SEPARAZIONE E RIVETTATURA DI CATENE MOTOCICLI
idoneo per catene da 35 a 630
3 punti di separazione (2,2mm, 2,9mm 3,8mm)**SET FOR THE SEPARATION AND RIVETING OF MOTORCYCLES CHAINS**
suitable for chains from 35 to 630
3 points of separation (2.2mm, 3.8mm 2.9mm)**CONJUNTO PARA LA SEPARACIÓN Y EL REMACHADO DE LAS CADENAS DE MOTOCICLETAS**
apto para cadenas de 35 a 630
3 puntos de separación (2,2mm, 3,8mm 2,9mm)

Cod. 05.090.64

€ 69,00

SET 10 ESTRATTORI ROTORE
KIT OF 10 ROTOR'S EXTRACTORS
KIT DE 10 EXTRACTORES ROTOR

(Honda, Suzuki, Yamaha, Bosch, Ducati, Kawasaki)



Cod. 05.090.65

€ 69,00

DISTANZIATORE PER PINZE FRENI
SPACER FOR BRAKE CLAMPS
ESPACIADOR PARA PINZAS FRENO

Cod. 05.085.07

€ 62,00

CAVALLETTO FERMA MOTO
MOTORCYCLE STAND
SOPORTE PARA MOTOCICLETAS

- Portata/capacity/capacidad: 200 kgs
- Dimensioni imballo/packaging dim/dim. del embalaje: 640x540x160mm
- Peso/weight/peso: 11,5kgs

Tutte le immagini dei prodotti pubblicate in questo catalogo sono puramente indicative e possono essere cambiate senza preavviso.
All product images published in this catalogue have explanatory purposes and can be changed with no warning.

Prezzi promozionali / IVA e trasporto non incluso • Promotional prices • Precios promocionales

PROMO 2024

129

CHROME
VANADIUM



Cod. 05.090.49

€ 128,⁰⁰

CHIAVI A BUSSOLA 219 PZ
(1/2" - 3/8" - 1/4")
+ CHIAVI COMBinate

E19PCS 1/2" - 3/8" - 1/4"
DR. SOCKET WRENCH SET
+ COMBINATION SPANNER



72 denti / teeth

CHROME
VANADIUM



Cod. 05.090.17

€ 28,⁰⁰

CASSETTA BUSSOLE 1/4" (46PZ)
46- PCS SOCKET SET, 1/4"

- Bussole "super lock" da 4 a 13mm
- Inserti piani, croce, esagonali e torx
- Cricchetto reversibile a 45 denti
- Realizzato in conformità con le norme DIN
- T-Star kit bussole di diverse misure
- Materiale: cromo vanadio
- Super lock sockets from 4 to 13mm
- Comes with plain slot, cross slot, hexagon and 45 tooth reversible ratchet with quick release button
- Made according to DIN standards
- T-Star prese bit di diverse dimensioni
- Matt chrome vanadium

CHROME
VANADIUM



Cod. 05.090.16

€ 76,⁰⁰

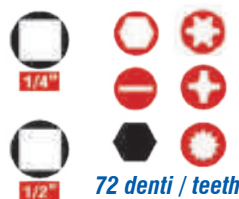

72 denti / teeth

SET BUSSOLE INSERTI DA 1/4" E 1/2" (108 PZ)
108-PCS SOCKET SET, 1/4" AND 1/2"

- 6.3 (1/4) drive:
Ratchet, short extension, long extension, universal joint, sliding T-handle
Super lock sockets in the following sizes: 4-4,5-5-5,5-6-7-8-9-10-11-12-13 and 14mm
Super lock deep sockets in following sizes: 6-7-8-9-10-11-12-13mm
T Star bit sockets: T8-T10-T15-T20-T25-T27-T30
4x cross bit sockets and 3x slot bit sockets
Hex bit sockets: 3-4-5-6mm
E-type sockets: E4-E5-E6-E7-E8

- 12.5 (1/2) drive:
Rauche, short extension, long extension, universal joint, sliding T-handle
Super lock sockets in the following sizes: 10-11-12-13-14-15-16-17-18-19-20-21-22-24-27-30-32mm
Super lock deep sockets in sizes: 14-15-17-19-22mm
1x bit holder
T Star bits: T40-T45-T50-T55-T60
6 x cross bits and 3 slotted bits
Hex bits: 7-8-9-10-12-14mm
E-type sockets:
E10-E11-E12-E14-E16-E18-E20-E24
Spark plug sockets: 16 and 21mm

CASSETTE BASE PER OGNI OFFICINA MECCANICA
BUSSOLE IN ACCIAIO AL CROMO-VANADIO TRATTATO E CROMATO FORNITE IN CASSETTA IN MATERIALE PLASTICO COMPOSITO
BASIC SETS FOR EVERY MECHANICAL WORKSHOP
SOCKETS IN TREATED AND CHROMIUM-PLATED VANADIUM CHROMIUM IN A CASE OF COMPOSITE PLATIC MATERIALS

Cod. 05.089.00

€ **60,00**

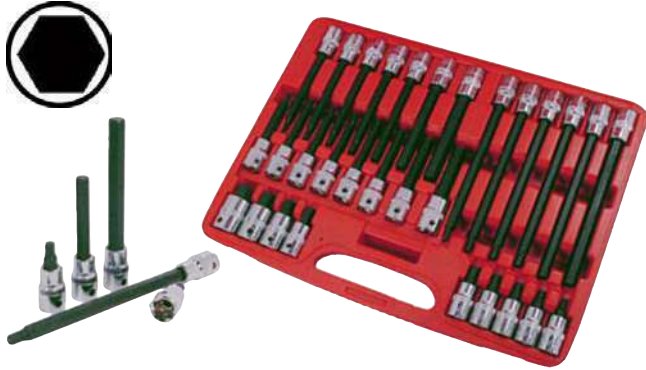

Set 30 pz chiavi bussola con esagono maschio attacco **1/2"**
 Set of 30 pcs exagonal male coupling wrenches

Contenuto - It contains: L 55 mm 5-6-7-8-10-12-14-17-19
 L 100 mm 5-6-7-8-10-11-12-13
 L 140 mm 5-6-8-10-12-14
 L 200 mm 5-6-7-8-10-12

Cod. 05.090.00

€ **57,00**



Set 26 bussole con inserto ZXN **1/2"**
 Set sockets with ZXN insert (26 pieces)

Contenuto - It contains: L 55 mm 5-6-7-8-9-10-12-14-16
 L 100 mm 5-6-8-9-10-12-14
 L 140 mm 5-6-8-9-10-12-14
 L 200 mm 8-10-12-14

Cod. 05.090.01

€ **63,00**



Set 32pz bussole con inserto TX **1/2"**
 Set sockets with TX (32 pieces)

Contenuto It contains: L 55 mm T20-25-27-30-40-45-50-55-60-70
 L 100 mm T20-25-27-30-40-45-50-55-60-70
 L 140 mm T40-45-50-55-60-70
 L 200 mm T40-45-50-55-60-70

Cod. 05.090.02

€ **66,00**



Set 32pz bussole con inserto RIBE **1/2"**
 Set sockets with RIBE (32 pieces)

Contenuto It contains: L 55 mm 5-6-7-8-9-10-12-13-14
 L 100 mm 5-6-7-8-9-10-12-13-14
 L 140 mm 8-9-10-12-13-14

Cod. 05.090.05

€ **89,00**



Set di 15 bussole per lo smontaggio Set of 15 sockets for the dismantling
 Set de 15 boussole pour le démontage

Tutte le immagini dei prodotti pubblicate in questo catalogo sono puramente indicative e possono essere cambiate senza preavviso.
 All product images published in this catalogue have explanatory purposes and can be changed with no warning.

Prezzi promozionali / IVA e trasporto non incluso • Promotional prices • Precios promocionales

PROMO 2024

131

PROMO 2024

Cod. 05.090.104

€ 38,00

KIT 19 BUSSOLE PER SERIE EP TORX
KIT 19 SOCKETS FOR EP TORX SERIES
KIT 19 VASOS PARA SERIE EP TORX



- 5 pz/pcs 1/4" EP 4, 5, 6, 7, 8mm
- 5 pz/pcs 3/8" EP 10, 11, 12, 14, 16mm
- 8 pz/pcs 1/2" EP 18, 20, 22, 24, 26, 28, 30, 32mm
- 1 pz/pc 5 EP8.8, 1/2"
- per rimuovere il coperchio della batteria, compatibile con Tesla
- to remove battery cover, compatible with Tesla
- para quitar la tapa de la batería, compatible con Tesla



Cod. 05.090.52

€ 98,00

SET 13 CHIAVI COMBinate A CRICCHETTO 8÷32 MM
13 COMBINATION SPANNER RATCHETS SET 8÷32 MM
JUEGO DE 13 LLAVES COMBINADAS 8÷32 MM



CHROME
VANADIUM

Cod.05.090.23

€ 16,50

ALLARGAFORI A GRADINI 3 PZ
STEPPED HOLE ENLARGER 3 PCS
ENLARGADORA DE AGUJEROS ESCALONADA



- Ideale per forare lamine di metallo sottili senza deformarle
- Per tutti i tipi di metallo e plastica industriale e lamine fino a 3 mm di spessore
- Contenuto: 1x4-12mm, 1x4-20mm, 1x4-32mm
- Valigetta in legno
- Ideal for drilling thin metal sheets without distorting
- For all types of metal, industrial plastic and sheet metal up to 3 mm thick
- Content: 1x4-12mm, 1x4-20mm, 1x4-32mm
- Wooden cas
- Ideal para la perforación de chapas sin deformarlas
- Para todo tipo de metal, plástico industrial y chapas de hasta 3 mm de espesor
- Contenido: 1x4-12mm, 1x4-20mm, 1x4-32mm
- Caja de maderae

Cod. 05.078.04

€ 47,00

SET CHIAVI COMBinate PER ALTERNATORI (22 PZ)
KIT OF COMBINED WRENCHES FOR ALTERNATORS (22PCS)



APPLICAZIONI / APPLICACION:
ALTERNATORI - ALTERNATORS: BOSCH - DENSO

MARCHI/ BRANDS:
VW - AUDI - MERCEDES BENZ - RENAULT - PEUGEOT CITROEN - BMW -
OPEL - FORD - FIAT - HONDA - PORSCHE



Tutte le immagini dei prodotti pubblicate in questo catalogo sono puramente indicative e possono essere cambiate senza preavviso.
All product images published in this catalogue have explanatory purposes and can be changed with no warning.

Cod. 05.090.26

€ 43,00

KIT 14 CHIAVI A PIPA
14 DOUBLE ENDED OFFSET HEXAGON WRENCHES KIT JUEGO DE
14 LLAVES EXTENSIBLES HEXAGONALES



Cod. 05.090.29B

€ 75,00

IT 7 CHIAVI A "T" SNODATE
7 T-BENDED WRENCHES KIT
JUEGO DE LLAVES DE CUBO A "T"



- Con termoformato
- With thermoformed base
- Con base termoformada
- 7, 8, 10, 11, 13, 15, 17 mm

Cod. 05.090.48

€ 34,00

CRICCHETTO 1/2" ESTENSIBILE
1/2" EXTENDIBLE RATCHET



Cod. 05.090.15

€ 57,00

SET DI 25 CHIAVI COMBinate 6-32MM
25-PCS COMBINATION SPANNER SET, 6-32MM

CHROME
VANADIUM



Set di 25 chiavi combinate 6-32mm

In acciaio al cromo-vanadio
 6-7-8-9-10-11-12-13
 14-15-16-17-18-19-20-21
 22-23-24-25-26-27-28-30-32mm
 Custodia in tetron
 conforme a norma din 3113 A

25-piece Combination Spanner Set, 6-32mm

All parts manufactured from chrom vanadium-steel;
 Hardened, chrome plated
 6-7-8-9-10-11-12-13
 14-15-16-17-18-19-20-21
 22-23-24-25-26-27-28-30-32mm
 Packed in a tetron wallet
 According to DIN 3113 A

Cod. 05.090.14

€ 27,00

SET 12 CACCIAVITI CON ESAGONO ESTERNO
 per una maggior coppia, usando una chiave a bussola

SCREWDRIVER KIT, 12PCS, END-TO-END HEX BLADE
 with outer hexagon for extra torque using a spanner or socket

JUEGO DE 12 DESTORNILLADORES CON HEXÁGONO EXTERNO
 para más torque, usando una llave de tubo



Cod. 05.086.00

€ 139,00

EASY STEP INDUSTRIAL



SCALA PER LA MANUTENZIONE INDUSTRIALE

l'assistenza tecnica in genere

LADDER FOR INDUSTRIAL MAINTENANCE

and general technical assistance

ESCALERA PARA EL MANTENIMIENTO

industrial y la asistencia técnica general

Altezza massima: / Maximum height: Altura máxima:	3,80 mt
Altezza minima: / Minimum height: Altura mínima:	95 cm
Portata: / Capacity: / Capacidad:	150 kg
Peso: / Weight: / Poids:	11 kg



EN131

IN COMPLIANCE WITH
EN CONFORMIDAD CON
EN CONFORMITÉ AVEC
ATTREZZATURE A NORMA



Cod. 05.086.05

€ 109,00

EASY STEP HOME



**SCALA PER USO PRIVATO O PROFESSIONALE
LADDER FOR PRIVATE AND PROFESSIONAL USE
ESCALERA PARA USO PRIVADO Y PROFESIONAL**

Altezza massima: / Maximum height: Altura máxima:	2,60 mt
Altezza minima: / Minimum height: Altura mínima:	83 cm
Portata: / Capacity: / Capacidad:	150 kg
Peso: / Weight: / Poids:	6 kg

EN131 IN COMPLIANCE WITH
EN CONFORMIDAD CON
EN CONFORMITÉ AVEC
ATTREZZATURE A NORMA

- Compatta
- Si chiude e si apre in un minuto
- con dispositivo "salvadita"
- Compact
- Open and close in 1 minute
- With "finger-saving" device
- Compacto
- Se abre y se cierra en 1 minuto
- Con dispositivo de "ahorro de dedos"

Cod. 05.086.11

€ 26,00

3 gradini/steps/escalones

Cod. 05.086.12

€ 45,00

6 gradini/steps/escalones

**SCALA IN ALLUMINIO, TIPO DOMESTICO
ALUMINUM LADDER, HOUSEHOLD TYPE
ESCALERA DE ALUMINIO, TIPO DOMÉSTICO**

	Cod. 05.086.11 3 gradini/steps	Cod. 05.086.12 6 gradini/steps
Dimensioni/dimensions	40,5x61x111 cm	45x85x17,4 cm
Dimensioni imballo/package dim.	118x33x24 cm	181x36,5x24 cm



Tutte le immagini dei prodotti pubblicate in questo catalogo sono puramente indicative e possono essere cambiate senza preavviso.
All product images published in this catalogue have explanatory purposes and can be changed with no warning.



EN131 IN COMPLIANCE WITH EN CONFORMIDAD CON EN CONFORMITÉ AVEC ATTREZZATURE A NORMA

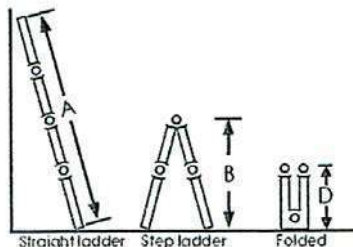

	Cod. 05.086.14	Cod. 05.086.15	Cod. 05.086.16
Gradini/steps	3+3	4+4	5+5
A size	2900	3840	5100
B size	1420	1940	2460
D Size	940	1220	1500
Prezzo promo / Promo price	€ 102,00	€ 122,00	€ 152,00

Cod. 05.087.13

€ **96,00**

EN131 IN COMPLIANCE WITH EN CONFORMIDAD CON EN CONFORMITÉ AVEC ATTREZZATURE A NORMA

PEDANA IN ALLUMINIO
ALUMINIUM PLATFORM
PLATAFORMA DE ALUMINIO

- per carrozzerie, officine meccaniche, artigiani, edilizia, manutentori
- for body parts workshops, mechanic workshops, maintenance technicians
- para chapistas, talleres mecanicos, tecnicos de mantenimiento

Portata:	Load range:	Rango de carga:	200kgs
Dimensioni:	Dimensions:	Dimensiones:	1016x410x585mm
Peso:	Weight:	Peso:	8,5 kgs



Tutte le immagini dei prodotti pubblicate in questo catalogo sono puramente indicative e possono essere cambiate senza preavviso.
All product images published in this catalogue have explanatory purposes and can be changed with no warning.

ACCESSORI SERVIZIO SU VETTURE ELETTRICHE
ACCESSORIES FOR SERVICE ON ELECTRIC VEHICLES
ACCESORIOS PARA EL MANTENIMIENTO EN VEHICULOS ELECTRICOS

Cod. 05.087.07

€ **305,00****CAVALLETTO MONTAGGIO/SMONTAGGIO PORTIERE****UNIVERSAL STAND FOR ASSEMBLING AND DISASSEMBLING CAR DOORS****SOPORTE UNIVERSAL PARA MONTAJE Y DESMONTAJE DE PUERTAS DE COCHE**

- Lunghezza: 580 mm
- Profondità: 540 mm
- Altezza porta min: 1000 mm
- Altezza porta max: 1650 mm
- Corsa di sollevamento: 200 ÷ 600 mm
- Peso: 23 kg

- Length: 580 mm
- Depth: 540 mm
- Min door height: 1000 mm
- Max door height: 1650 mm
- Lifting stroke: 200 ÷ 600 mm
- Weight: 23 kg

- Longitud: 580 mm
- Profundidad: 540 mm
- Altura de la puerta min: 1000 mm
- Altura máxima de la puerta: 1650 mm
- Carrera de elevación: 200 ÷ 600 mm
- Peso: 23 kilos



Cod. 05.088.148

€ **320,00****CAVALLETTO UNIVERSALE PER VERNICIATURA CERCHIONI****UNIVERSAL SUPPORT FOR WHEEL RIM PAINTING****SOPORTE UNIVERSAL PARA PINTAR LLANTAS**

- Lunghezza: 1690 mm
- Profondità: 1160 mm
- Altezza min: 865 mm
- Peso: 44 kg

- Length: 1690 mm
- Depth: 1160 mm
- Min height: 865 mm
- Weight: 44 kg

- Longitud: 1690 mm
- Profundidad: 1160 mm
- Altura de la puerta min: 865 mm
- Peso: 44 kg

LAMPADE POLIMERIZZATRICI A INFRAROSSI AD ONDE CORTE CON SUPPORTO

ideale per riparazioni circoscritte, asciugatura del motore, rimozione di strisce adesive, asciugatura di stucco o primer e preriscaldamento prima della spruzzatura. Il telaio regolabile in altezza consente di eseguire lavori su tutte le parti del veicolo.

SHORT-WAVE INFRARED POLYMERIZING LAMPS WITH SUPPORT

ideal for small repairs, engine drying, removing adhesive strips, drying putty or primer and preheating before spraying. the height-adjustable frame allows to work on all parts of the vehicle.

Cod. 05.087.08

€ 387,00



- Voltaggio: 220V-240V 50/60HZ
- Potenza di avvio: 2 × 1100 W
- Temperatura: 40°C-100°C
- Impostazione tempo: 0-60 min.
- Area riscaldamento: 800*800 mm
- Peso netto/lordo: 20,5/21,5 kg

- Voltage: 220V-240V 50/60HZ
- Boot Power: 2×1100W
- Temperature: 40°C-100°C
- Time setting: 0-60min.
- Baking Area size: 800*800mm
- Net/Gross weight: 20,5/21,5 kg



Cod. 05.087.09

€ 653,00



Pannello di controllo computerizzato automatico con display digitale, timer elettronico, le icone mostrano la percentuale di potenza, pulsazioni, settaggio delle luci, la protezione da sovraccarico di sicurezza

- Voltaggio: 220V-240V 50/60HZ
- Potenza di avvio: 3 × 1100 W
- Temperatura: 40°C-100°C
- Area riscaldamento: 1200*1000 mm
- Peso netto/lordo: 51/52 kg

Automatic computer control panel with digital display electronic timer, the icons show the percentage of power, pulse function, snorkels, the lamp set of lights, safety overload protection

- Voltage: 220V-240V 50/60HZ
- Boot Power: 3×1100W
- Temperature: 40°C-100°C
- Baking Area size: 1200*1000 mm
- Net/Gross weight: 51/52 kg



3 SET EVA PER STRUMENTI ISOLATI PER I LAVORI SU VETTURE IBRIDE (CONFORME IEC 60900)
3 EVA SETS FOR INSULATED TOOLS FOR SERVICE ON HYBRID CARS (ACCORDING TO IEC 60900)
3 JUEGOS DE HERRAMIENTAS AISLADAS PARA EL MANTENIMIENTO EN COCHES HÍBRIDOS (SEGÚN IEC 60900)

Cod. 05.090.99

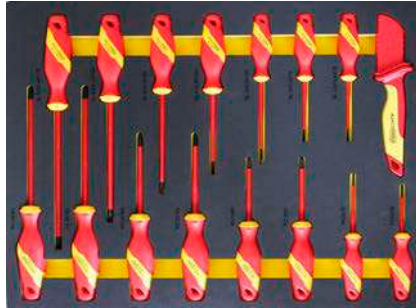
€ **480,00**HYBRID
CARS

1	Insulated Combination Pliers, 200mm		22	1/2" Insulated Sockets 10mm				
2	Insulated Wire Stripping Pliers, 160mm		23	1/2" Insulated Sockets 11mm				
3	Insulated Flat Nose Pliers, 200mm		24	1/2" Insulated Sockets 12mm				
4	Insulated High Leverage Long Snipe Nose Pliers, 200mm		25	1/2" Insulated Sockets 13mm				
5	Insulated Cable Cutting Pliers, 160mm		26	1/2" Insulated Sockets 14mm				
6	Insulated Slotted Screwdriver, 2.5*0.4*75mm		27	1/2" Insulated Ratchet Wrench 250mm				
7	Insulated Slotted Screwdriver 3*0.5*75mm		28	1/2" Insulated Extension Bar 125mm				
8	Insulated Slotted Screwdriver 3*0.5*100mm		29	1/2" Insulated Extension Bar 250mm				
9	Insulated Slotted Screwdriver 4*0.8*100mm			30	Insulated Ring Wrench 6mm			
10	Insulated Slotted Screwdriver 5.5*1*125mm			31	Insulated Ring Wrench 7mm			
11	Insulated Slotted Screwdriver 6.5*1.2*150mm			32	Insulated Ring Wrench 8mm			
12	Insulated Slotted Screwdriver 8.0*1.6*175mm			33	Insulated Ring Wrench 9mm			
13	Insulated Phillips Screwdriver PH0*75mm			34	Insulated Ring Wrench 10mm			
14	Insulated Phillips Screwdriver PH1*80mm			35	Insulated Ring Wrench 11mm			
15	Insulated Phillips Screwdriver PH2*100mm			36	Insulated Ring Wrench 12mm			
16	Insulated Phillips Screwdriver PH3*150mm			37	Insulated Ring Wrench 13mm			
17	Insulated Pozidriv Screwdriver PZ0*60mm				38		Insulated Ring Wrench 14mm	
18	Insulated Pozidriv Screwdriver PZ1*80mm				39		Insulated Ring Wrench 15mm	
19	Insulated Pozidriv Screwdriver PZ2*100mm	40	Insulated Ring Wrench 16mm					
20	Insulated Pozidriv Screwdriver PZ3*150mm	41	Insulated Ring Wrench 17mm					
21	VDE Insulated Cable Knife 190mm/208mm (52mm blade)		42		Insulated Ring Wrench 18mm			
			43	Insulated Ring Wrench 19mm				

Tutte le immagini dei prodotti pubblicate in questo catalogo sono puramente indicative e possono essere cambiate senza preavviso.
 All product images published in this catalogue have explanatory purposes and can be changed with no warning.

Cod. 05.088.55X € **308,00**

VUOTO / EMPTY / VACIO



+

Cod. 05.090.99 € **480,00**

3 EVA SET



=

€ **788,00**



Cod. 03.036.01 € **1.141,00**

**RECUPERATORE CARBURANTI (BENZINA/GASOLIO) 90 LT
90 LT FUEL (PETROL/DIESEL) RECOVERY DEVICE
RECUPERADOR DE COMBUSTIBLES (GASOLINA/GASÓLEO), 90 LT**

- Capacità: 90lt
- Serbatoio carrellato in acciaio inox
- Funzionamento con sistema Venturi (A)
- Aspira e scarica il carburante in pochi minuti
- Dispositivo per recupero vapori (B)
- Dimensioni: 530x530x1100mm
- Peso 28.3 kg
- Capacity: 90lt
- 90lt Stainlesssteel tank with trolley
- Functioning with Venturi system (A)
- It drains and discharges the fuel in a few minutes
- Device to recover vapours (B)
- Dimensions: 530x530x1100mm
- Weight: 28.3 kg
- Capacidad: 90lt
- Depósito de acero inoxidable 90lt con carro
- Funcionamiento con sistema Venturi (A)
- Drena y descarga el combustible en pocos minutos.
- Dispositivo para recuperar vapores (B)
- Dimensiones: 530x530x1100 mm
- Peso: 28,3 kg



Cod. 04.013.05 € **30,00**

**TERMOMETRO DIGITALE A RAGGI INFRAROSSI
con puntatore laser (-50°/+400°)**

**DIGITAL INFRARED THERMOMETER
with laser pointer (-50°/+400°)**

**TERMÓMETRO DIGITAL DE RAYOS INFRARROJOS
con puntador laser (-50°/+400°)**

- Misura della temperatura senza contatto
- Spegnimento automatico
- Grado di emissività regolabile 0,95 (fisso)
- Rapporto distanza-dimensioni: 12:1
- Data hold

- Non-contact temperature measurement
- Auto Power Off
- Adjustable emissivity: from 0,95 (fixed)
- Distance spot ratio: 12:1
- Data hold

- Medición de la temperatura sin contacto
- Apagado automático
- Grado de emisión regulable 0,95 (fijo)
- Relación distancia-dimensiones: 12:1
- Data hold



Tutte le immagini dei prodotti pubblicate in questo catalogo sono puramente indicative e possono essere cambiate senza preavviso.
All product images published in this catalogue have explanatory purposes and can be changed with no warning.

Cod. 05.090.100

€ 520,00

CASSETTIERA PORTAUTENSILI ISOLATI per i lavori su
vetture ibride (57 utensili inclusi)**TOOL CHEST OF DRAWERS FOR INSULATED TOOLS**
suitable for work on hybrid vehicles (57 tools incl.)**CAJONERA PARA HERRAMIENTAS AISLADAS** para trabajar
en vehículos híbridos (57 utensilios incl.)CONFORME
COMPLIANT WITH
IEC 60900

Set di cacciaviti e pinze isolati VDE (11 pz) 11 pcs VDE insulated Tool Set Screwdrivers&Pliers		1 taglierina laterale VDE da 6" 1 pinza combinata VDE da 7" 1 pinza a becchi lunghi VDE da 8" 7 cacciaviti VDE: SL3*75mm, SL4.0*100mm, SL5.5*125mm, SL6.5*150mm, PH0*75mm, PH1*80mm, PH2*100mm 1 tester tensione: 140 mm, CA 200-250 V	1pc 6" VDE Side Cutter 1pc 7" VDE Combination Plier 1pc 8" VDE Long Nose Plier 7pc VDE Screwdriver: SL3*75mm, SL4.0*100mm, SL5.5*125mm, SL6.5*150mm, PH0*75mm, PH1*80mm, PH2*100mm 1pc Voltage tester:140mm,AC 200-250V
Set di 11 cacciaviti isolati VDE Slim Fix 11 pcs Slim Fix VDE Insulated Screwdrivers Set		Dimensioni testa: PZ1*80 mm, PZ2*100 mm, PH1*80 mm, PH2*100 mm, 4,0 mm*100 mm, 5,5 mm*125 mm, 6,5 mm*150 mm, 3,5 mm*100 mm, T15*100 mm, T20*125 mm, T25*125 mm	Head size: PZ1 x 80 mm, PZ2 x 100 mm, PH1 x 80 mm, PH2 x 100 mm, 4.0 mm x 100 mm, 5.5 mm x 125 mm, 6.5 mm x 150 mm, 3.5 mm x 100 mm, T15*100mm, T20 x125mm, T25 x 125mm
Bussole 1/2 e chiave inglese (20pz) 20pcs VDE Insulated Tool Set 1/2 Sockets&Wrench		13 prese VDE da 1/2": 10 mm, 11 mm, 12 mm, 13 mm, 14 mm, 16 mm, 17 mm, 18 mm, 19 mm, 21 mm, 22 mm, 24 mm, 27 mm 4 punte a bussola VDE da 1/2": H4*80mm, H5*80mm, H6*80mm, H8*80mm 1 barra di estensione VDE da 1/2": 250 mm 1 impugnatura a T VDE da 1/2": 200 mm 1 chiave a cricchetto VDE da 1/2": 250 mm	13pc 1/2" VDE sockets: 10mm, 11mm, 12mm, 13mm, 14mm, 16mm, 17mm, 18mm, 19mm, 21mm, 22mm, 24mm, 27mm 4pc 1/2" VDE Socket Bits: H4*80mm, H5*80mm, H6*80mm, H8*80mm 1pc 1/2" VDE Extension Bar: 250mm 1pc 1/2" VDE T Handle: 200mm 1pc 1/2" VDE Ratchet Wrench: 250mm
Set di chiavi esagonali (7pz) 7pcs VDE Insulated Hex Key set		Chiave esagonale isolata VDE (in cromo vanadio). Dimensioni: 3 mm, 4 mm, 5 mm, 6 mm, 8 mm, 10 mm, 12 mm	VDE certified insulated Hex Key. Manufactured from chrome vanadium. Hex Key Size: 3mm, 4mm, 5mm, 6mm, 8mm, 10mm, 12mm
Set di chiavi ad anello (8pz) 8pcs VDE Insulated Ring Spanner Set		Chiavi ad anello isolate VDE Dimensioni: 7 mm, 8 mm, 10 mm, 12 mm, 13 mm, 14 mm, 17 mm, 19 mm	VDE certified insulated Ring Spanner Size: 7mm, 8mm, 10mm, 12mm, 13mm, 14mm, 17mm, 19mm

Tutte le immagini dei prodotti pubblicate in questo catalogo sono puramente indicative e possono essere cambiate senza preavviso.
All product images published in this catalogue have explanatory purposes and can be changed with no warning.

Prezzi promozionali / IVA e trasporto non incluso • Promotional prices • Precios promocionales

PROMO 2024

141

ATTREZZI PER LA MESSA IN SICUREZZA POSTAZIONE DI LAVORO SU VETTURE IBRIDE
ACCESSORIES FOR SECURING THE WORK AREA ON HYBRID VEHICLES
ACCESORIOS PARA LA PUESTA EN SEGURIDAD DEL AREA DE TRABAJO EN VEHÍCULOS HÍBRIDOS

Cod. 01.000.336

€ 76,⁰⁰



TAPPETO ALTO ISOLAMENTO (A METRAGGIO)
INSULATED FLOOR MAT

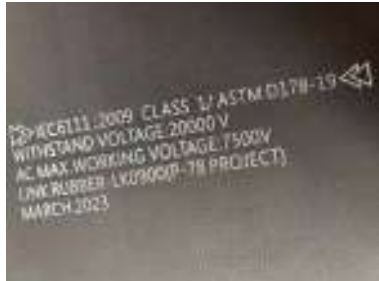

- Dimensioni: 1 x 0,6 m
- Spessore: 4 mm
- Materiale: miscela di butadiene benzene naturale
- Peso: 4-4,2 kg
- CEI 61111:2009 CLASSE 1
- Resistenza alla tensione: 20000 V
- Tensione max AC: 7500 V
- Size: 1m x 0.6m
- Thickness: 4mm
- Material: Natural butadiene benzene mixture
- Weight: 4-4.2kg
- IEC 61111:2009 CLASS 1
- Withstand voltage: 20000V
- AC Max working voltage: 7500V

Cod. 01.000.339

€ 82,⁰⁰



PALO DI SOCCORSO ANTISHOCK
INSULATED RESCUE HOOK



Lunghezza / Length: 150cm



Il palo di soccorso anitshock viene utilizzato per rimuovere da una posizione pericolosa una persona colpita o ferita da scossa elettrica

Un lavoratore infortunato potrebbe trovarsi in luoghi pericolosi quali spazi ristretti, veicoli elettrici, veicoli ibridi e apparecchiature elettriche. Il materiale isolante protegge il soccorritore dalle scosse elettriche.

Rescue Hook is used to remove a person incapacitated by electrical shock or injured from a hazardous location.

An injured worker could be located in dangerous locations such as confined spaces, electric vehicles, hybrid vehicles and electrical equipment. The insulating material protects the rescuer from electric shock.



Cod. 01.000.337

€ 74,⁰⁰

Maschera facciale per protezione elettrica
Electrical protection face mask
Máscara facial de protección eléctrica



Cod. 01.000.335

€ 64,⁰⁰

Guanti isolanti per protezione elettrica
Insulating gloves for electrical protection
Guantes aislantes para protección eléctrica



Cod. 01.000.338

€ 39,⁹⁰

KIT DELIMITAZIONE PER AREA MANUTENZIONE VEICOLI ELETTRICI
DELIMITATION KIT FOR ELECTRIC VEHICLES' MAINTENANCE AREA
KIT DE DELIMITACIÓN PARA ZONA DE MANTENIMIENTO DE VEHÍCULOS ELÉCTRICOS

- 4 colonne porta catena. Colore giallo-nero, con base riempibile con acqua o sabbia
- 2 pannelli di segnalazione inclusi
- 4 chain-holder columns. Yellow-black colour, with base that can be filled with water or sand
- 2 signboards included
- 4 columnas porta cadenas. Color amarillo-negro, con base que se puede rellenar con agua o arena
- 2 letreros incluidos



Cod. 01.000.333

€ 19,⁹⁵

Catena in plastica L=25mt, Ø6mm per cod. 01.000.332
Plastic chain L=25mt, Ø6mm for cod. 01.000.332
Cadena de plástico L=25mt, Ø6mm para cod. 01.000.332



Cod. 01.000.334

€ 0,⁶⁵

Set di ganci per catena 01.000.333
Set of hooks for chain 01.000.333
Juego de ganchos para cadena 01.000.333

Tutte le immagini dei prodotti pubblicate in questo catalogo sono puramente indicative e possono essere cambiate senza preavviso.
All product images published in this catalogue have explanatory purposes and can be changed with no warning.



Cod. 05.092.01

€ 16,⁸⁰

SET 11 UTENSILI SMONTA-ACCESSORI
KIT OF 11 TOOLS FOR DISASSEMBLING REMOVABLE ACCESSORIES
KIT DE 11 HERRAMIENTAS PARA DESMONTAR LOS ACCESORIOS REMOVIBLES

- SET SMONTATUTTO
11 utensili in plastica molto resistente, consentono di togliere tutti gli accessori smontabili dal veicolo senza graffiare le parti relative e la vernice.
- UNIVERSAL DEMOUNTING SET
11 high-resistant plastic devices that enable you to remove all the demountable accessories from the vehicle without scratching the parts and the paint.
- JUEGO DE HERRAMIENTAS DE DESMONTAJE
11 dispositivos de plástico de alta resistencia que le permiten eliminar todos los accesorios desmontables desde el vehículo sin rayar las partes y la pintura.

Cod. 05.087.10

€ 38,⁵⁰

CAVALLETTO APPOGGIA CRISTALLI

SAW-HORSE FOR WINDOWS

CABALLETE PARA APODA CRISTALES

Cod. 05.087.13

€ 96,⁰⁰

PEDANA IN ALLUMINIO
ALUMINIUM PLATFORM
PLATAFORMA DE ALUMINIO

- per carrozzerie, officine meccaniche, artigiani, edilizia, manutentori
- for body parts workshops, mechanic workshops, maintenance technicians
- para chapistas, talleres mecanicos, tecnicos de mantenimiento



EN131 IN COMPLIANCE WITH EN CONFORMIDAD CON EN CONFORMITE AVEC ATTREZZATURE A NORMA

Portata:	Load capacity:	Rango de carga:	200 kg
Dimensioni:	Dimensions:	Dimensiones:	960x300x480 mm
Dim. imballo:	Pack. dim.:	Dim. embalaje:	1016x410x585 mm
Peso:	Weight:	Peso:	8,5 kg

Cod. 05.087.02

€ 178,⁰⁰

CAVALLETTO ESTENSIBILE MULTIUSO
EXTENDIBLE MULTI-PURPOSE SAWHORSE
CABALLETE EXTENSIBILE MULTIUSO



- Piani di lavoro rivestiti in gomma antiscivolo
- Regolazione in altezza (fino a 132cm), 2 ruote con freno
- Regolabile in apertura (da 22,5 cm chiuso a 138cm completamente aperto)
- Portata 100kg
- Ideale come supporto di appoggio per officine, carrozzerie, laboratori di assemblaggio in genere
- Nei momenti di non uso occupa uno spazio di 0,2m²

- Working surface covered with non slip rubber
- Adjustable height (up to 132cm), 2 wheels with brake
- Adjustable opening (from 22,5 cm closed to 138cm completely open)
- Capacity 100kg
- Ideal as a support for workshops, car body repairers' and assembling laboratories
- When closed it takes 0,2m²

- Tablero de trabajo con cobertura de caucho antideslizante
- Altura ajustable (hasta 132cm), 2 ruedas con freno
- Abertura ajustable (desde 22,5 cm cerrado hasta 138cm completamente abierto)
- Capacidad 100kg
- Ideal como soporte para talleres, chapistas, laboratorios de ensamblaje
- Cuando no se utiliza ocupa un espacio de 0,2m²

Tutte le immagini dei prodotti pubblicate in questo catalogo sono puramente indicative e possono essere cambiate senza preavviso.
 All product images published in this catalogue have explanatory purposes and can be changed with no warning.

Cod. 05.008.01

€ 6,⁵⁰



VASSOIO MAGNETICO DOPPIO
DOUBLE MAGNETIC PART DISH
BANDEJA MAGNÉTICA DOBLE

• 240x140 mm

Cod. 05.064.00

€ 84,⁰⁰

KIT SMONTAGGIO/MONTAGGIO PARABREZZA

Il kit include: 2 coppie di ventose oscillanti, 2 coppie di maniglie tirafilo, 1 attrezzo inseritore filo, 1 cinghia a cricchetto, 1 matassa di filo a sezione quadra.

KIT FOR MOUNTING AND DISMOUNTING WINDSCREENS

The kit includes: 2 couples of swivelling vacuum cups, 2 couples of wire gripping handles, wire feeder tool, 1 ratchet, steel square wire.

KIT PARA MONTAR Y DESMONTAR PARABRISAS

El kit incluye: 2 pares de ventosas oscilantes, 2 pares de asas tirahilos, 1 herramienta para introducir el hilo, 1 correa con carraca, 1 madeja de hilo de sección cuadrada.



Cod. 05.013.03

€ 5,⁹⁵



COPERTURA PARAFANGO MAGNETICA

Protegge la carrozzeria da graffi e urti accidentali. In panno e neoprene. Dimensioni: 110x40cm

WORKSHOP WING COVER WITH MAGNETS

It protects the car wing from scratches and accidental damage. Cloth and neoprene. Dimensions: 110x40cm

CUBIERTA GUARDABARROS MAGNÉTICA

Protege el guardabarros de arañazos y daños accidentales. Paño y neopreno. Dimensiones: 110x40cm

Cod. 05.090.22

€ 11,⁰⁰

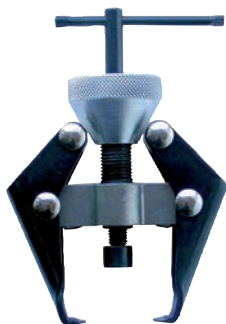

ESTRATTORE PER TERMINALI BATTERIA
E BRACCI TERGICRISTALLI

TWO LEG PULLER FOR BATTERY TERMINALS
AND WIDESCREEEN WIPE ARMS

TIRADOR A DOS PIERNAS PARA TERMINALES
DE LA BATERÍA Y DEL LIMPIAPARABRISA

12V

Cod. 04.042.00

€ 29,⁰⁰

24V

Cod. 04.042.01

€ 29,⁰⁰



SOPPRESSORE DI IMPULSI
IMPULSE SUPPRESSOR
SUPRESOR DE IMPULSOS

Protegge gli impianti di iniezione e accensione elettronica da picchi di tensione durante i lavori di saldatura in carrozzeria: si monta tra + e - della batteria.

It protects electronic injection and ignition from voltage peaks during welding operations in workshops. It has to be installed between the + and - of the battery.

Protege la ignición y la inyección electrónica de picos de tensión durante las operaciones de soldadura en talleres. Tiene que ser instalado entre el + y - de la batería.

Cod. 05.062.04

€ 14,⁰⁰

SET DI 4PCS DI PINZE PER MICRO SALDATURA

SET OF 4PCS MICRO WELDING CLAMPS

JUEGO DE 4PCS ABRAZADERAS PARA MICRO-SOLDADURA



Cod. 05.062.03

€ 13,⁹⁰

PINZA CON TESTA ORIENTABILE PER ESTRAZIONE TAPPI IN PLASTICA
CLAMP WITH ADJUSTABLE HEAD FOR EXTRACTING PLASTIC CAPS
ABRAZADERA CON CABEZA AJUSTABLE PARA LA EXTRACCIÓN
DE TAPONES DE PLÁSTICO





Cod. 05.090.85

€ 18,00

SPESIMETRI PER CARROZZERIA

a 10 lame con ventosa di fissaggio (2 pz)
per posizionamento cristalli

10-BLADE BODY THICKNESS GAUGES

with fixing suction cup (2 pcs) for windows positioning

MEDIDORES DE ESPESOR DE CARROCIERIA

de 10 cuchillas con ventosa de fijación (2 piezas)
para el posicionamiento de cristales



Cod. 05.074.05

€ 128,00

MISURATORE SPESSORE VERNICI**DIGITAL PAINT THICKNESS INDICATOR****INDICADOR DIGITAL ESPESOR DE PINTURA**

- Utilizzabile su superfici in acciaio e alluminio
- **Campo di misura: 0-5000 µm**
- Precisione: +/- 10 mm
- Riconoscimento automatico del supporto
- Sonda esterna con tastatore adatta anche a superfici irregolari
- 2 kit di calibrazione
- Fabbricato in UE
- It can be used on aluminum and steel surfaces
- **Measuring range: 0-5000 µm**
- Precision: +/- 10mm
- Automatic detection of the material
- External probe, it can be used on irregular surfaces
- 2 calibration kits
- Made in EU
- Se puede utilizar sobre superficies de aluminio y acero
- **Intervalo de medida: 0-5000 µm**
- Precisión: +/- 10 mm
- Detección automática del material
- Sonda externa, se puede utilizar en superficies irregulares
- 2 kit de calibracion
- Fabricado en la UE

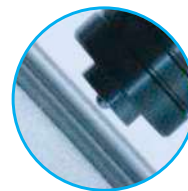

Cod. 05.090.25

€ 31,50

KIT SMONTAGGIO AIRBAG (12 PZ.)**12 PCS. AIR BAG REMOVAL TOOL SET AIRBAGS****KIT PARA DESMONTAR EL AIRBAG (12 PZAS.)**

Cod. 05.066.02

€ 56,00

2000W

**SET SVERNICIATORE****PAINT REMOVER SET****SET PARA ELIMINACION DE PINTURA**

2 velocità / 2 speeds / 2 velocidades de:
300 ° C - 600 ° C

Flusso d'aria / Air flow / Flujo de aire:
500l/min - 650l/min

Potenza / Power / Alimentación:
2 kW 230V 50Hz

Imballo / Packaging / Embalaje: 10 Kg



CARATTERISTICHE TECNICHE:

- Le normative rispettate dal prodotto: IEC61672, ISO-9001, CE, IEC1010
- Misuratore del livello sonoro di classe 1
- Diametro esterno microfono standard 0.5" Costanti di tempo Slow e Fast
- Funzionamento facile ed innovativo,
- per la configurazione del software non è necessario il computer, il fonometro è dotato di serie di una memory card SD per il registro dei dati
- (anno /mese /giorno /ora /minuti /secondi) che si introduce nel lettore del computer per la lettura in formato Excel, l'utente può effettuare le ulteriori analisi grafici.

TECHNICAL FEATURES:

- Frequency and time weighting Class 1
- weighting networks comply with standards IEC61672, ISO-9001, CE, IEC1010

0.5" standard microphone head
Memory function to store the Max. & Min. value
Hold and Peak Hold functions
Innovation and easy operation, computer is not need to setup extra software, after execute data logger, just take away the SD card from the meter and plug in the SD card into the computer, it can download all the measured values with the time information (year/month/date/hour/minute/second) to the Excel directly, then user can make the further data or graphic analysis by themselves

Measurement range: 30 - 130 dB
Resolution: 0.1 dB
Function: dB (A & C frequency weighting Time weighting (Fast,Slow), Peak hold, Data hold, Record (Max., Min.)
Calibration VR: Build in external calibration VR, easy to calibrate on 94 dB level by screw driver. Calibrated via external SOUND CALIBRATOR (optional)
Weight: 489 g/1,08 LB
Dimension: 245 x 68 x 45 mm
Accessories Included: instruction manual, hard carrying case, CA-06
Optional accessories: Sound wind shield ball sound calibrator (94 dB)
SD Card (2GB)
USB cable, USB-01
Data acquisition software, SW-U801-WIN.

Cod. 04.019.02

€ 576,⁰⁰

FONOMETRO DIGITALE CLASSE 1
con SD card e uscita USB

DIGITAL SOUND LEVEL METER
with SD Card real time data logger

SONÓMETRO DIGITAL

tarjeta SD registradora de datos en tiempo real

Campo di misura: 30 - 130 dB
Risoluzione: 0.1 dB
Funzioni: dB (ponderazione A e C, costanti di tempo Fast e Slow, Hold Peak, Data Hold, Record (max, min)
Taratura VR: taratura VR esterna integrata, facile da calibrare a 94 dB con il cacciavite. Taratura tramite calibratore acustico esterno (a richiesta)
Peso: 489 g / 1,08 LB
Dimensioni: 245 x 68 x 45 mm
Accessori inclusi: manuale d'uso, valigetta rigida di trasporto, CA-06
Accessori opzionali: Calibratore del livello sonoro (94 dB)
Cuffia antivento
SD card (2 GB)
Cavo USB, USB-01
Software di acquisizione dati, SW-U801-WIN

CARACTERÍSTICAS TÉCNICAS:

Frecuencia y ponderación temporal Clase 1
Las redes son compatibles con las normas IEC61672, ISO-9001, CE, IEC1010
Cabeza 0.5" de micrófono
Función de memoria para memorizar el valor Max y Min.
Función de "Pico" y "Mantenimiento Pico"
Innovación y operatividad fácil, el ordenador no necesita de un software adicional, después de ejecutar el registro de datos, simplemente quite la tarjeta SD del medidor y la conecte al ordenador, se pueden descargar directamente todos los valores de medición con la información del tiempo (Año /mes /día /hora /minuto /segundo) en Excel, entonces el usuario puede procesar en datos o hacer un análisis gráfico por sí mismo

Rango de medición: 30 - 130 dB
Resolución: 0,1 dB
Función: dB (A & C ponderación de frecuencia y tiempo (rápido, lento) Retención de pico, Retención de datos, Registro (Máx., Mín.)
Calibración VR: calibración externa en VR ya incluida, fácil calibración del nivel en 94 dB por destornillador. Calibrado mediante calibrador de sonido externo (opcional)
Peso: 489 g / 1,08 LB
Dimensiones: 245 x 68 x 45 mm
Accesorios incluidos: Manual de instrucciones estuche rígido CA-06
Accesorios opcionales: Bola quitavientos de sonido Calibrador acústico (94 dB)
Tarjeta SD (2GB)
Cable USB, USB-01
Software de adquisición de datos, SW-U801-WIN



Cod. 04.018.05

€ 321,⁰⁰

FONOMETRO CLASSE 2 CON RS232 SOUND LEVEL METER CLASS 2 WITH RS232
FONÓMETRO CLASE 2 CON RS232

Cod. 04.018.06

€ 65,⁰⁰

CAVETTO UPCB-2 PER FONOMETRO SL 4012, INCL. SOFTWARE
UPCB-2 CABLE FOR THE SOUND LEVEL METER SL 4012, INCL. SOFTWARE
CABLE UPCB-2 PARA FONÓMETRO SL 4012 CON SOFTWARE INCLUIDO

Tutte le immagini dei prodotti pubblicate in questo catalogo sono puramente indicative e possono essere cambiate senza preavviso.
All product images published in this catalogue have explanatory purposes and can be changed with no warning.

EXTRACTOR 2000

Cod. 03.032.01

€ **858,00**

ASPIRATORE GAS CARRELLATO PER AUTO, FURGONI, CAMION
WHEELED GAS ASPIRATOR FOR CARS, VANS, TRUCKS

CARATTERISTICHE TECNICHE

- Capacità di aspirazione: 2000 mc/h
- Potenza del motore: 1,1 kw
- Altezza massima (dal centro della bocchetta): 650 mm
- Altezza minima (dal centro della bocchetta): 350 mm
- Ø Bocchetta: 235 mm
- Ø Tubo gas: 152 mm
- Lunghezza del tubo flessibile: 10 mt
- Temperatura max. del tubo flessibile: 150°

TECHNICAL FEATURES

- Aspiration capacity: 2000 mc/h
- Engine Power: 1,1 kw
- Maximum Height (from the center of the nozzle): 650 mm
- Minimum Height (from the center of the nozzle): 350 mm
- Ø Nozzle: 235 mm
- Ø Expulsion gas hose: 152 mm
- Length of Expulsion gas hose: 10 mt
- Max t° of expulsion gas hose: 150°



Bocchetta per auto/furgoni/camion
Cars/ vans / trucks nozzle

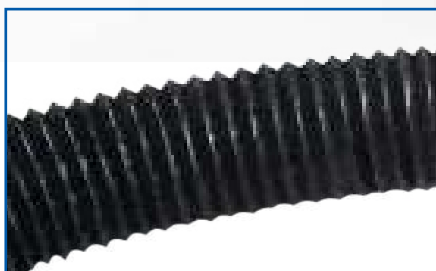

Tubazione di uscita 10 m/Ø 152mm
10 m / Ø 152mm Outlet hose



Tutte le immagini dei prodotti pubblicate in questo catalogo sono puramente indicative e possono essere cambiate senza preavviso.
All product images published in this catalogue have explanatory purposes and can be changed with no warning.

Prezzi promozionali / IVA e trasporto non incluso • Promotional prices • Precios promocionales

PROMO 2024

147

Cod. 05.066.06PRO

€ 449,⁰⁰

INDUCTOR BASIC 1 KW

IN VALIGETTA DI TRASPORTO IN ALLUMINIO • CON 5 SPIRALI INCLUSI
IN ALUMINUM CASE • WITH 5 HEATING COILS INCLUDED



LO SAPEVI CHE È PROIBITO IL RISCALDAMENTO CON FIAMME LIBERE?

DID YOU KNOW THAT HEATING WITH OPEN FLAMES IS PROHIBITED?



Riscaldamento ad induzione è un metodo senza contatto che può essere usato per riscaldare i metalli. Il riscaldatore ad induzione crea un campo magnetico alternato che genera correnti indotte all'interno del materiale. Sono queste correnti indotte che generano calore.

L'assenza di fiamme libere rende il lavoro più sicuro assicurando allo stesso tempo sicurezza e risparmio economico. Permette di lavorare anche vicino a parti sensibili al calore.

Induction heating is a contactless method that can be used to heat metals. The induction heater creates an alternating magnetic field that generates currents induced within the material. They are these induced currents that generate heat.

The absence of open flames makes the work safer while ensuring economic safety and savings. Allows you to work even close to parts sensitive to heat.



INDUCTION

Cod. 05.066.29PRO

€ 569,⁰⁰**INDUTTORE 1,5 KW CON RAFFREDDAMENTO AD ARIA**

con 5 spirali

1.5 KW INDUCTOR WITH AIR COOLING

with 5 spirals



- Alimentazione: 240V AC50/60Hz
- Frequenza uscita induzione: 25-65kHz
- Potenza massima in uscita: <2,0 kW
- Fattore di potenza: 0,99 (PFC)
- Tempo di riscaldamento continuo e costante
- Spina tipo E 220/240 V 50/60Hz
- 5 spirali (bobina flessibile Ø 30/40/50 mm e tipo piatto)
- Lunghezza cavo spina: 150 cm
- Lunghezza cavo di induzione in uscita: 80 cm
- Con custodia in alluminio
- Dimensioni imballo: 44 x 37 x 14 cm
- Peso: 5,5kg

- Power supply: 240V AC50/60 Hz
- Induction output frequency: 25-65 kHz
- Maximum output power: <2.0 kW
- Continuous and constant heating time
- Plug type E 220/240 V 50/60Hz
- 5 coils (Ø 30/40/50 mm flexible coil and flat type)
- Plug cable length: 150cm
- Output induction cable length: 80cm
- With aluminium carrying case
- Packaging dim: 44 x 37 x 14cm
- Weight: 5.5 kg



Tutte le immagini dei prodotti pubblicate in questo catalogo sono puramente indicative e possono essere cambiate senza preavviso.
All product images published in this catalogue have explanatory purposes and can be changed with no warning.

Prezzi promozionali / IVA e trasporto non incluso • Promotional prices • Precios promocionales

PROMO 2024

149

Cod. 05.066.30

€ 1.950,00

INDUTTORE PORTATILE 3,5 KW
PORTABLE 3.5 KW INDUCTOR

NEW!
2024



- Alimentazione: 230V AC50/60Hz
- Gamma frequenze uscita induttiva: 18-60 kHz
- Consumo: 16A
- Sistema di protezione: IP22
- Frequenza di lavoro: 18-60kHz
- Regolazione potenza: 10-100%
- Lunghezza cavo induttore: 2 mt
- Potenza di ingresso; 3,5 kW
- Potenza di induzione in uscita: 3,5 kVA
- Capacità serbatoio refrigerante: 2,5 lt
- Dimensioni: 24 x 20 x 44 cm
- Peso: 13,5kg

- Power supply: 240V AC50/60 Hz
- Induction output frequency: 18-60 kHz
- Consumption: 16A
- Protective system: IP22
- Working frequency: 18-60kHz
- Output power control: 10-100%
- Inductor cable length: 2 m
- Input power; 3,5 kW
- Output induction power: 3,5 kVA
- Coolant capacity: 2,5Lt
- Dimentions: 24 x 20 x 44cm
- Weight: 13,5 kg

ACCESSORI A RICHIESTA / OPTIONAL ACCESSORIES

Cod. 05.066.23

€ 100,00

Liquido refrigerante per impianto di raffreddamento induttori, 20 lt
Coolant for inductor cooling system, 20 lt



Cod. 05.066.30.R1

€ 136,00

Puntale verticale
Straight coil



Cod. 05.066.30.R2

€ 136,00

Puntale inclinato
Inclined coil



Cod. 05.066.30.R3

€ 136,00

Puntale laterale
Side coil



Cod. 05.066.30.R4





€ 136,00

Puntale tondo, 33 mm
33 mm circle coil



Tutte le immagini dei prodotti pubblicate in questo catalogo sono puramente indicative e possono essere cambiate senza preavviso.
All product images published in this catalogue have explanatory purposes and can be changed with no warning.

INDUTTORI DI CALORE
HEATING INDUCTORS

 MADE IN ITALY DATI TECNICI TECHNICAL FEATURES				
	Hi 3.7	Hi 5.5	Hi 13	Hi 18
Modello / Model	Cod. 05.066.11	Cod. 05.066.13	Cod. 05.066.27	Cod. 05.066.28
Max potenza / Max. power	3.7 Kw 16A	5 Kw 16A	13 Kw 32A	18 Kw 32A
Alimentazione / Power supply	230V single phase	400V 3ph	400V 3ph	400V 3ph
Frequenza regolabile (kHz) Frequency range (kHz)	15 ÷ 30 kHz	15 ÷ 30 kHz	15 ÷ 30 kHz	15 ÷ 30 kHz
Duty cycle	15'	30'	45'	60'
Cavo induttore Inductor cable length	4 mt	4 mt	4 mt	4 mt
Cavo alimentazione Power supply cable length	9 mt	9 mt	9 mt	9 mt
Capacità serbatoio Tank capacity	20 lt	20 lt	20 lt	20 lt
Raffreddamento a liquido Cooling system	✓	✓	✓	✓
Tastiera / Keyboard	✓	✓	✓	✓
Connessione elettrica Electrical connection	IEC 60309	IEC 60309	IEC 60309	IEC 60309
Dimensioni / Dimensions, cm	80 x 80 x 115	80 x 80 x 118	80 x 83 x 135	80 x 83 x 135
Peso / Weight, kg)	50 kg	67 kg	120 kg	130 kg
APPLICAZIONE / APPLICATION				
Carrozzerie / Car Body Shops	x	—	—	—
Gommisti / Tyre Shops	xxx	—	—	—
Meccanica auto / Car Mechanics	xxx	xx	—	—
Agri	xx	xxx	xxx	x
Autocarri/movimento terra Trucks/earth moving vehicles	—	x	xxx	xxx
Manutenzione/Industria/Nautica Trucks/earth moving vehicles	—	—	xxx	xxx
Prezzo promo / Promo price	a richiesta / on request	a richiesta / on request	a richiesta / on request	a richiesta / on request

ACCESSORI A RICHIESTA / OPTIONAL ACCESSORIES (prezzi a richiesta / prices on request)

Hi 3.7 / Hi 5.5		Hi13		Hi18
	Cod. 05.066.14 Puntale laterale Lateral operating tool		Cod. 05.066.19 Puntale laterale Lateral operating tool	Cod. 05.066.28.R1
	Cod. 05.066.15 Puntale verticale Vertical operating tool		Cod. 05.066.20 Puntale verticale Vertical operating tool	Cod. 05.066.28.R2
	Cod. 05.066.16 Ferrite per puntale laterale Ferrite for lateral operating tool		Cod. 05.066.21 Ferrite per puntale laterale Ferrite for lateral operating tool	Cod. 05.066.28.R3
	Cod. 05.066.17 Ferrite per puntale verticale Ferrite for vertical operating tool		Cod. 05.066.22 Ferrite per puntale verticale Ferrite for vertical operating tool	Cod. 05.066.28.R4

Tutte le immagini dei prodotti pubblicate in questo catalogo sono puramente indicative e possono essere cambiate senza preavviso.
All product images published in this catalogue have explanatory purposes and can be changed with no warning.

Cod. 04.052.07

€ 32,00

RILEVATORE DIGITALE

cercametalli e rilevatore di cavi elettrici AC

DIGITAL FINDER

for metal, ac wiring, wood

DETECTOR DIGITAL

de metales y detector de cables electricos AC



- Display LCD con indicatore acustico
- Individua rivestimenti di legno fino a 38mm
- Individua tubi in metallo fino a 76mm
- Individua cavi elettrici (AC) fino a 76mm
- Autocalibrazione
- Alimentazione: 1 batteria 9V (non fornita)
- Confezione in blister
- LCD display and audio indicator
- Wood detection up to 38mm
- Metal pipes detection up to 76mm
- AC live wires detection up to 76mm
- Auto calibration
- Power supply: 6F 22 9V battery (not supplied)
- Blister packaging
- Pantalla LCD con indicador acústico
- Localiza revestimientos de madera de hasta 38 mm
- Localiza tuberías de metal de hasta 76mm
- Localiza cables eléctricos (A/A) de hasta 76mm
- Autocalibración
- Alimentación: 1 batería de 9V (no incluida)
- Envase en lamina al vacio

Cod. 04.014.02

€ 298,00

TERMO CAMERA A RAGGI INFRAROSSI

INFRARED THERMAL IMAGING CAMERA

CÁMARA DE IMÁGENES TÉRMICAS INFRARROJOS



Foto indicativa
Indicative picture

- Display: 2.4"
- Risoluzione di immagine: 0.3 mega pixel
- Sensibilità termica: 0.5°C
- Range di temperatura: -20°/+400°C
- Memorizzazione immagini: scheda SD (4G)
- Tipo di batteria: 4*1.5 V AA (non incluse)
- Tempo di spegnimento automatico: 12 min.
- Dimensioni: 212x90x62mm
- Peso: 231 gr
- Dimensioni confezione: 270x190x110mm
- Display: 2.4"
- Image resolution: 0.3 mega pixels
- Thermal sensitivity: 0.5°C
- Temperature range: -20°/+400°C
- Image storage: SD card (4G)
- Battery type: 4*1.5V AA (not included)
- Automatic switch-off time: 12 minutes
- Dimensions: 212x90x62mm
- Weight: 231 gr
- Package size: 270x190x110mm
- Pantalla: 2.4"
- Resolución de la imagen: 0.3 megapíxeles
- Sensibilidad térmica: 0.5°C
- Rango de temperatura: -20°/+400°C
- Almacenamiento de imágenes: tarjeta SD (4G)
- Tipo de batería: 4*1.5V AA (no incluidas)
- Tiempo de apagado automático: 12 minutos
- Dimensiones: 212x90x62 mm
- Peso: 231 gr
- Tamaño del paquete: 270x190x110mm

CAMPI DI UTILIZZO • FIELDS OF USE • CAMPOS DE USO



Manutenzione del motore dell'automobile
Car engine maintenance
Mantenimiento del motor del coche



Manutenzione dell'impianto aria condizionata
Air conditioning maintenance
Mantenimiento del sistema de aire acondicionado



Manutenzione della linea del trasformatore
Transformer line maintenance
Mantenimiento de la línea del transformador

Tutte le immagini dei prodotti pubblicate in questo catalogo sono puramente indicative e possono essere cambiate senza preavviso.
All product images published in this catalogue have explanatory purposes and can be changed with no warning.

Cod. 01.000.258

€ 156,⁰⁰**CERCAFUGHE PER GAS COMBUSTIBILI**
LEAK DETECTOR FOR FLAMMABLE GASES
DETECTOR DE FUGAS PARA GASES INFLAMABLES**II CERCAFUGHE GAS COMBUSTIBILE**

è progettato come un rilevatore di gas combustibile ad alte prestazioni. L'unità è costruita con sensori e microprocessori a gas semiconduttori di nuova concezione per fornire un'affidabile elaborazione del segnale digitale. Il livello di sensibilità della perdita regolabile e 7 indicatori visivi a LED offrono agli utenti anche la facilità e la convenienza delle operazioni.

CARATTERISTICHE TECNICHE:

- Controllo a microprocessore con elaborazione avanzata del segnale digitale
- Display a colori
- Selettore di sensibilità perdite alto/basso
- Indicazione di batteria scarica
- Sensore di gas a semiconduttore
- Rilevazione di benzina, propano, gas naturale, olio combustibile, ecc
- Sonda inossidabile flessibile da 39 cm
- Fonte di perdite di riferimento inclusa
- Ripristino della concentrazione ambientale

Specifiche:

- Gas misurabili: benzina, propano, gas naturale, olio combustibile, ecc
- Sensibilità: variabile, a partire da 5ppm (benzina)
- Metodo di allarme: allarme acustico, indicatore a LED
- Lunghezza del tubo di rilevamento: 390mm
- Tempo di riscaldamento: 90 sec
- Batteria: 1,5 V AA x 4
- Dimensioni: 173 x 66 x 56 mm
- Peso: 400gr

CARACTERÍSTICAS TÉCNICAS:

- Control por microprocesador con procesamiento de señal digital avanzado
- Pantalla en colores
- Selector de sensibilidad alta/baja de fugas
- Indicación de batería baja
- Sensor de gas por semiconductor
- Detección de gasolina, propano, gas natural, fuel oil, etc.
- Sonda inoxidable flexible de 39 cm
- Fuente de fuga de referencia incluida
- Restauración de la concentración ambiental

The **COMBUSTIBLE GAS LEAK DETECTOR** is designed as a high performance flammable gas detector. The unit is built with newly developed semiconductor gases sensors and microprocessors to provide reliable digital signal processing. The adjustable level of leak sensitivity and 7 LED visual indicators also provide for easy and convenient operations for the users.

TECHNICAL FEATURES:

- Control por microprocesador con procesamiento avanzado de señal digital.
- Pantalla a color
- Selector de sensibilidad de fuga alta/baja
- Indicación de batería baja
- Sensor de gas semiconductor
- Detección de gasolina, propano, gas natural, fuel oil, etc.
- Sonda flexible de acero inoxidable de 39cm
- Referencia sobre la fuente de fuga incluida
- Restauración de la concentración ambiental

Specifications:

- Gases detectables: gasolina, propano, gas natural, fuel oil, etc.
- Sensibilidad: variable, a partir de 5ppm (gasolina)
- Método de alarma: alarma acústica, indicador LED
- Longitud del tubo de detección: 390mm
- Tiempo de calentamiento: 90 seg.
- Batería: 1.5V AA x 4
- Dimensiones: 173x66x56 mm.
- Peso: 400gr

II DETECTOR DE GAS COMBUSTIBLE

está diseñado como un detector de gas combustible de alto rendimiento. La unidad está construida con sensores de gas semiconductor y microprocesadores recientemente desarrollados para proporcionar un procesamiento de señal digital confiable. El nivel de sensibilidad de fugas ajustable y los 7 indicadores visuales LED también proporcionan operaciones fáciles y convenientes a los usuarios.

Tutte le immagini dei prodotti pubblicate in questo catalogo sono puramente indicative e possono essere cambiate senza preavviso.
All product images published in this catalogue have explanatory purposes and can be changed with no warning.



Cod. 04.051.00

€ 39,00

REFRATTOMETRO MULTIFUNZIONI
MULTIFUNCTION REFRACTOMETER
RÉFRACTOMÈTRE MULTIFONCTIONS

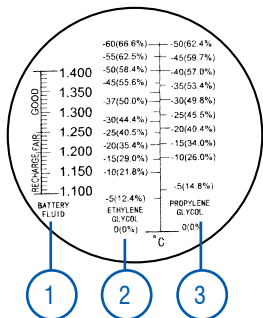

Uno strumento professionale per il controllo di:

- densità dell'acido della batteria
- punto di congelamento del liquido refrigerante del motore
- punto di congelamento del liquido lavavetri

A professional instrument to test:

- Density of acid batteries
- Freezing point of windsceen liquid
- Freezing point of refrigerant liquid of motor

Un instrumento profesional para controlar:

- densidad del ácido de la batería
- punto de congelación del líquido refrigerante del motor
- punto de congelación del líquido lavaparbrisas

1

- Acido Batteria
- Battery acid
- Ácido de las baterías

2

- Liquido Antigelo
- Antifreezing liquid
- Líquido anticongelante

3

- Liquido Lavavetri
- Freezing point of windscreen liquid
- Líquido lavaparbrisas

Cod. 04.051.01

€ 42,00

REFRATTOMETRO PER UREA
REFRACTOMETER FOR UREA
REFRACTOMETRE POUR UREE

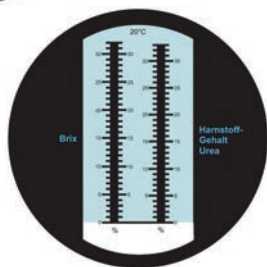

Permette di rilevare la concentrazione dell'urea nei serbatoi di autocarri dotati di dispositivo antinquinamento (AD BLUE)

- 2 scale 0-32%
- Brix graduation 0,2%,
- 0-33% urea 0,2%
- Compensazione automatica della temperatura

It enables to assess the urea concentration in the tanks of the trucks equipped with an anti-pollution device (AD BLUE).

- 2 scales 0-32%
- Brix graduation 0,2%,
- 0-33% urea 0,2%
- Automatic compensation of the temperature

Permite detectar la concentración de urea en los tanques de los camiones equipado con un dispositivo anticontaminación (AD BLUE).

- 2 escalas 0-32%
- Brix graduation 0,2%,
- 0-33% urea 0,2%
- Compensación automática de la temperatura

Cod. 04.051.02NEW

€ 239,00



REFRATTOMETRO DIGITALE PER AD BLUE (UREA)
DIGITAL REFRACTOMETER FOR AD BLUE (UREA)
REFRACTOMETRE DIGITAL POUR AD BLUE (UREA)



- misura gradi brix
- misura temperatura (°C/F)
- zero setting
- auto power off

- measure of brix gradutaion
- temperature measure (°C/F)
- zero setting
- auto power off

- medición grados brix
- medición temperatura
- ajuste cero)
- autoapagaminento

Tutte le immagini dei prodotti pubblicate in questo catalogo sono puramente indicative e possono essere cambiate senza preavviso.
All product images published in this catalogue have explanatory purposes and can be changed with no warning.

PROMO 2024

Cod. 01.000.260

€ 470,00

GENERATORE DI FUMO PER INDIVIDUAZIONE PERDITE
SMOKE LEAK DETECTOR
DETECTOR DE FUGAS POR HUMO

CARATTERISTICHE TECNICHE:

- Risparmio di tempo e maggiore efficienza per trovare le perdite in qualunque tipo di circuito clima (ad esempio impianti di refrigerazione), circuito aria, turbo, marmitte catalizzatori, filtri antiparticolato, testate motore
- Ampia dotazione di adattatori (tappi fissi e universali con pompa)
- Alimentazione: 12V da batteria con pinze
- Flusso d'aria: 6l/min
- 2 modalità del test in pressione: con aria o con fumo
- Alimentazione d'aria incorporata
- 2 flaconi di prodotto

Specifiche:

1. Gancio per una facile movimentazione
2. Misuratore di tenuta visiva per il rilevamento rapido di perdite
3. Manometro incorporato nel circuito chiuso
4. Regolatore di flusso di uscita fumi
5. Indicatore di livello del liquido
6. Interruttore di comando laterale, consente di tagliare la fornitura riempita a metà
7. Sistema multi-adattatore per adattarsi a tutti i tipi di fori
8. Dimensioni: 275 x 220 x 235 mm
9. Peso: 5 kg

TECHNICAL FEATURES:

- Time saving and greater efficiency to find leaks in any type of air-conditioning circuit (e.g. refrigeration systems), air circuit, turbo, catalyysts, particle filters, engine heads
- Wide range of adapters (fixed and universal plugs with pump)
- Power supply: 12V from battery with clamps
- Air flow: 6lt/min
- 2 pressure test modes: with air or with smoke
- Built-in air supply
- 2 bottles of product

Specifications:

1. Hook for easy handling
2. Visual seal gauge for rapid leak detection
3. Pressure gauge built into the closed circuit
4. Smoke outlet flow regulator
5. Liquid level indicator
6. Side control switch, allows you to cut the half-filled supply
7. Multi-adapter system to adapt to all types of holes
8. Dimensions/weight: 275 x 220 x 235 mm / 5kgs

CARACTERÍSTICAS TÉCNICAS:

- Ahorro de tiempo y mayor eficiencia para encontrar fugas en cualquier tipo de circuito de aire acondicionado (p. ej., sistemas de refrigeración), circuito de aire, turbo, catalizadores, filtros de partículas, cabezas de motores
- Amplia gama de adaptadores (enchufes fijos y universales con bomba)
- Alimentación: 12V de batería con pinzas
- Flujo de aire: 6lt/min
- 2 modos de prueba de presión: con aire o con humo
- Suministro de aire incorporado
- 2 botellas de producto

Especificaciones:

1. Colgador de sujeción para un fácil manejo
2. Medidor de estanqueidad visual para detección rápida de pérdida
3. Medidor de presión en el circuito cerrado incorporado
4. Regulador de flujo de salida de humo
5. Indicador de nivel de líquido
6. Interruptor de funcionamiento lateral, permite cortar el suministro a medio relleno
7. Sistema multi-adaptador para encajar en todo tipo de orificios
8. Dimensiones/peso: 275 x 220 x 235 mm / 5 kg

Cod. 01.000.261

€ 10,00

PRODOTTO FUMIGANTE (500ML)**MACHINE OIL (500ML)****BOTELLA DE ACEITE (500ML)**

Tutte le immagini dei prodotti pubblicate in questo catalogo sono puramente indicative e possono essere cambiate senza preavviso.
All product images published in this catalogue have explanatory purposes and can be changed with no warning.

Prezzi promozionali / IVA e trasporto non incluso • Promotional prices • Precios promocionales



ACCESSORI AUTO/CASA CAR/HOME ACCESSORIES

Cod. 05.073.29

€ 21,00

LAMPADA FRONTALE con batterie ricaricabili a ioni di litio
FRONT LAMP with rechargeable lithium ion batteries

DATI TECNICI:

- 5W di potenza lampada frontale
- 3W di potenza luce posteriore
- 4 modalità di regolazione: lampada frontale (100%, 50%, 25%, OFF)
- Autonomia: 100% 2,5-3h; 50% 5-7h; 25% >10h

Principali applicazioni

- Settore "bike"
- Settore trekking e climbing
- Cantieristica in genere
- Protezione civile
- Antinfortunistica

TECHNICAL FEATURES:

- 5W of power - front lamp
- 3W of power - rear light
- 4 adjustment modes: front lamp (100%, 50%, 25%, OFF)
- Autonomy: 100% 2.5-3h; 50% 5-7h; 25% > 10h

Principali applicazioni

- Bike sector
- Trekking and climbing sector
- Building industry in general
- Civil protection
- Accident prevention



Cod. 05.073.28

€ 16,90

LAMPADA A LUCE SOLARE DA PARETE, con sensore di movimento
SUNLIGHT LAMP WALL MOUNTED with motion sensor

DATI TECNICI:

- Pannello solare da 5,5V/0,6W/ Efficienza 17%
- Batteria al litio 3,7V/1800mAh
- Rileva presenza di persone da 3 a 6mt
- Luminosità: 450 lumen
- Potenza: COB LED 10W
- Grado di isolamento: IP65
- Dimensioni: 153x105x49mm
- Peso: 237gr

TECHNICAL FEATURES:

- Solar panel 5.5V / 0.6W / 17% efficiency
- 3.7V / 1800mAh lithium battery
- It detects the presence of people from 3 to 6mt
- Brightness: 450 lumens
- Power: COB LED 10W
- Degree of insulation: IP65
- Dimensions: 153x105x49mm
- Weight: 237gr



Cod. 05.073.46

€ 12,50

SFERA DI LUCE CON MAGNETE
MAGNETIC LIGHT SPHERE

DATI TECNICI:

- Sfera magnetica orientabile a 360°
- 3 posizioni:
luce centrale, luce totale, spenta
- Luminosità: 250 lumen
- Alimentazione: 3 x batterie 1,5V stilo (non include)

TECHNICAL FEATURES:

- 360° adjustable magnetic sphere
- 3 positions:
central light, total light, off
- Brightness: 250 lumen
- Power supply: 3 x 1,5V stylus batteries (not included)



Tutte le immagini dei prodotti pubblicate in questo catalogo sono puramente indicative e possono essere cambiate senza preavviso.
All product images published in this catalogue have explanatory purposes and can be changed with no warning.

ARREDO PER OFFICINA • WORKSHOP FURNITURE • MUEBLES DE TALLER

Cod. 05.088.142

€ 1.250,00

FINE SERIE
SELL OUT

BUDGET



Disponibile solo in colore rosso-nero
In black-red color available only

SET DI 107 UTENSILI INCLUSO
SET OF 107 TOOLS INCLUDED

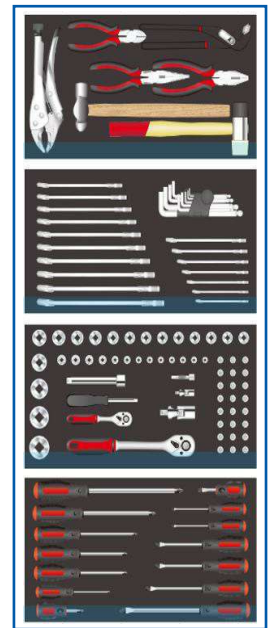

1. Armadio a due porte, 3 ripiani, con 4 piedini regolabili
2. Carrello estraibile con 4 cassetti, completo di 4 eva tools con 107 utensili (pagina 2)
3. Carrello estraibile con 1 cassetto e 2 sportelli
4. Piano in legno multistrato, tavolo con 4 piedini regolabili
5. 6 pannelli forati portautensili
6. 2 sportelli con anta apribile
7. 2 ripiani porta oggetti

1. Two-door cabinet , 3 shelves, 4 feet adjustable in height
2. 4 drawers trolley with 107 tools on 4 eva supports included (page 2)
3. 2 doors trolley with 1 drawer
4. Plywood workbench, 4 feet adjustable in height
5. 6 perforated tool panels
6. 2 wall cabinets with door
7. 2 shelves

Dimensioni / dimensions:

1. 760x495x1960 (2056,5 with foot) mm
2. 616,5x330,3x800,4 mm
3. 616,5x330,3x800,4 mm
4. 1600x500x826,5 (863 with foot) mm
5. 398x19,5x600 mm
6. 400x198x600 mm
7. 798x20x178 mm

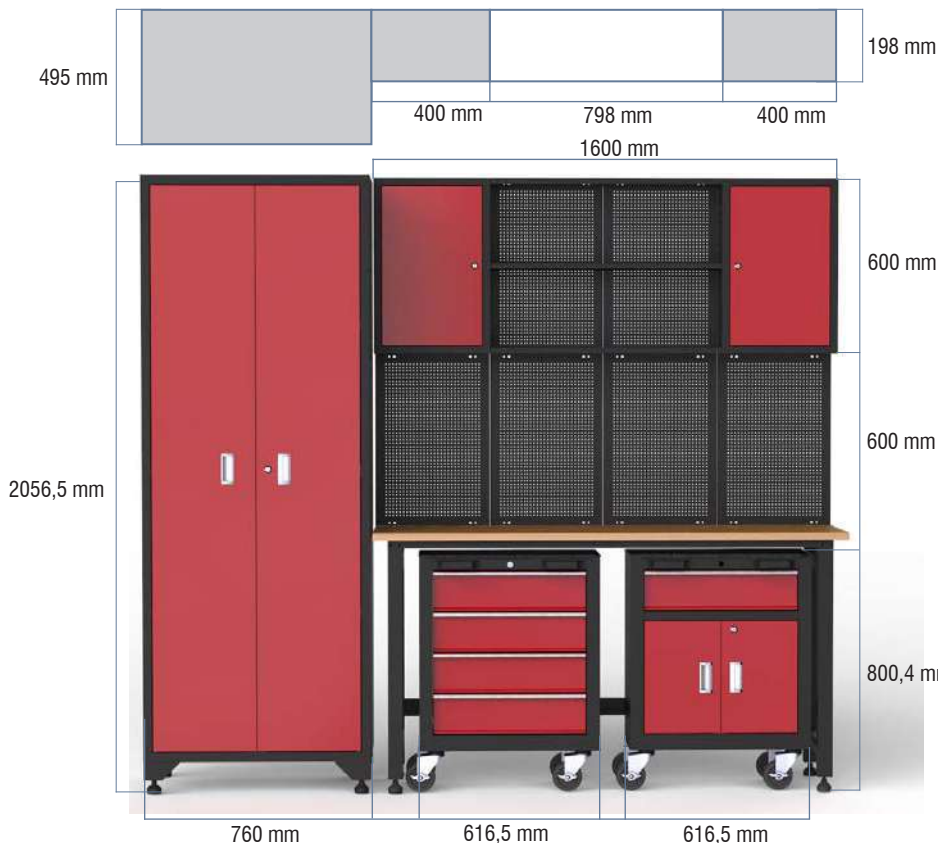

1 PALLET

120 x 80x 223 cm
Net/gross: 124/141 kg



Tutte le immagini dei prodotti pubblicate in questo catalogo sono puramente indicative e possono essere cambiate senza preavviso.
All product images published in this catalogue have explanatory purposes and can be changed with no warning.

Prezzi promozionali / IVA e trasporto non incluso • Promotional prices • Precios promocionales

SET DI 107 UTENISLI CON SUPPORTI IN GOMMA INCLUSI NEL KIT 05.088.142
SET OF 107 TOOLS WITH RUBBER SUPPORTS INCLUDED IN KIT 05.088.142

Cod. 05.088.147

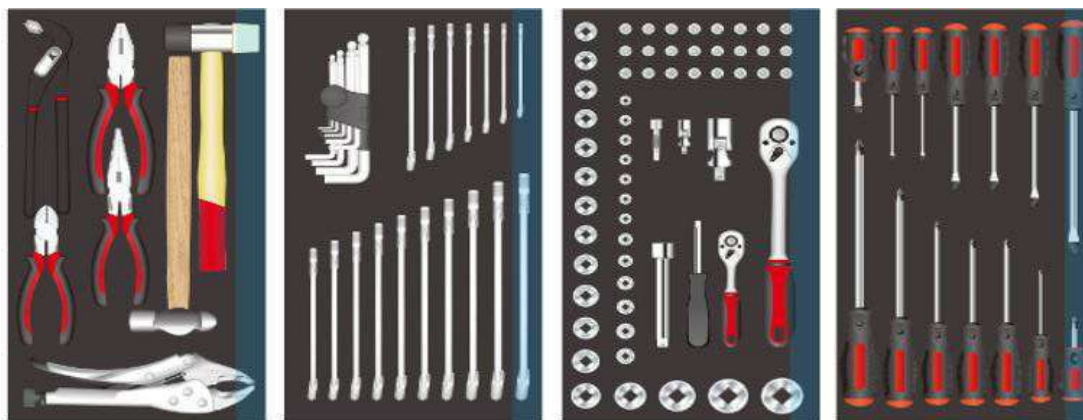

1° cassetto 1st Tray	14 pz/pcs	7pcs	SL Screwdriver	SL 6*38MM-8*175MM-3*75-6*150MM-5*75-4*100MM-5*100MM
2° cassetto 2nd Tray	60 pz/pcs	7Pcs	PH Screwdriver	PH0*75-PH1*100MM-PH2*100-PH2*125-PH3*150--PH2*38-PH4*200
		17Pcs	1/2" Socket	10-11-12-13-14-15-16-17-18-19-21-22-23-24-27-30-32MM
		1Pcs	1/2"	1/2"universal joint
		1Pcs	1/2"	1/2" extension Bar-125MM
		1Pcs	1/2"	1/2"ratchet Handle -72T
		13Pcs	1/4" Socket	4-4.5-5-5.5-6-7-8-9-10-11-12-13-14MM
		1Pcs	1/4"	1/4"universal joint
		1Pcs	1/4"	1/4" extension bar:50mm
		1Pcs	1/4"	1/4"ratchet Handle -72T
		1Pcs	1/4"	1/4"Socket Holder/Spinder handle
3° cassetto 3rd Tray	26 pz/pcs	23pcs	1/4"Socket Bit	T8-10-15-20-25-27-30-40-PH1-2-3,PZ1-2-3,SL4-4.5-7,H3-4-5-6-7-8
		17pcs	6-22mm Combination Wrench	6-7-8-9-10-11-12-13-14-15-16-17-18-19-20-21-22mm
		9Pcs	Ball Point Hex Key sets	1.5-2-2.5-3-4-5-6-8-10MM
4° cassetto 4th Tray	7 pz/pcs	1Pcs	40mm	40mm Rubber Mallet
		1Pcs	500g	500g Machinist Hammer
		1Pcs	8"	Combination Pliers
		1Pcs	8"	Long nose Plies
		1Pcs	7"	Diagonal Pliers
		1Pcs	10"	Locking Pliers
		1Pcs	10"	D4 Groove joint Pliers



Tutte le immagini dei prodotti pubblicate in questo catalogo sono puramente indicative e possono essere cambiate senza preavviso.
All product images published in this catalogue have explanatory purposes and can be changed with no warning.

ACCESSORI PER BICI E MOUNTAIN BIKE ACCESSORIES FOR BIKES AND MOUNTAIN BIKES



Cod. 05.088.126

€ 24,00

RASTRELLIERA PER 2 CICLI
2 BIKE FLOOR STAND
APARCAMIENTO PARA 2 BICILETAS



- Costruzione in tubolari in acciaio
- Dimensioni (montata): 600x540x570mm
- Per ruote fino a 63 mm di larghezza
- Adatto per bici con freno a disco
- Peso netto: 4 kg

- Tubular steel construction
- Opened size: 600x540x570mm
- Holds tires up to 63 mm thick
- Suitable for bikes with disc brake
- Net weight: 4 kgs

- Construcción de acero tubular
- Dimensión (montado): 600x540x570mm
- Para ruedas de hasta 63 mm de ancho
- Apto para bicicletas con freno de disco
- Peso neto: 4 kgs



Cod. 05.088.134

€ 37,50

PORTABICI POSTERIORE PER AUTO/FURGONI
REAR BIKE RACK FOR CARS / VANS
PORTABICILETAS TRASERO PARA COCHES / FURGONETAS



- Dim. tubo tondo in acciaio 25x1,5 mm;
- Dimensioni: 65X60X50 cm,
- Finitura verniciata a polvere
- 6 cinghie fissano il portapacchi al veicolo
- Può contenere tre pezzi di biciclette
- Capacità massima: 60 kg

- Steel round tube size 25x1.5mm
- Size:65X60X50cm
- Powder coated finish
- 6 straps to secure the bike carrier
- It can carry up to three bicycles
- Max Capacity:60kg

- Tamaño de tubo de acero redondo 25x1,5 mm
- Dimensiones: 65X60X50 cm
- Acabado con recubrimiento en polvo
- 6 correas para asegurar el portabicicletas al vehículo
- Puede transportar hasta tres bicicletas.
- Capacidad máxima: 60 kg



Cod. 05.090.97

€ 42,00

SET DI 44 UTENSILI
PER RIPARAZIONE CICLI E M.BIKE

44 PCS BICYCLE TOOL SET

CAJA DE 44 HERRAMIENTAS
PARA REPARACIÓN DE BICICLETAS



Tutte le immagini dei prodotti pubblicate in questo catalogo sono puramente indicative e possono essere cambiate senza preavviso.
All product images published in this catalogue have explanatory purposes and can be changed with no warning.

Prezzi promozionali / IVA e trasporto non incluso • Promotional prices • Precios promocionales

PROMO 2024

159

ACCESSORI PER BICI E MOUNTAIN BIKE ACCESSORIES FOR BIKES AND MOUNTAIN BIKES

Cod. 05.088.153

€ 70,⁰⁰

CAVALLETTO RIPARAZIONE BICICLETTE BIKE REPAIR STAND FOR MAINTENANCE SOPORTE DE REPARACIÓN DE BICICLETAS



NEW!
2024

- Applicazione: biciclette da 20" a 29"
- Materiale: alluminio + acciaio + PA + TPE
- Peso: 2,6 kg
- Altezza regolabile: 68~93cm
- Ripiegabile (salvaspazio)
- Pinza rotante a 360°
- Pinza con inserti in plastica antigraffio

- Application: 20"-29" bikes
- Material: Aluminum + Steel + PA + TPE
- Weight: 2.6kg
- Adjustable height: 58~94cm
- Foldable (space saving)
- 360° rotating clamp
- Plier with scratch-resistant plastic inserts

- Aplicación: bicicletas de 20"-29"
- Material: Aluminio + Acero + PA + TPE
- Peso: 2,6 kg
- Altura ajustable: 58 ~ 94 cm
- Plegable (ahorro de espacio)
- abrazadera giratoria de 360°
- Alicates con inserciones de plástico resistentes a los arañazos



Cod. 05.088.125

€ 27,⁹⁵

SUPPORTO TELESCOPICO PER BICI, IN ALLUMINIO TELESCOPIC BIKE STAND, IN ALUMINUM SOPORTE DE BICICLETA TELESCÓPICO, DE ALUMINIO



- Capacità max: 20 kg
- Altezza regolabile: 68~122cm
- Ripiegabile (salvaspazio)
- Supporto rotante a 360°
- Materiale: alluminio + PP + PA

- Max capacity: 20kg
- Adjustable height: 68~122cm
- Foldable (space saving)
- 360° rotating support
- Material: Aluminum + PP + PA

- Capacidad máxima: 20 kg
- Altura ajustable: 68~122cm
- Plegable (ahorro de espacio)
- Soporte giratorio de 360°.
- Material: Aluminio + PP + PA



tutte le immagini dei prodotti pubblicate in questo catalogo sono puramente indicative e possono essere cambiate senza preavviso.
All product images published in this catalogue have explanatory purposes and can be changed with no warning.

Cod. 05.073.22 € **4,98**

Cod. 05.073.21 € **4,50**

Min. ordine 12 pz
Min. order 12 pcs
Pedido minimo 12 uds.

**FINE SERIE
SELL OUT**

COB LED LAMP



Min. ordine 12 pz
Min. order 12 pcs
Pedido minimo 12 uds.



**Espositore incluso
Display included
Exhibidor incluido**

**FINE SERIE
SELL OUT**

COB PEN LIGHT



**Espositore incluso
Display included
Exhibidor incluido**



EVERSMART

Cod. 05.060.00 € **29,90**

CAVO DI SOCCORSO ELETTRONICO
protetto contro inversioni e corti circuiti (brevettato)
conforme normativa CE e SAE

INTELLIGENT BOOSTER CABLE
against inversions and short circuits (patented)
In conformity with CE and SAE standards

CABLE DE SOCORRO ELECTRÓNICO
protegido contra las inversiones de polaridad y los
cortocircuitos (con patente) de conformidad
con las normativas CE y SAE

Cod. 03.000.42 € **79,00**

**COMPRESSORE D'ARIA
AIR COMPRESSOR
COMPRESOR DE AIRE**



**MAX
10.3 BAR**
12V 30A



Cod. 05.096.04 € **4,50**

Prezzi netti per quantità
Net prices for min. q.ty



**INPUT 12V - 24V DC
DUAL OUTPUT:
5 V DC = 2,1 A
5 V DC = 1 A**

Cod. 05.096.03 € **10,90**

**VOLTIMETRO DIGITALE DA AUTO
DIGITAL VOLTMETER FOR VEHICLES
VOLTÍMETRO DIGITAL PARA VEHÍCULOS**



Permette un controllo costante dello stato della batteria
attraverso la presa accendisigari. Confezione in blister

It allows to check constantly on the battery status
through the cigar lighter socket. Supplied in blister
package

Permette un controllo costante dello stato della batteria
attraído la presa accendisigari. Confezione en blister

Tutte le immagini dei prodotti pubblicate in questo catalogo sono puramente indicative e possono essere cambiate senza preavviso.
All product images published in this catalogue have explanatory purposes and can be changed with no warning.

Prezzi promozionali / IVA e trasporto non incluso • Promotional prices • Precios promocionales

PROMO 2024

161

PROMO 2024

Cod. 03.024.34

€ 36,⁹⁰

CBA 400 PRO

CARICABATTERIE INTELLIGENTE
SMART BATTERY CHARGER
CARGADOR DE BATERIA INTELIGENTE



- Corrente di carica: 6V: 2A; 12V: Lenta 2A / Veloce 4A
- Voltaggio della batteria: 6V/12V, Max. Potenza: 70W
- Tensione AC: 220VAC-240VAC, 50Hz
- Tipi di batterie: tutti i tipi di batterie al piombo-acido (WET, MF, Ca/Ca, AGM e GEL)
- Tipo di caricabatterie: 7 fasi, ciclo di ricarica completamente automatico
- Classe di isolamento: IP65
- Cavo: 1,5mt
- Caratteristiche intelligenti di ricarica a 7 fasi
- Funzione DIAGNOSI e RESCUE
- Diverse funzioni di protezione: inversione di polarità / surriscaldamento / cortocircuito / bassa tensione / sovraccarico
- Morsetti a coccodrillo di alta qualità
- Modalità Freddo: per consentire la carica e mantenere le batterie a basse temperature

- Charging current: 6V: 2A; 12V: Slow 2A / Fast 4A
- Battery voltage : 6V/12V, Max. Power: 70W
- Voltage AC: 220VAC-240VAC, 50Hz
- Battery Types: All type of lead-acid batteries WET, MF, Ca/Ca, AGM and GEL)
- Charger type: 7-Step, Fully automatic charging cycle
- Insulation class: IP65
- Cable: 1.5M
- 7-step intelligent charging characteristics
- DIAGNOSIS and RESCUE function
- Various Protection Functions: Reverse polarity / Over heat / Short Circuit / Low voltage / Over charge
- High-quality crocodile clamps
- Cold Mode: to allow charge and maintain batteries at low temperatures

Cod. 05.088.67

€ 27,⁹⁰

CARRELLO PORTA GOMME DA NEVE (CON CERCHIONI) TIRE STORAGE RACK SOPORTE PARA NEUMÁTICOS CON RUEDAS



- Capacità: 4 pneumatici da 225;
- Capacità: 125 kg
- Struttura in acciaio verniciato
- 5 ruote, 2 con freno
- Confezione standard: 4 carrelli
- Peso unitario: 3,5 kg

- Capacity: 4 tires;
- Load capacity: 125kgs
- Steel tubing with power-coated steel base for strength and durability
- 5 wheels (2 with brake);
- Net weight of one unit: 3.5 Kgs

- Capacidad: 4 neumáticos
- Capacidad de carga: 125kgs
- Tubos de acero con base de acero revestido para la resistencia y la durabilidad
- 5 ruedas (2 con freno)
- Peso neto una unidad: 3,5kgs

RECUPERA SPAZIO
NEL TUO GARAGE!

SAVE SPACE IN YOUR
HOME GARAGE!

¡AHORRA ESPACIO EN TU
GARAJE!

Cod. 05.088.60

€ 88,⁰⁰

PORTA PNEUMATICI DA PARETE WALL TIRE HOLDER SOPORTE NEUMATICOS DE PARED



- Dimensions: 72x74x167cm
- Weight: 15kgs (assembled)
- Dimensiones: 72x74x167cm
- Peso: 15kgs (montado)
- Dimensioni: 72x74x167cm
- Peso: 15kgs (montato)

Cod. 05.088.68

€ 28,⁷⁰

SUPPORTO PER PNEUMATICI TYRES HOLDER SOPORTE NEUMÁTICOS



- Dimensioni di apertura: 120x44x101cm
- L'altezza è regolabile da 0 a 100cm, asta centrale regolabile
- Il supporto può contenere 8 pneumatici 215/55
- Carico massimo: 150kgs
- Imballo: 121x7x8cm

- Opening dimensions: 120x44x101cm
- adjustable height from 0 to 100 cm, adjustable central bar
- The stand can hold 8 pcs of 215/55 tires
- Maximum load: 150kgs
- Packaging: 121x7x8cm

Tutte le immagini dei prodotti pubblicate in questo catalogo sono puramente indicative e possono essere cambiate senza preavviso.
All product images published in this catalogue have explanatory purposes and can be changed with no warning.

Cod. 03.036.04

€ 13,00

TANICA SCARICA OLIO ESAUSTO (15LT)
TANK TO DISCHARGE EXHAUST OIL (15LT)
TANQUE PARA LA DESCARGA DE ACEITE USADO (15LT)



- Temperatura di lavoro -30°/+80°C
- Comode maniglie anteriore e posteriore
- Sufficiente per tutte le applicazioni
- Working temperature -30°/+80°C
- Comfortable front and rear handles
- Capacity enough for all the applications
- Temperatura de funcionamiento -30°/+80°C
- Cómodas asas, delantera y posterior
- Suficiente para todas las aplicaciones

Cod. 05.008.01

€ 6,50

VASSOIO MAGNETICO DOPPIO
DOUBLE MAGNETIC PART DISH
BANDEJA MAGNÉTICA DOBLE

- 240x140 mm



Cod. 05.088.70

€ 21,90

- 450x80x320 mm

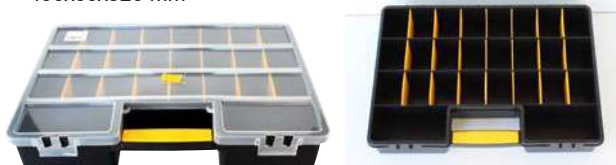

Cod. 05.088.69

€ 17,90

- 360x65x280 mm



Cod. 05.056.20

€ 3,90

MIN. ORDINE 5 PZ. / MIN. ORDER 5 PCS

CHIAVE UNIVERSALE PER FILTRI OLIO/GASOLIO
 regolabile 50-100mm diametro

OIL FILTER STRAP WRENCH
 adjustable 50-100mm diameter

LLAVE UNIVERSAL PARA FILTROS DE ACEITE / DIESEL
 50-100 mm de diámetro ajustable



Cod. 05.090.98

€ 22,00

SET DI 36 CHIAVI ESAGONALI CON IMPUGNATURA
36 PCS HEX & TORX KEY SET WITH T-HANDLE

- 13 Pcs Inch (3/64" - 3/8")
- 13 Pcs Metric (1.27-10mm)
- 9 Pcs Star (T10 -T50)



Cod. 05.088.129

€ 16,00

COPPIA FINE CORSA IN PLASTICA PER PARCHEGGI
 52.8x25x5.2 cm; 0.62 kg

COUPLE OF GARAGE PARKING FLOOR MATS
 52.8x25x5.2 cm; 0.62 kg

PAR DE TAPETES DE PLÁSTICO PARA ESTACIONAMIENTO EN GARAJE
 52.8x25x5.2 cm; 0.62 kg



Tutte le immagini dei prodotti pubblicate in questo catalogo sono puramente indicative e possono essere cambiate senza preavviso.
 All product images published in this catalogue have explanatory purposes and can be changed with no warning.



Cod. 05.088.109W

€ 128,00

CARRELLO 3 PIANI TIPO PESANTE / 3-LEVEL HEAVY DUTY TROLLEY

- carrello in acciaio verniciato (uso industriale)
- 2 ruote fisse, 2 piroettanti Ø125 mm con freno
- tappeti in gomma antiolio
- portata 300 kg
- Fornito con il kit di montaggio
- trolley in painted steel (industrial use)
- 2 Fixed wheels, 2 pivoting 125 mm diameter with brake
- Anti-oil rubber mats
- capacity 300 kgs
- In mounting kit



Cod. 05.083.03

€ 46,00

**SGABELLO REGOLABILE CON PORTAUTENSILI
ADJUSTABLE STOOL WITH TOOL-HOLDER
TABURETE AJUSTABLE CON PORTAHERRAMIENTAS**

- Portata / Capacity / Capacidad: 130Kg
- Altezza max / Max. height / Longitud max: 540mm
- Altezza min / min. height / Longitud min.: 420mm



Cod. 05.083.02

€ 26,40

**SGABELLO FISSO CON QUATTRO RUOTE E PORTA UTENSILI
STOOL WITH FOUR WHEELS AND TOOLS-HOLDER
TABURETE CON CUATRO RUEDAS Y PORTA-HERRAMIENTAS**

- Weight / Peso: 3,8kgs
- Dim:360x365x365mm



Cod. 05.088.02

€ 62,00

CARRELLO 3 PIANI / 3-LEVEL TROLLEY

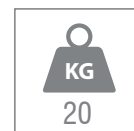

Cod. 05.083.04

€ 26,00

**CARRELLO PORTA ATTREZZI DA PAVIMENTO SU RUOTE, CON SPECCHIO
FLOOR TOOL-HOLDER ON WHEELS, WITH THE MIRROR
PORTAHERRAMIENTAS DE SUELO SOBRE RUEDAS, CON ESPEJO**

- Dimensioni: 468mm
- Altezza: 110mm
- Capacità: 100kg
- Peso: 1,4 kg
- Imballo: 47x47x6mm

- Dimensions: 468mm
- Height: 110mm
- Capacity: 100kg
- Weight: 1.4 kg
- Imballo: 47x47x6mm

- Dimensiones: 468 mm
- Altezza: 110 mm
- Capacidad: 100 kg
- Peso: 1,4 kg
- Imballo: 47x47x6mm

SPECCHIO / MIRROR / ESPEJO



TRUCK



CAR



BIKE

Cod. 05.090.14

€ 27,00

**SET 12 CACCIAVITI CON ESAGONO ESTERNO
per una maggior coppia, usando una chiave a bussola**

**SCREWDRIVER KIT, 12PCS, END-TO-END HEX BLADE
with outer hexagon for extra torque using a spanner or socket**

**JUEGO DE 12 DESTORNILLADORES CON HEXÁGONO EXTERNO
para más torque, usando una llave de tubo**



Tutte le immagini dei prodotti pubblicate in questo catalogo sono puramente indicative e possono essere cambiate senza preavviso.
All product images published in this catalogue have explanatory purposes and can be changed with no warning.

Cod. 03.000.49

€ 29,00

**PISTOLA DI SOFFIAGGIO CON 6 UGELLI LATERALI**

per pulizia condotti, filtri aria veicoli commerciali, fuoristrada, macchine agricole. Lunghezza utile: 16" (407mm)

BLOW GUN WITH 6 LATERAL NOZZLES

for the cleaning of ducts and air filters on commercial vehicles, off-road vehicles, agricultural machinery.
Working Length: 16" (407mm)

PISTOLA DE SOPLADO CON 6 BOQUILLAS LATERALES

para la limpieza de conductos y filtros de aire en los vehículos comerciales, vehículos todo terreno, maquinaria agrícola.
Longitud de trabajo: 16" (407mm)

Cod. 05.084.21

€ 65,00

**KIT CRICCO IDRAULICO 2 TON PER PRONTO INTERVENTO**

con ferma ruote e tappetino, guanti e valigia di trasporto

2 TON HYDRAULIC JACK FOR EMERGENCY USE

with wheel stops and mat, gloves and transport case

GATO HIDRÁULICO DE 2 TONELADAS PARA USO DE EMERGENCIA

con bloques de ruedas y alfombrilla, guantes y maletín de transporte



- **Idoneo per USO PRIVATO**
- Peso netto/lordo: 9,55/10,96kg
- Dimensioni imballo: 50 x 23 x 16 cm
- **Suitable for PERSONAL USE**
- Peso neto/bruto: 9,55/10,96kg
- Dimensiones del embalaje: 50 x 23 x 16 cm

- **Adecuado para USO PRIVADO**
- Net/gross weight: 9,55/10,96kg
- Package dimensions: 50 x 23 x 16 cm

Cod. 04.052.07

€ 32,00

**RILEVATORE DIGITALE**

cercametalli e rilevatore di cavi elettrici ac

DIGITAL FINDER

for metal, ac wiring, wood

DETECTOR DIGITAL

de metales y detector de cables electricos ac

CARATTERISTICHE TECNICHE:

- Display LCD con indicatore acustico
- Individua rivestimenti in legno fino a 38mm
- Individua tubi in metallo fino a 76mm
- Individua cavi elettrici (AC) fino a 76mm
- Autocalibrazione
- Alimentazione: 1 batteria 9V (non fornita)
- Confezione in blister

TECHNICAL FEATURES::

- LCD display and audio indicator
- Wood detection up to 38mm
- Metal pipes detection up to 76mm
- AC live wires detection up to 76mm
- Auto calibration
- Power supply: 6F 22 9V battery (not supplied)
- Blister packaging

Rivenditore • Distributor • Distributeur • Einzelhändler • Distribuidor • Фирма-продавец

Stampato/printed: 02/2024

MARCO[®]
TOOLS
BY SPIN

**PROMO
2024**

VALIDITÀ 01/03/2024
VALIDITY • VALIDEZ 31/12/2024

SPIN s.r.l.
Via Casalecchio 35/G - 47924 Rimini (RN) Italy
Tel. +39 0541.730777
info@spinsrl.it - www.spinsrl.it

COMPANY WITH
QUALITY SYSTEM
CERTIFIED BY DNV GL
= ISO 9001 =

MARCO TOOLS è un marchio distribuito da SPIN srl, produttore di autoattrezzature per le officine dal 1979 a Rimini

MARCO TOOLS is a trade mark distributed by SPIN srl, manufacturer of garage equipment since the 1979 in Rimini - Italy

MARCO TOOLS est une marque distribuée par la société SPIN srl, producteur d'équipement de garage du 1979 à Rimini - Italie

MARCO TOOLS ist eine Vertriebsmarke der Firma SPIN srl, Hersteller von der Werkstatteinrichtung seit 1979 in Rimini, Italien

MARCO TOOLS es una marca distribuida por SPIN srl, fabricantes desde 1979 de equipamientos para talleres en Rimini, Italia